



1992

BMW 325i Convertible

Electrical

Troubleshooting

Manual

Final Edition
BMW of North America, Inc.
Woodcliff Lake, New Jersey

FOREWORD

In the interests of continuing technical development work we reserve the right to modify designs and equipment

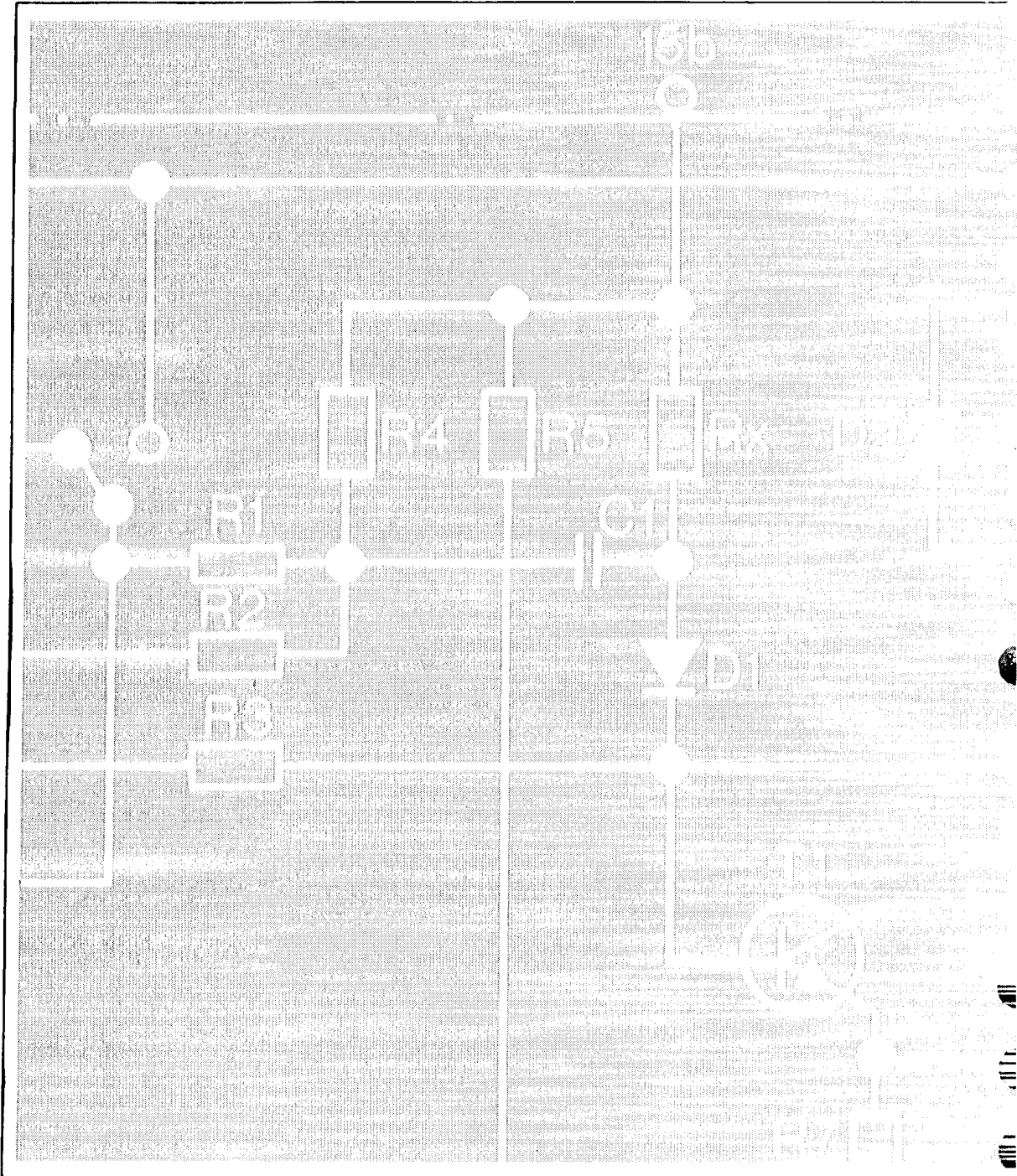

Printed in USA

©Copyright BMW of North America, Inc.

Not to be reproduced wholly or in part without written permission of BMW of North America, Inc.

PN 01 00 1 467 928

**1992
BMW 325i Convertible
Electrical
Troubleshooting
Manual**

CONTENTS

Index	2
How To Use This Manual . .	3
Wire Size Conversion Chart .	3
Symbols	4
Systematic Troubleshooting	6
Connector Views. 8500-0	
Power Distribution Box 0670-0	
Fuse Data 0670-1	
Component Location Chart . 9000-0	
Component Location Views 7000-0	
Splice Location Views 8000-0	

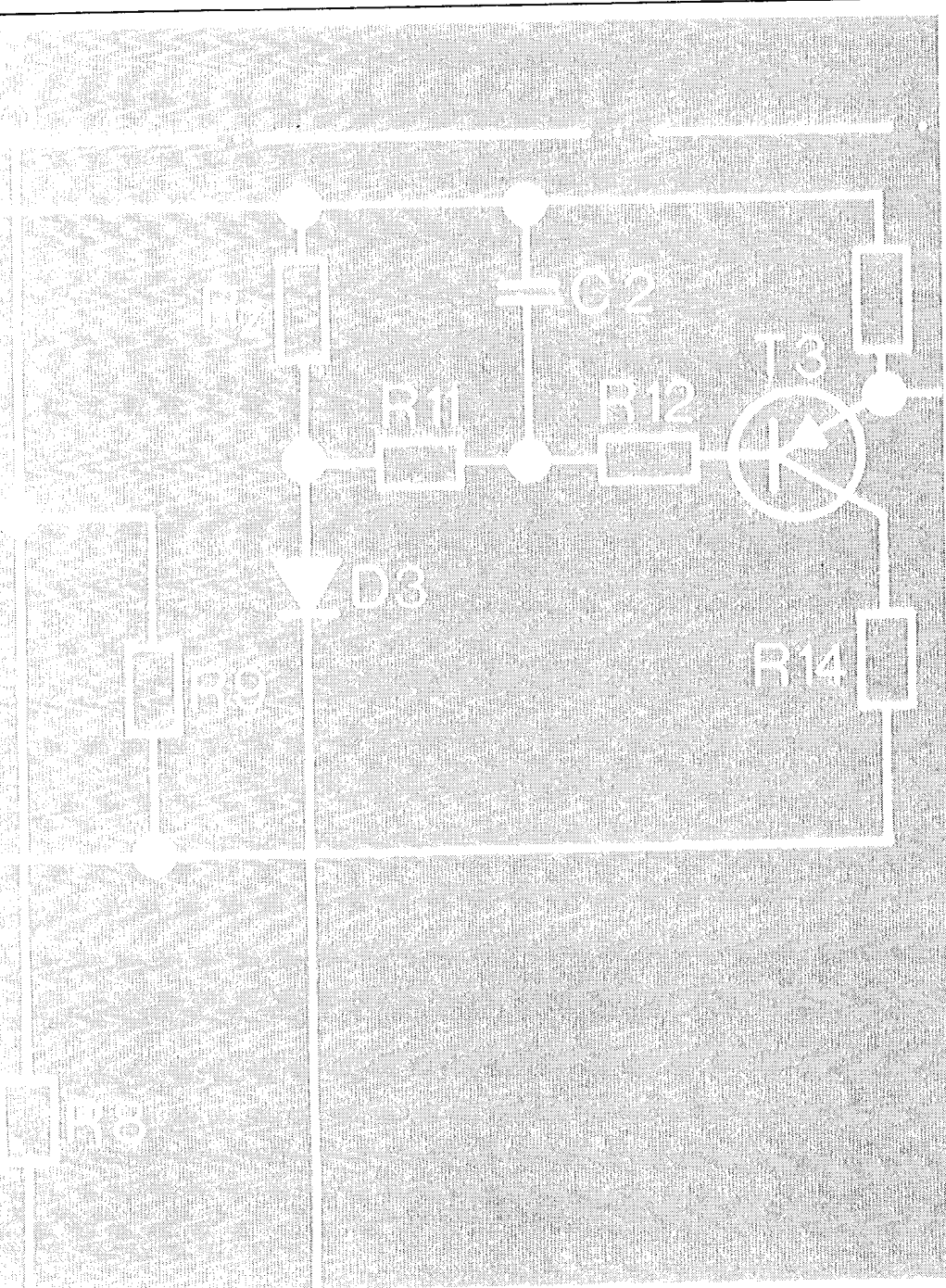

Fig. 10

Index — Alphabetical Listing of Electrical Circuits

	PAGE		PAGE		PAGE
Active Check Control	6216-0	— G201	0670-14	— Fog	6312-0
A/C Air Delivery Control	6421-0	— G202	0670-15	— Front Side Marker	6314-0
A/C Blower Controls	6413-0	— G202	0670-16	— Front Turn/Park	6314-0
A/C Compressor Controls	6452-0	— G203	0670-15	— Glove Box	6100-1
A/C Temperature Control	6411-0	— G300	0670-16	— Hazard Switch	6313-0
Antilock Braking System (ABS)	3450-0	— G303	0670-17	— Headlights	6312-0
Auto-Charging Flashlight	6100-1	— G304	0670-17	— Instrument Cluster	6300-2
Auxiliary Fan	6454-0	Heated Seats	5200-0	— Interior	6330-0
Auxiliary Fuse	0670-2	Horns	6100-0	— License	6320-0
Brake Warning System	3435-0	Ignition Key Warning	6131-0	— Map Reading Light	6100-1
Central Locking	5126-0	Indicators		— Park	6314-0
Charge System	1230-0	— Active Check Control Alarm	6216-2	— Rear Side Marker	6320-0
Cigar Lighter	6100-1	— "Anti-Lock"	3450-0	— Stop	6325-0
Component Location Chart	9000-0	— "Brake Lights" Fault	6216-1	— Tail	6314-0
Component Location Views	7000-0	— "Brake Lining" Wear	3435-0	— Trunk	6320-0
Connector Views	8500-0	— "Brake" Warning	3435-0	— Turn/Hazard	6313-0
Cruise Control	6571-0	— Charge	1230-0	Light Switch Details	6300-0
Electro-Mechanical Convertible		— "Coolant" Level Fault	6216-2	On-Board Computer	6581-0
Top	5400-0	— "Engine Oil" Fault	6216-2	Power Antenna	6500-0
Fuel Economy Gauge	6210-3	— Fasten Seatbelts	6216-2	Power Distribution	0670-0
Fuel Gauge	6210-1	— Fog Lights	6312-0	Power Distribution Box	0670-0
Fuse Data Chart	0670-1	— High Beam	6312-1	Power Mirrors	5116-0
Fuse Details		— Inspection	6210-2	Power Windows	5133-0
— Fuse 4	0670-6	— LH Turn	6313-1	Radio	6500-0
— Fuse 5	0670-6	— "License Plate" Fault	6216-1	Rear Defogger	6100-2
— Fuse 6	0670-6	— "Low Beam" Fault	6216-0	Seatbelt Warning	6131-0
— Fuse 8	0670-7	— Low Fuel Warning	6210-1	Service Interval Indicator	6210-2
— Fuse 9	0670-11	— Oil Pressure Warning	6210-1	Speedometer	6210-0
— Fuse 10	0670-8	— Oil Service	6210-2	Splice Location Views Index	8000-0
— Fuse 12	0670-7	— "Park Brake"	3435-0	Start	
— Fuse 19	0670-7	— "Rear Lights" Fault	6216-1	— Automatic	1240-0
— Fuse 20	0670-9	— RH Turn	6313-1	— Manual	1240-1
— Fuse 21	0670-10	— "Washer Fluid" Fault	6216-2	Supplemental Restraint System	
— Fuse 27	0670-11	Injection Electronics	1360-0	(SRS)	3234-0
Gauges	6210-1	Instrument Cluster	6210-0	Tachometer	6210-3
Ground Distribution		Lights		Temperature Gauge	6210-1
— G103	0670-12	— A/C Control Power	6300-2	Warnings	
— G104	0670-13	— Ashtray, Rear	6300-2	— Ignition Key/Seatbelt	6131-0
— G200	0670-13	— Back Up	6322-0	Wiper/Washer	6160-0
.	0670-14	— Cigar Lighter	6300-2		
.	0670-15	— Dash	6300-2		

The purpose of this manual is to show electrical schematics in a manner that makes electrical troubleshooting easier. Electrical components which work together are shown together on one schematic. The Wiper-Washer schematic, for example, shows all of the electrical components in one diagram. At the top of the page is the fuse (positive) that powers the circuit. The flow of current is shown through all wires, connectors, switches, and motors to ground (negative) at the bottom of the page.

Within the schematic, all switches and sensors are shown "at rest," as though the Ignition Switch were off. For identification, component names are underlined and placed next to or above each component. Notes are included, describing how switches and other components work.

The power distribution schematic shows the current feed through all the connections from the Battery and Alternator to each fuse and the Ignition and Light Switches. If the Power Distribution schematic is combined with any other circuit schematic, a complete picture is made of how that circuit works. The Ground Distribution schematics show how several circuits are connected to common grounds.

All wiring between components is shown exactly as it exists in the vehicle; however, the wiring is not drawn to scale. To aid in understanding electrical operation, wiring inside complicated components has been simplified. The "Solid State" label designates electronic components.

WIRE SIZE CONVERSION CHART	
METRIC (CROSSSECTIONAL AREA IN MM ²)	AWG (AMERICAN WIRE GAUGE)
.5	20
.75	18
1	16
1.5	14
2	14
2.5	12
4	10
6	8
8	8
16	4
20	4
25	2
32	2

WIRE INSULATION	
ABBREVIATIONS	COLOR
BK	BLACK
BR	BROWN
RD	RED
YL	YELLOW
GN	GREEN
BU	BLUE
VI	VIOLET
GY	GRAY
WT	WHITE
PK	PINK

4 SYMBOLS



ENTIRE COMPONENT SHOWN



PART OF A COMPONENT SHOWN

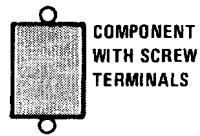

COMPONENT WITH SCREW TERMINALS



SOLID STATE (INCLUDES ONLY ELECTRONIC PARTS)

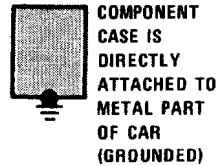

COMPONENT CASE IS DIRECTLY ATTACHED TO METAL PART OF CAR (GROUNDED)

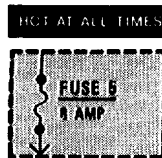

INDICATES THAT FUSE 5 IS ALWAYS SUPPLIED WITH POWER

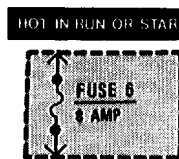

INDICATES THAT FUSE 6 IS SUPPLIED WITH POWER WITH THE IGNITION SWITCH IN THE RUN OR START POSITIONS

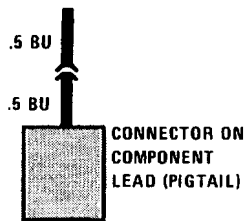
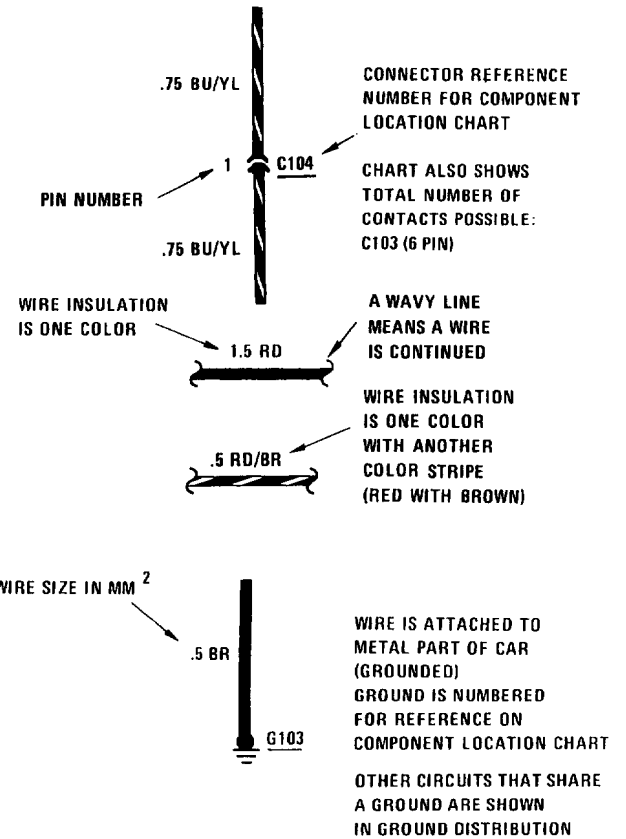

CONNECTOR ON COMPONENT LEAD (PIGTAIL)

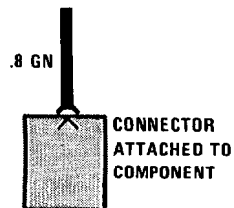

CONNECTOR ATTACHED TO COMPONENT

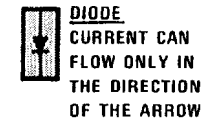
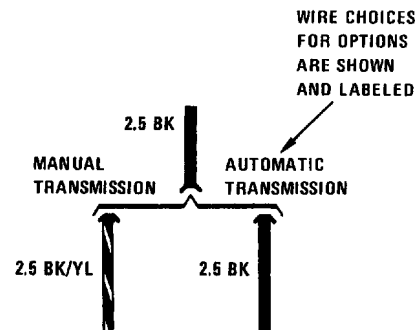

CIRCUIT REFERENCE - A WIRE WHICH CONNECTS TO ANOTHER CIRCUIT





ONE POLE,
TWO POSITION
SWITCH

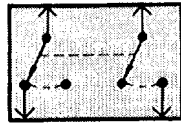

SWITCHES THAT
MOVE TOGETHER
DASHED LINE SHOWS
A MECHANICAL
CONNECTION
BETWEEN SWITCHES

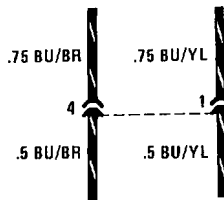

TWO CONNECTIONS
(PINS) IN THE SAME
CONNECTOR

DASHED LINE SHOWS
PARTS OF THE
SAME CONNECTOR



WHEN COIL IS
ENERGIZED, SWITCH
IS PULLED CLOSED

RELAY SHOWN
WITH NO
CURRENT
FLOWING
THROUGH COIL

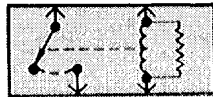

RESISTOR ACROSS COIL
IS FOR NOISE
SUPPRESSION

RELAY SHOWN
WITH RESISTOR
ACROSS COIL

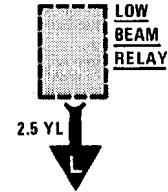
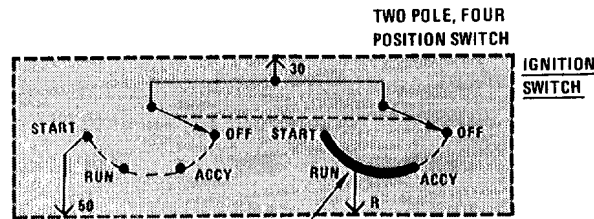
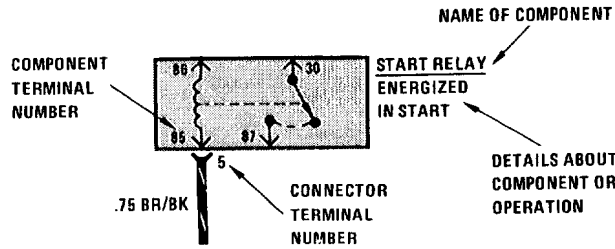

LOW
BEAM
RELAY
2.5 YL
↓
TO POWER
DISTRIBUTION
BOX, PAGE 1

CURRENT PATH
IS CONTINUED
AS LABELED.
THE ARROW SHOWS
DIRECTION OF CURRENT
FLOW AND IS REPEATED
WHERE CURRENT
PATH CONTINUES.

FROM LOW
BEAM RELAY,
PAGE 5
↓

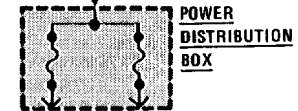

LIGHT
EMITTING
DIODE

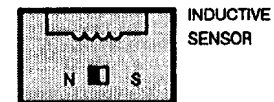
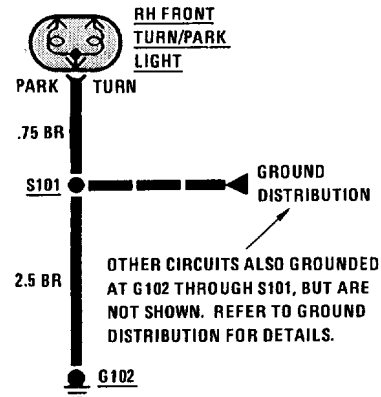

INDUCTIVE
SENSOR

6 SYSTEMATIC TROUBLESHOOTING

TROUBLESHOOTING PROCEDURE

1. Verify the Problem

Operate the problem circuit to check the accuracy of the complaint. Note the symptoms of the inoperative circuit.

2. Analyze the Problem

Refer to the schematic of the problem circuit in the ETM. Determine how the circuit is supposed to work by tracing the current path(s) from the power feed through the circuit components to ground. Then based on the symptoms you noted in step 1 and your understanding of circuit operation, identify one or more possible causes of the problem.

3. Isolate the Problem

Make circuit tests to prove or disprove the preliminary diagnosis made in step 2. Keep in mind that a logical simple procedure is the key to efficient troubleshooting. Test for the most likely cause of failure first. Try to make tests at points which are easily accessible.

4. Repair the Problem

Once the specific problem is identified, make the repair using the proper tools and safe procedures.

5. Check the Problem

Operate the circuit to check for satisfactory circuit operation. Good repair practice calls for rechecking all circuits you have worked on.

TROUBLESHOOTING TOOLS

Isolating the problem (Step 3 of TROUBLESHOOTING PROCEDURES) requires the use of a **voltmeter** and/or **ohmmeter**. A voltmeter measures voltage at selected points in a circuit. An ohmmeter measures a circuit's resistance to current flow. It has an internal battery that provides current to the circuit under test. Disconnect the car battery when using an ohmmeter because the battery voltage will cause the ohmmeter to give false readings. Also, do not use an ohmmeter on solid-state components. The voltage that the ohmmeter applies to the circuit could damage these components.

TROUBLESHOOTING TESTS

Voltage Test

This test measures voltage in a circuit. By taking measurements at several points (terminals or connectors) along the circuit, you can isolate the problem.

To take a voltage measurement, connect the negative lead of the voltmeter to the battery's negative terminal or other known good ground. Then connect the positive lead of the voltmeter to the point you want to test. The voltmeter will measure the voltage present at that point in the circuit.

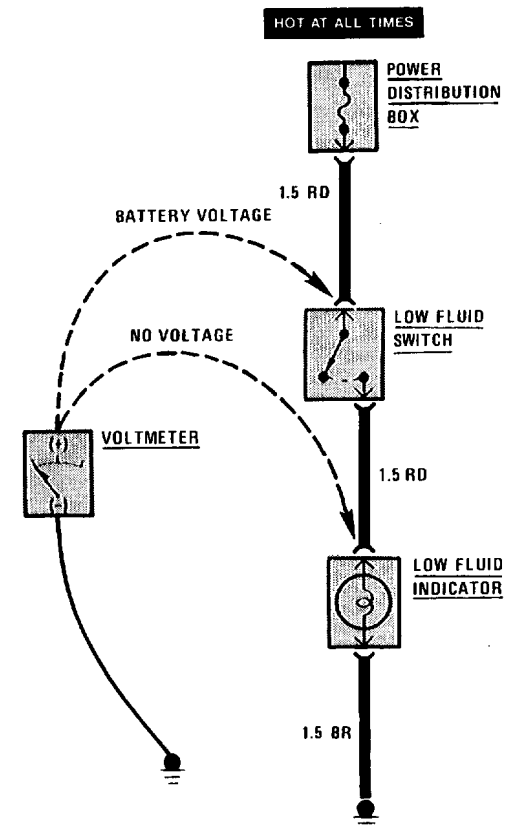

Voltage Test

Voltage Drop Test

Wires, connectors, and switches are designed to conduct current with a minimum loss of voltage. A voltage drop of more than one volt indicates a problem.

To test for voltage drop, connect the voltmeter leads to connectors at either end of the circuit's suspected problem area. The positive lead should be connected to the connector closest to the power source. The voltmeter will show the voltage drop between these two points.

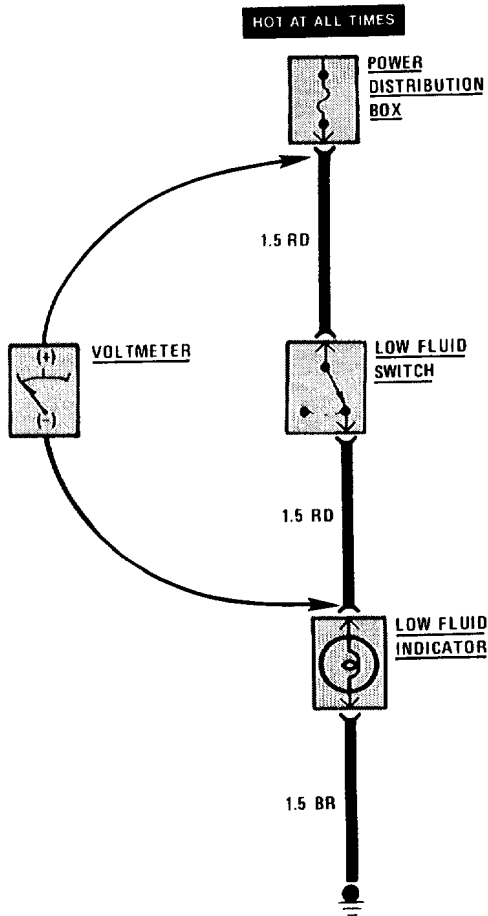

Voltage Drop Test

Continuity Test

To perform a continuity test, first disconnect the car battery. Then adjust the ohmmeter to read zero while holding the leads together. Connect the ohmmeter leads to connector or terminals at either end of the circuit's suspected problem area. The ohmmeter will show the resistance across that part of the circuit.

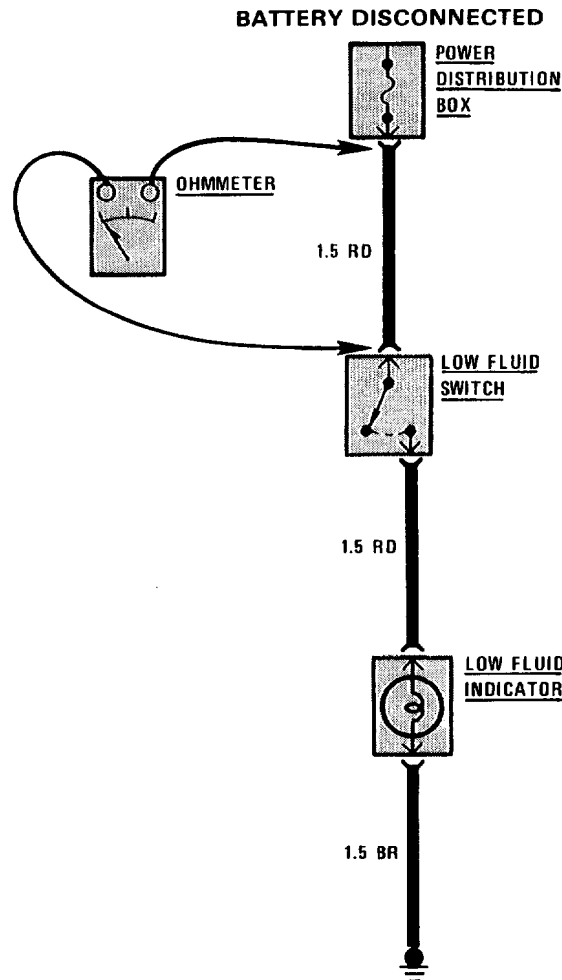

Continuity Test

Short Test Using Voltmeter

Remove the blown fuse and disconnect the load. Connect the voltmeter leads to the fuse terminals. The positive lead should be connected to the terminal closest to the power source.

Starting near the POWER DISTRIBUTION BOX, move the wire harness back and forth and watch the voltmeter reading. If the voltmeter registers a reading, there is a short to ground in the wiring. Somewhere in the area of the harness being moved, the wire insulation is worn away and the circuit is grounding.

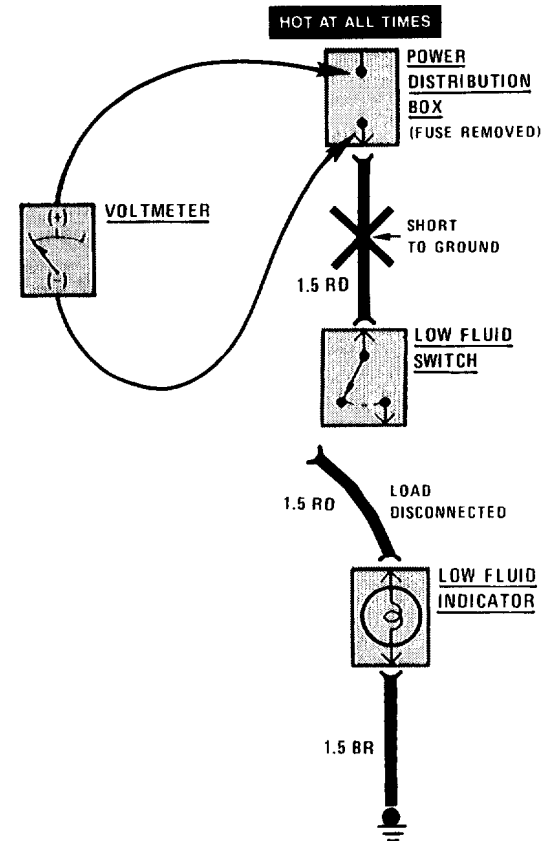

Short Test Using Voltmeter

8 SYSTEMATIC TROUBLESHOOTING

Short Test Using Ohmmeter

Disconnect the battery. Adjust the ohmmeter to read zero while holding the leads together. Remove the blown fuse and disconnect the load. Connect one lead of the ohmmeter to the fuse terminal that is closest to the load. Connect the other lead to a known good ground.

Starting near the POWER DISTRIBUTION BOX, move the wire harness back and forth and watch the ohmmeter reading. Low or no resistance indicates a short to ground in the wiring. Infinitely high resistance indicates no short.

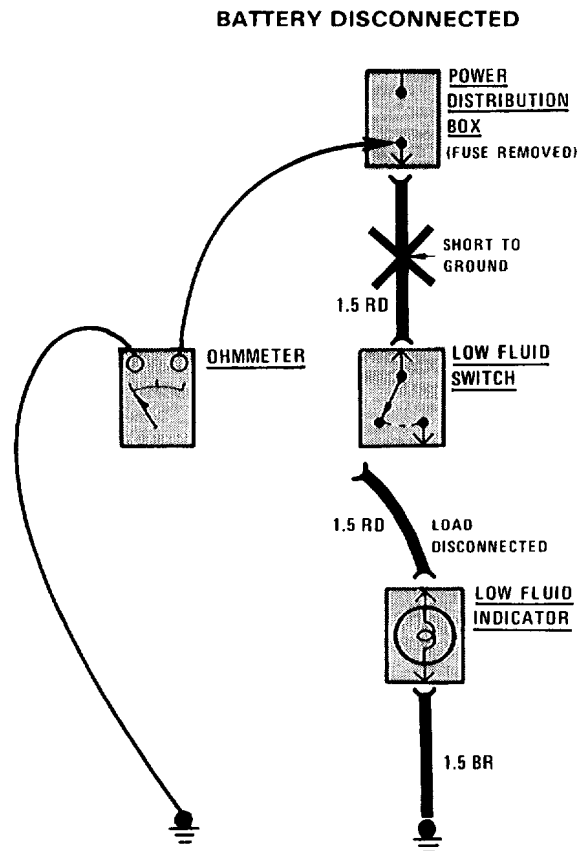

Short Test Using Ohmmeter

0670-0 POWER DISTRIBUTION

POWER DISTRIBUTION BOX

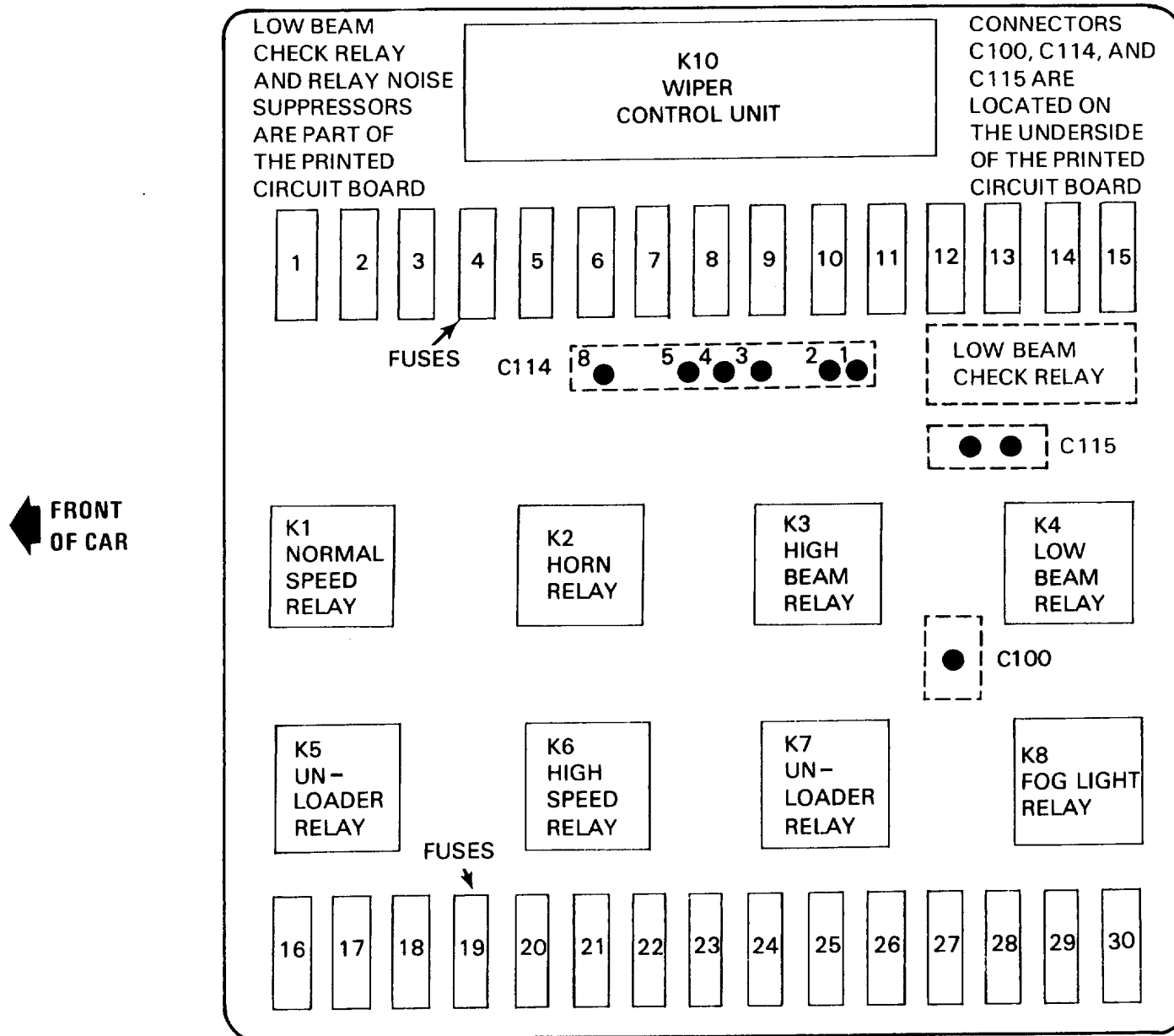

FUSE DATA CHART

FUSE NO.	SIZE	CIRCUIT NAME
1	7.5A	Headlights (also fuses 2, 13, 14); High Beam Indicator.
2	7.5A	Headlights (also fuses 1, 13, 14).
3	15A	Auxiliary Fan (also fuses 18, 19, 20).
4	15A	Lights: Turn/Hazard Warning (also fuse 24); Active Check Control (also fuses 6, 10, 21, 22, 23). Glove Box Light; Electro-Mechanical Convertible Top (also fuse 21, 25).
5	30A	Wiper/Washer.
6	7.5A	Stop Lights Active Check Control (also fuses 4, 10, 21, 22, 23); Antilock Braking System; Cruise Control (also fuse 10); Map Reading Light.
7	15A	Horn.
8	30A	Rear Defogger (also fuse 23).
9	15A	Injection Electronics (also fuses 10, 11, 21).
10	7.5A	Ignition Key Warning/Seatbelt Warning (also Fuse 21); Service Interval Indicator (also fuse 21); Tachometer/Fuel Economy Gauges (also fuse 21); Gauges/Indicators; Brake Warning System; Back Up Lights; On-Board Computer (also fuses 12, 21, 27); Start; Injection Electronics (also fuses 9, 11, 21); Active Check Control (also fuses 4, 6, 21, 22, 23); Cruise Control (also fuse 6).
11	7.5A	Injection Electronics (also fuses 9, 10, 21).
12	7.5A	Radio/Antenna (also fuses 21, 27, 28); Speedometer/Indicators; On-Board Computer (also fuses 10, 21, 27).
13	7.5A	Headlights (also fuses 1, 2, 14).
14	7.5A	Headlights (also fuses 1, 2, 13).
15		Not Used.
16	15A	Heated Seats.
17	30A	Power Windows.
18	30A	Auxiliary Fan (also fuses 3, 19, 20).

FUSE NO.	SIZE	CIRCUIT NAME
19	7.5A	Auxiliary Fan (also fuses 3, 18, 20); Interior Lights (also fuses 21, 27); Power Mirrors.
20	30A	Heater/Air Conditioning; Auxiliary Fan (also fuses 3, 18, 19).
21	7.5A	Auto-Charging Flashlight; Ignition Key Warning/Seatbelt Warning (also fuse 10); Injection Electronics (also fuses 9, 10, 11); Interior Lights (also fuses 19, 27); Radio/Antenna (also fuses 12, 27, 28); Trunk Light; Active Check Control (also fuses 4, 6, 10, 22, 23); Service Interval Indicator (also fuse 10); On-Board Computer (also fuses 10, 12, 23, 27); Tachometer/Fuel Economy Gauge (also fuse 10); Electro-Mechanical Convertible Top (also fuse 4, 25)
22	7.5A	Active Check Control (also fuses 4, 6, 10, 21, 23); Lights: Front Park/Tail (also fuse 23); Lights: Front Side Marker (also fuse 23).
23	7.5A	Lights: Dash; Lights: Front Park/Tail (also fuse 22); Lights: Front Side Marker (also fuse 22); Lights: Rear Marker/License; Active Check Control (also fuses 4, 6, 10, 21, & 22); Rear Defogger (also fuse 8).
24	15A	Lights: Turn/Hazard Warning (also fuse 4).
25	30A	Electro-Mechanical Convertible Top (also fuse 4, 21)
26		Not Used.
27	30A	Interior Lights (also fuses 19, 21); Central Locking; Radio/Antenna (also fuses 12, 21, 28); On-Board Computer (also fuses 10, 12, 21).
28	30A	Cigar Lighter; Radio/Antenna (also fuses 12, 21, 27).
29	7.5A	Fog Lights (also fuse 30), Fog Light Indicator.
30	7.5A	Fog Lights (also fuse 29).
POWER WINDOW CIRCUIT BREAKER		15A Power Windows

0670-2 POWER DISTRIBUTION

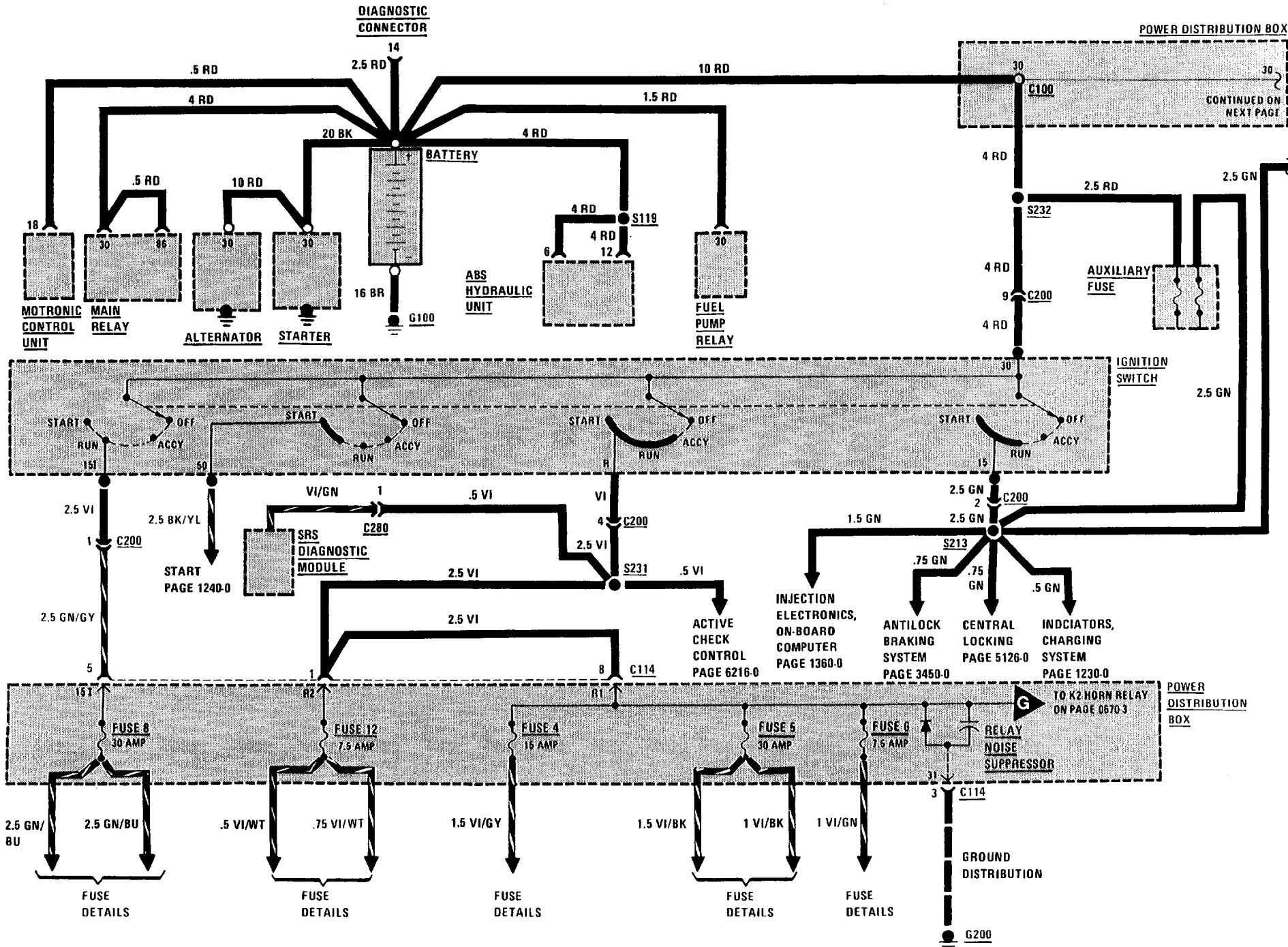

POWER DISTRIBUTION BOX

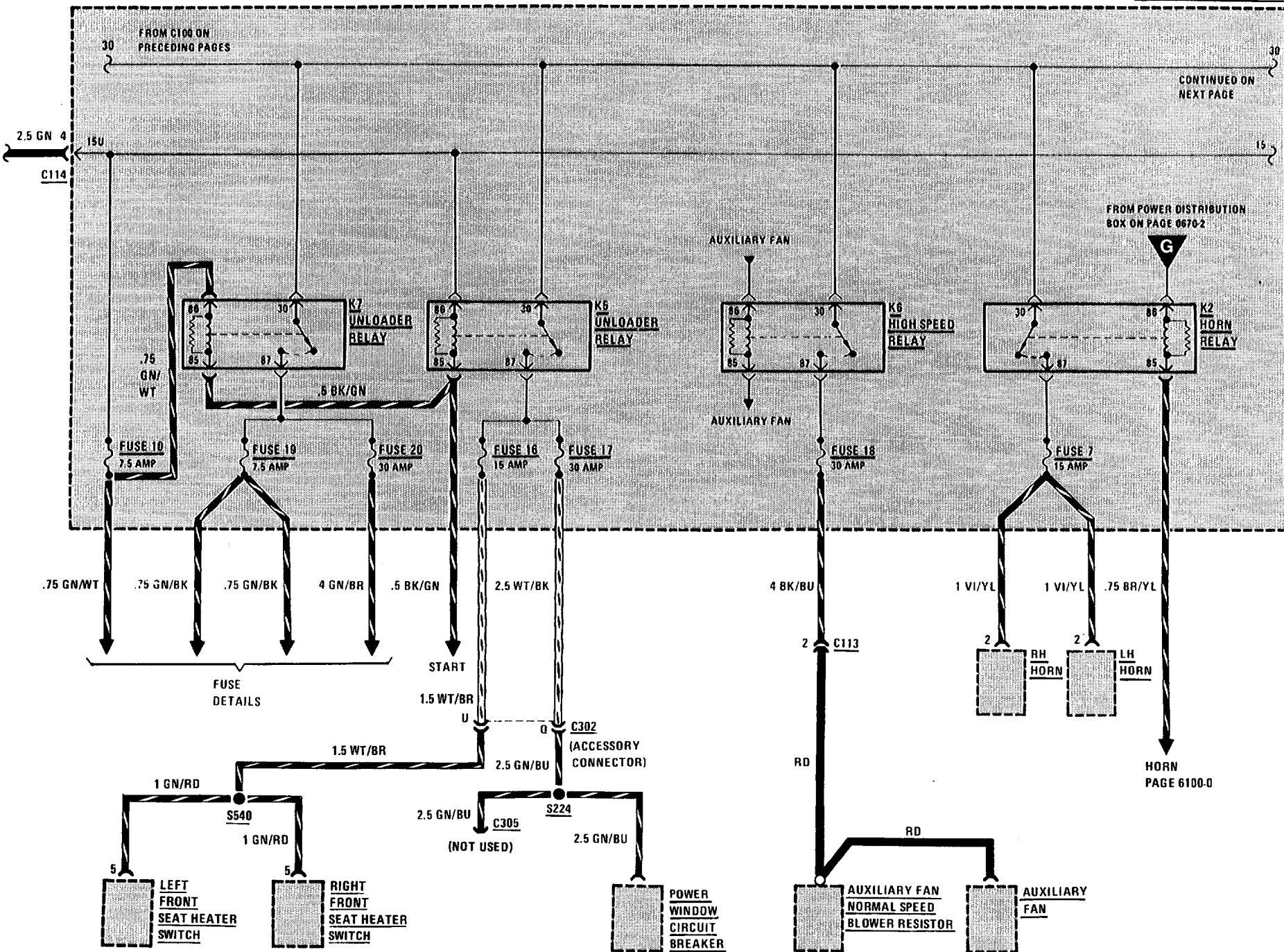

CONTINUED ON NEXT PAGE

FROM POWER DISTRIBUTION BOX ON PAGE 0670-2

FROM C100 ON PRECEDING PAGES

G

FUSE DETAILS

C302 (ACCESSORY CONNECTOR)

(NOT USED)

HORN PAGE 6100-0

LEFT FRONT SEAT HEATER SWITCH

RIGHT FRONT SEAT HEATER SWITCH

POWER WINDOW CIRCUIT BREAKER

AUXILIARY FAN NORMAL SPEED BLOWER RESISTOR

AUXILIARY FAN

RH HORN LH HORN

0670-4 POWER DISTRIBUTION

POWER DISTRIBUTION BOX

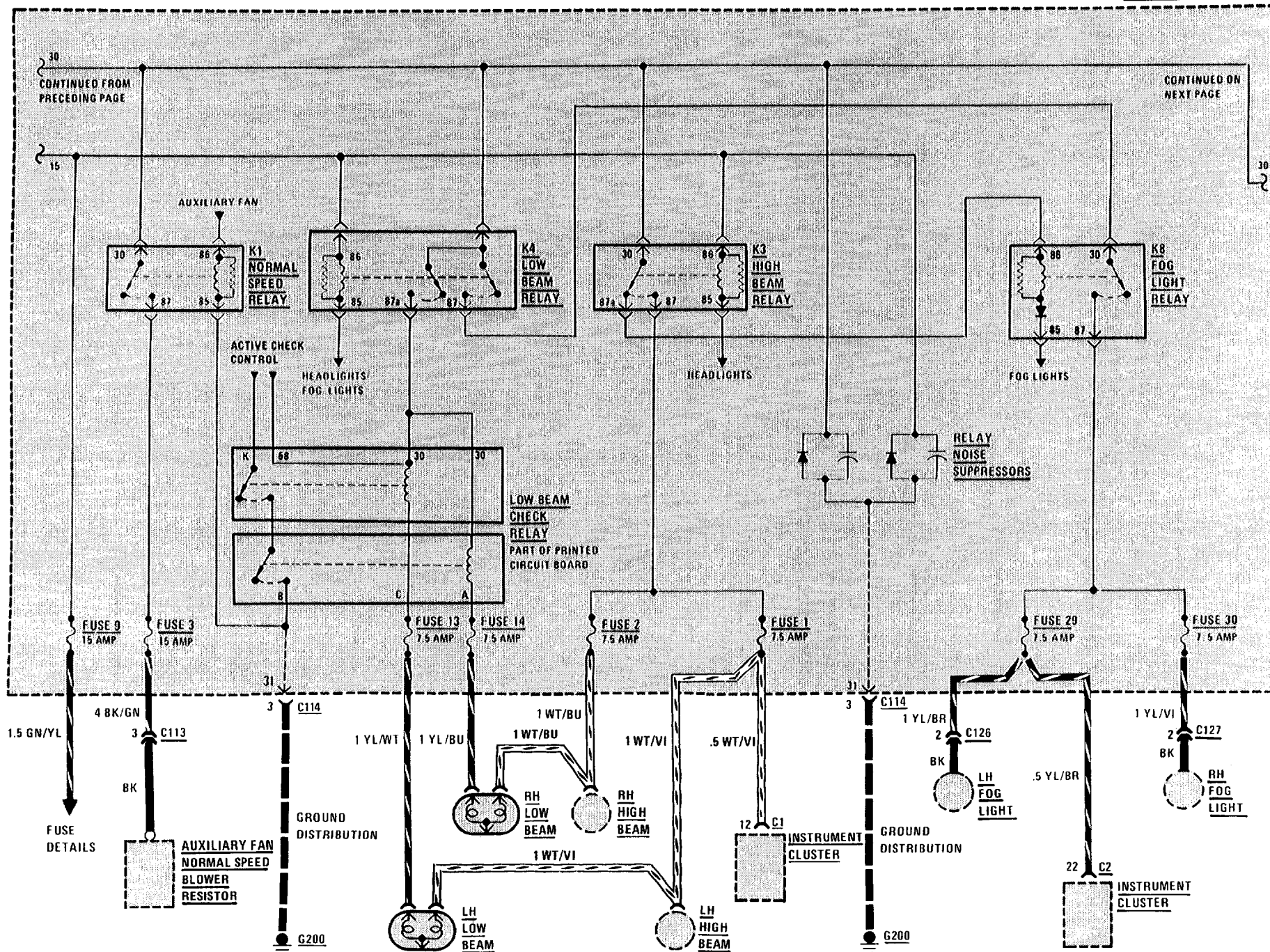

POWER
DISTRIBUTION
BOX

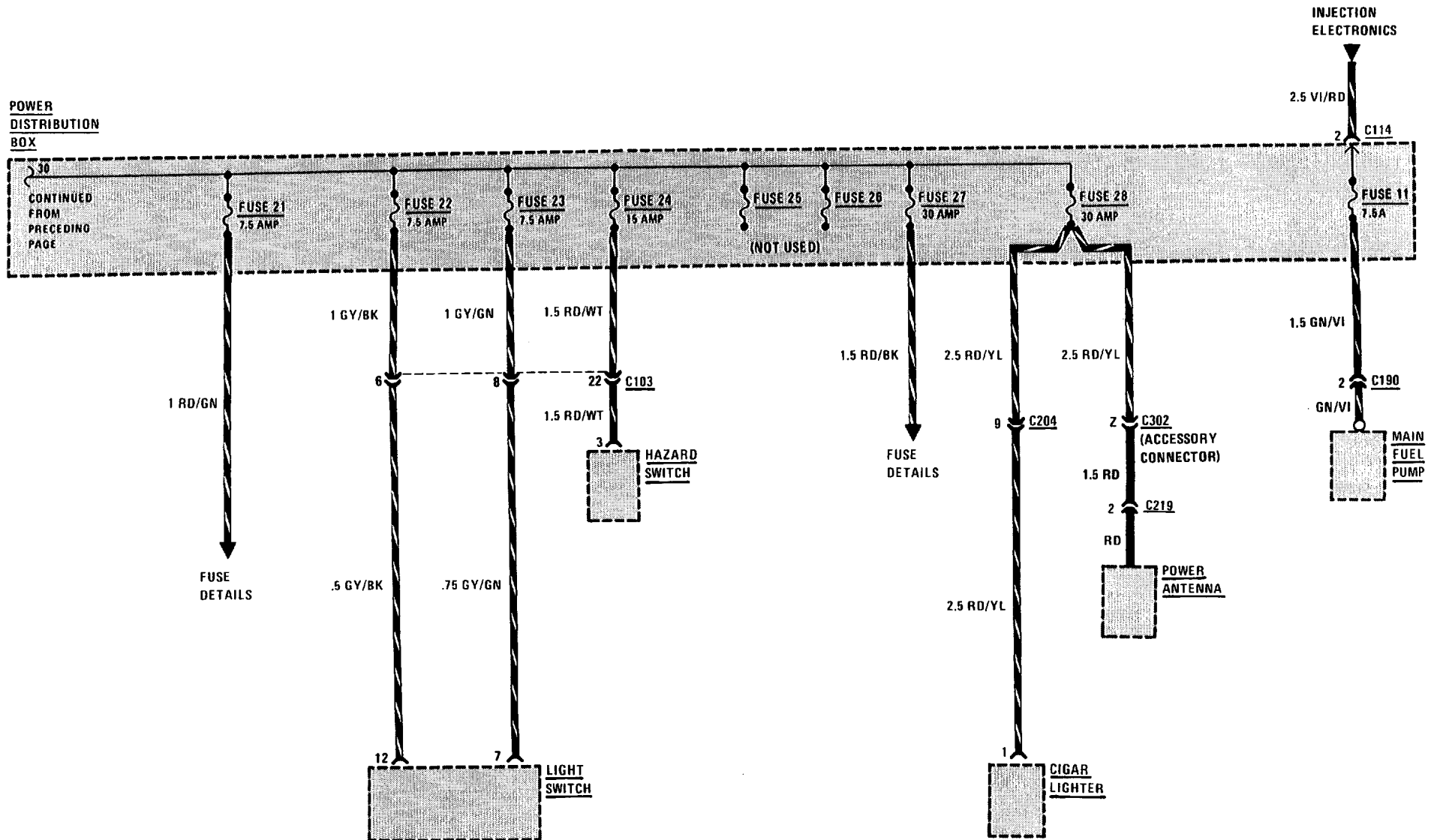

0670-6 POWER DISTRIBUTION

FUSE DETAILS: FUSES 4, 5, AND 6

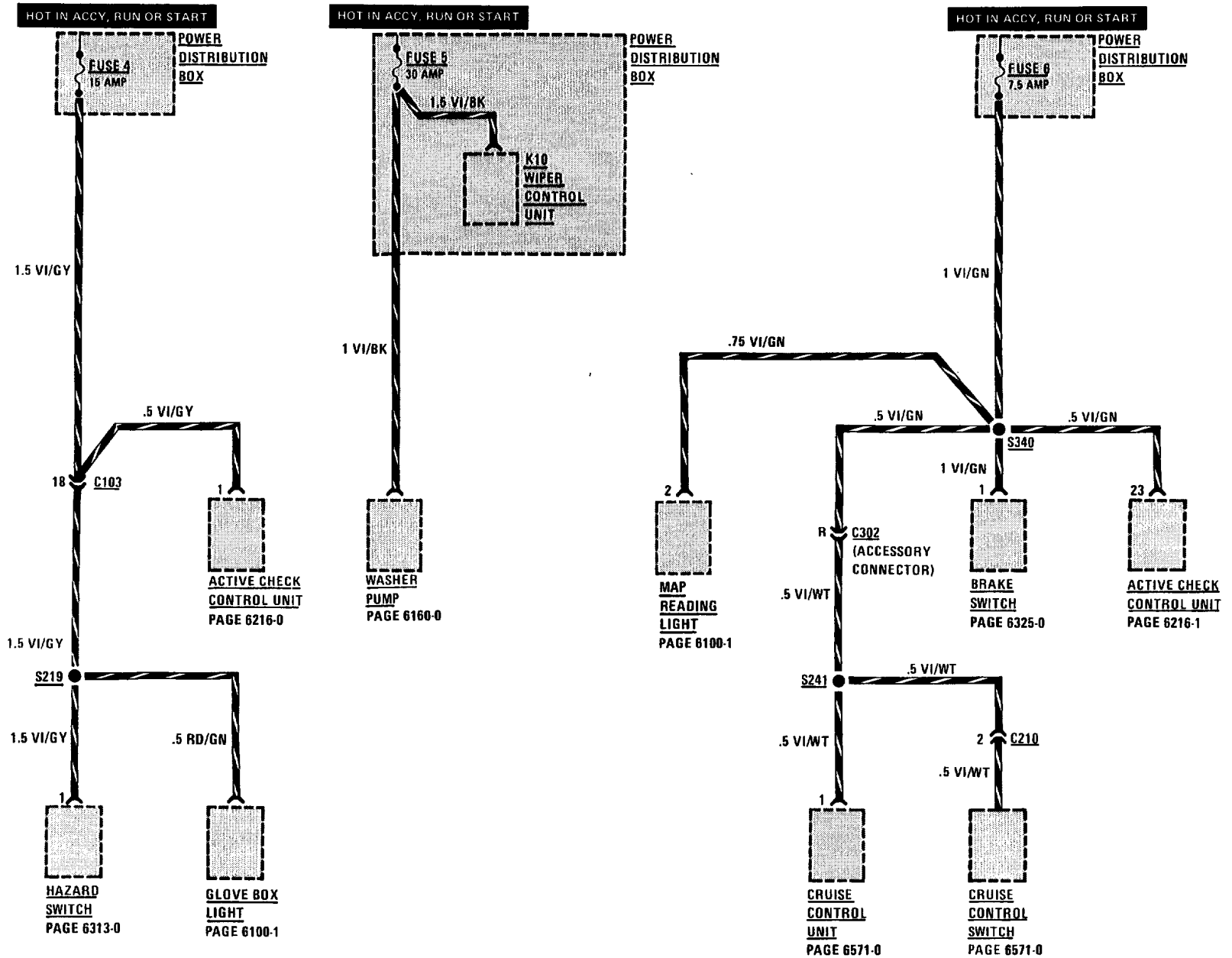

FUSE DETAILS: FUSES 8, 12 AND 19

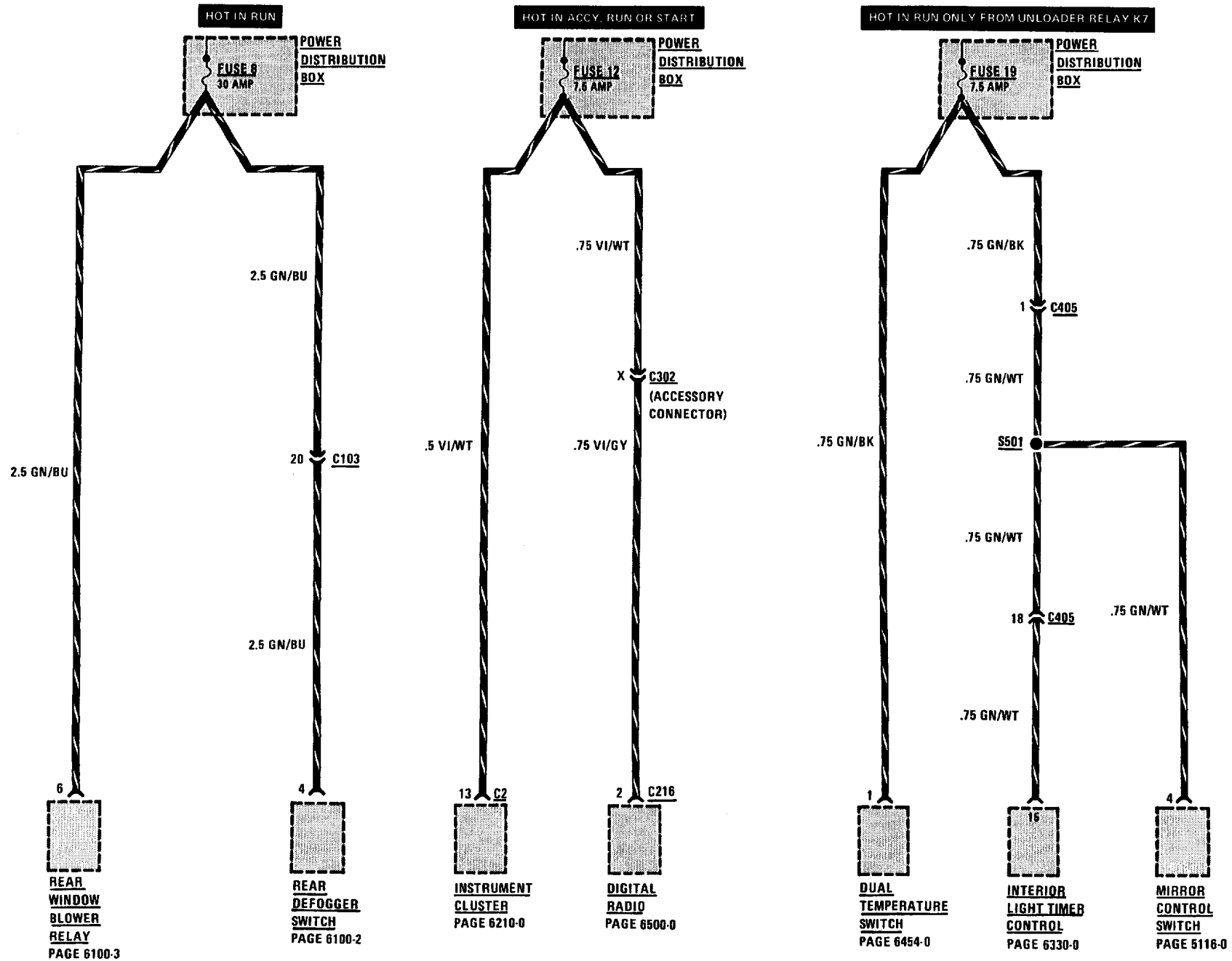

FUSE DETAILS: FUSE 10

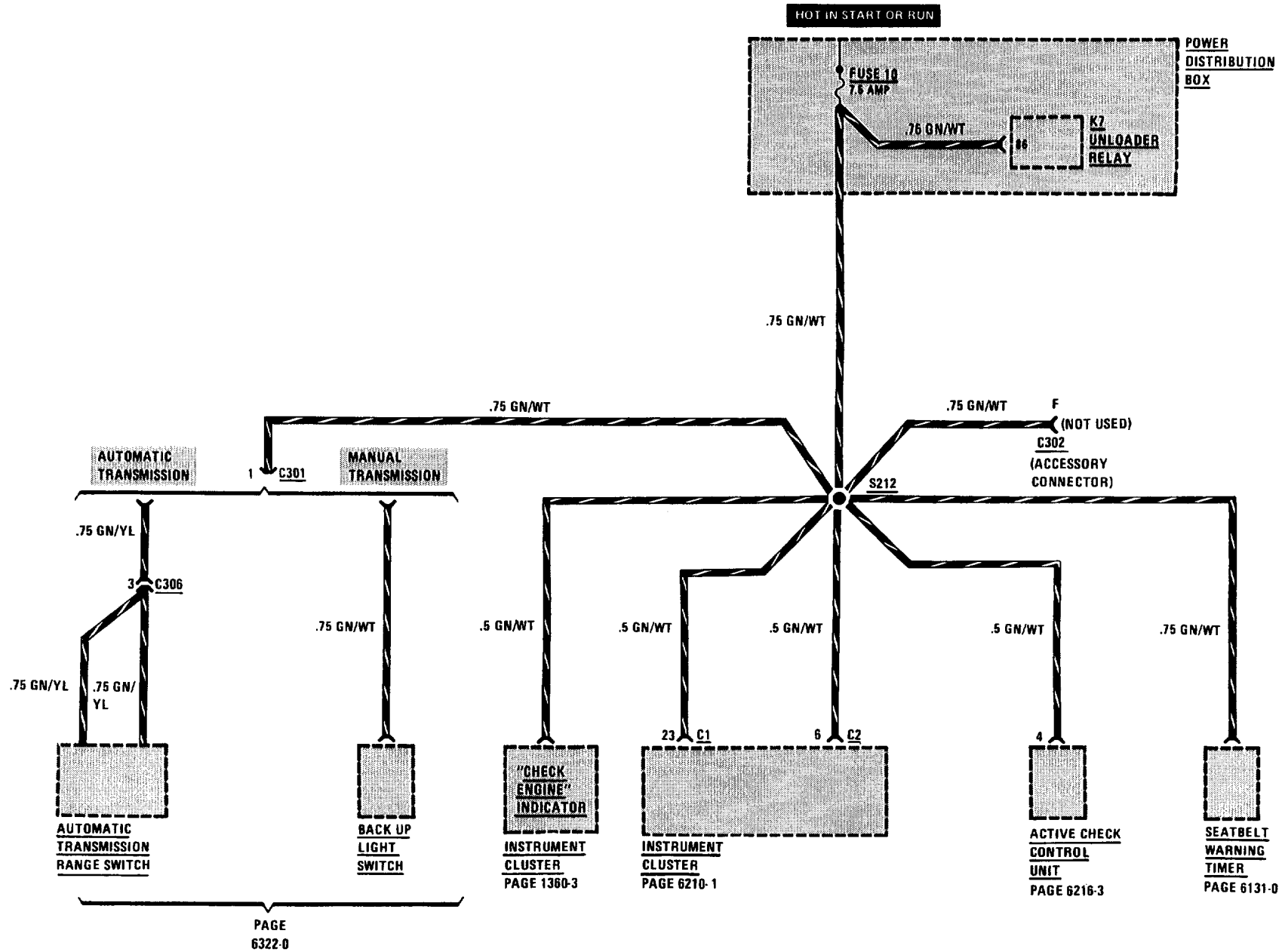

FUSE DETAILS: FUSE 20

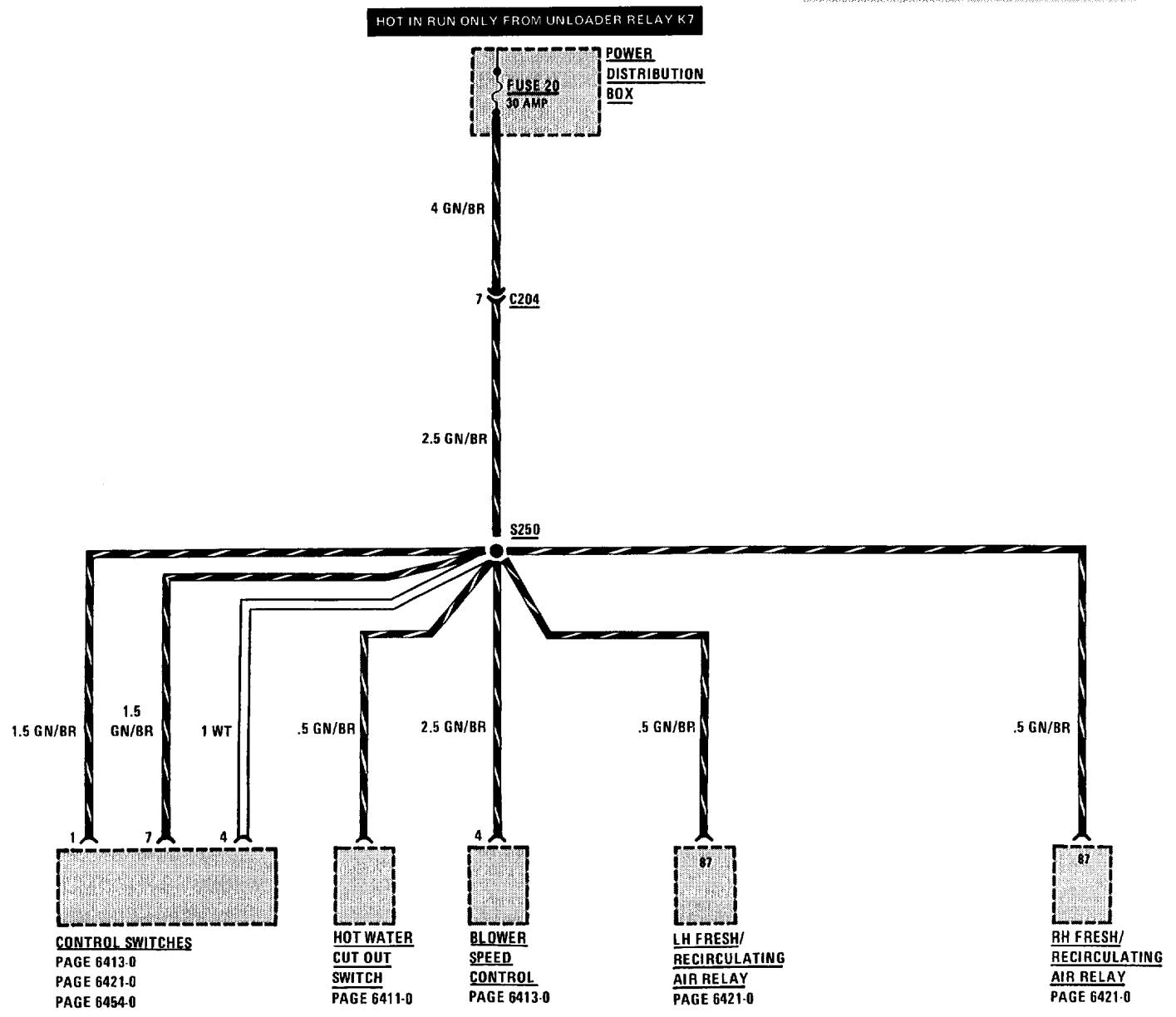

FUSE DETAILS: FUSE 21

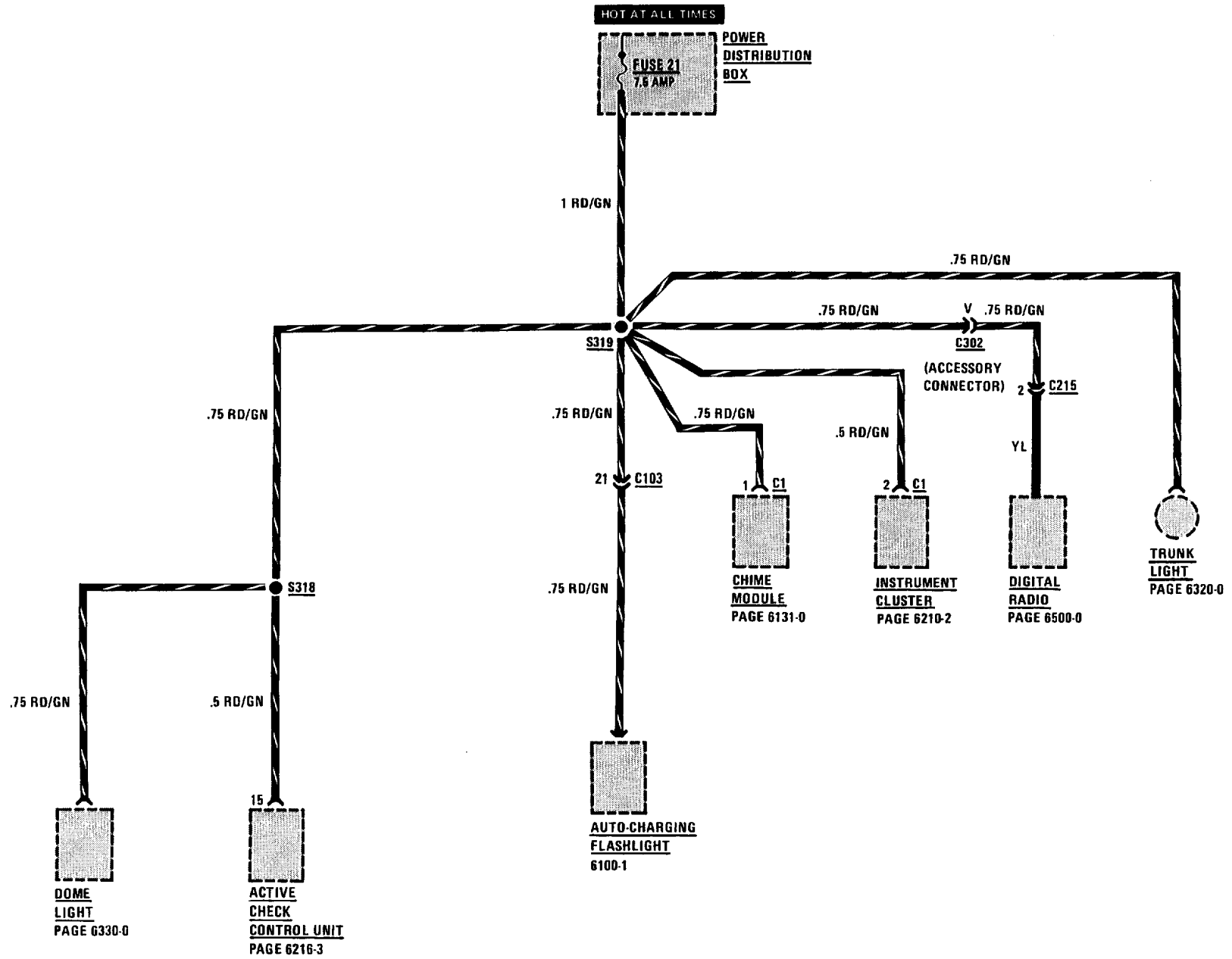

FUSE DETAILS: FUSES 9 AND 27

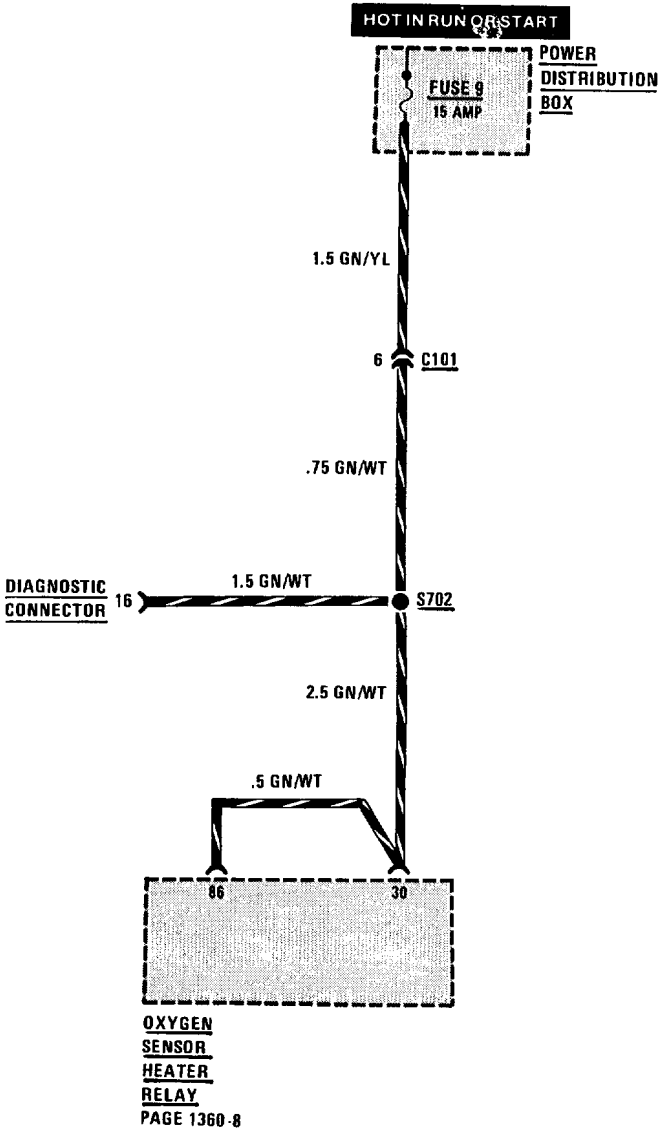
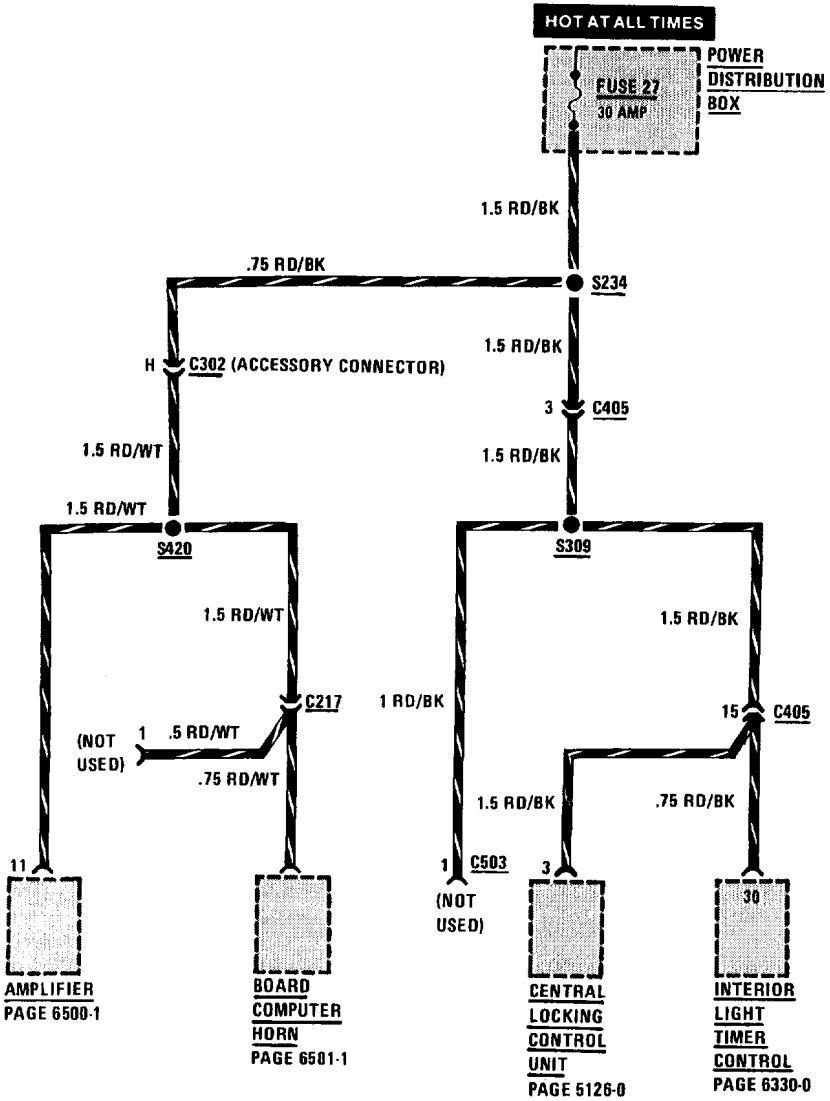

GROUND DISTRIBUTION: G103

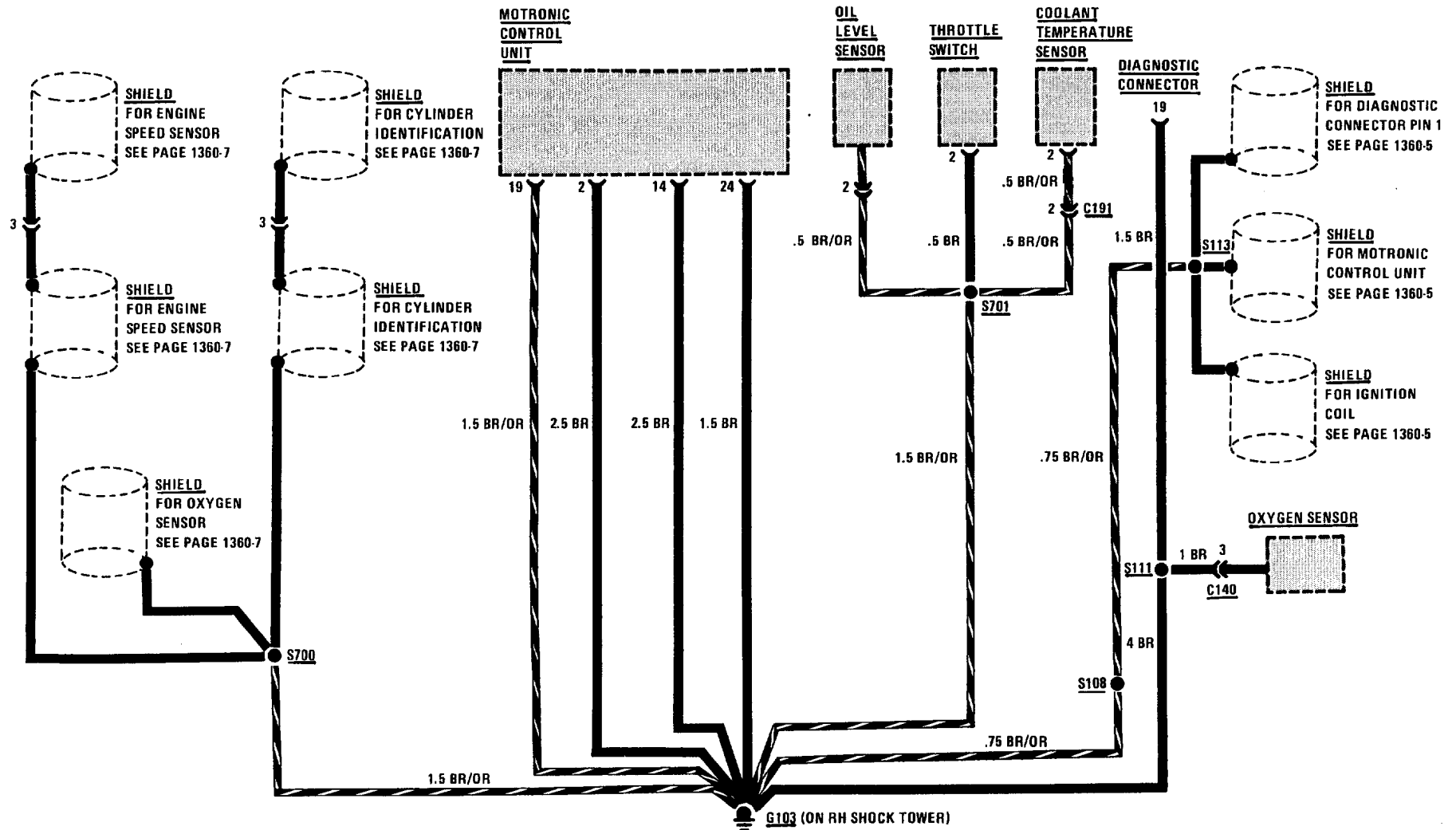

GROUND DISTRIBUTION: G104 AND G200 (PARTIAL)

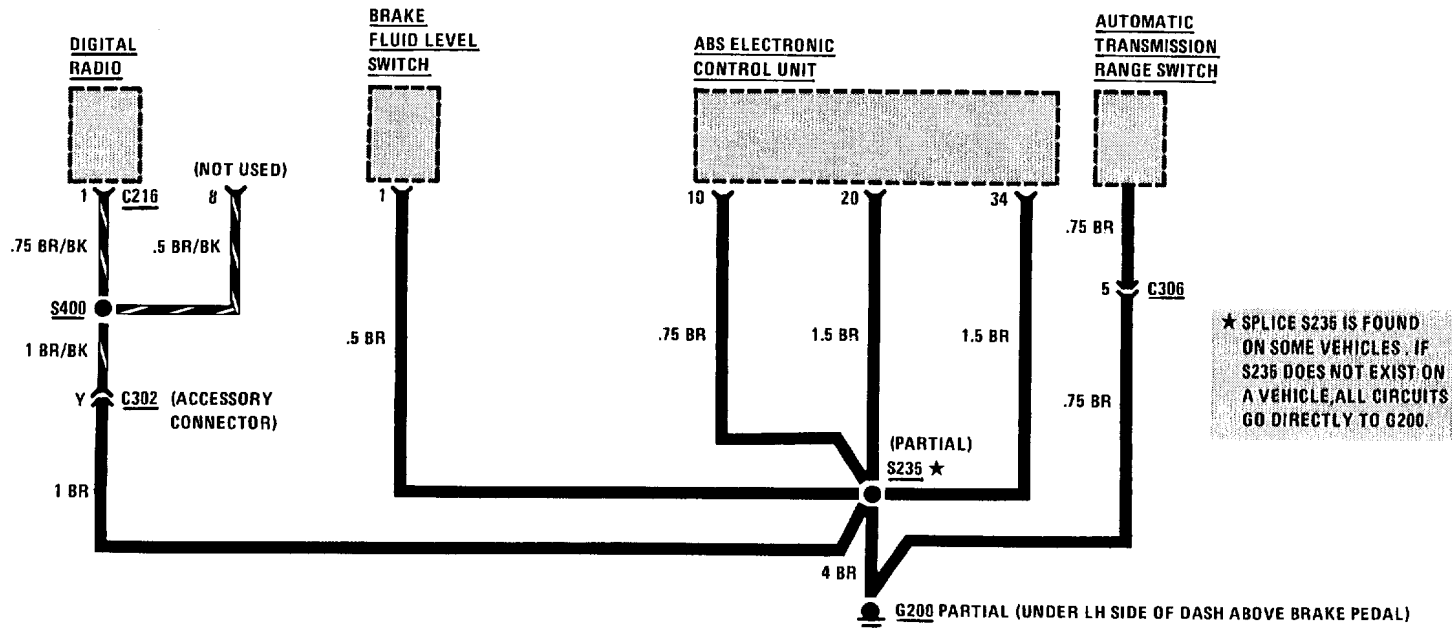
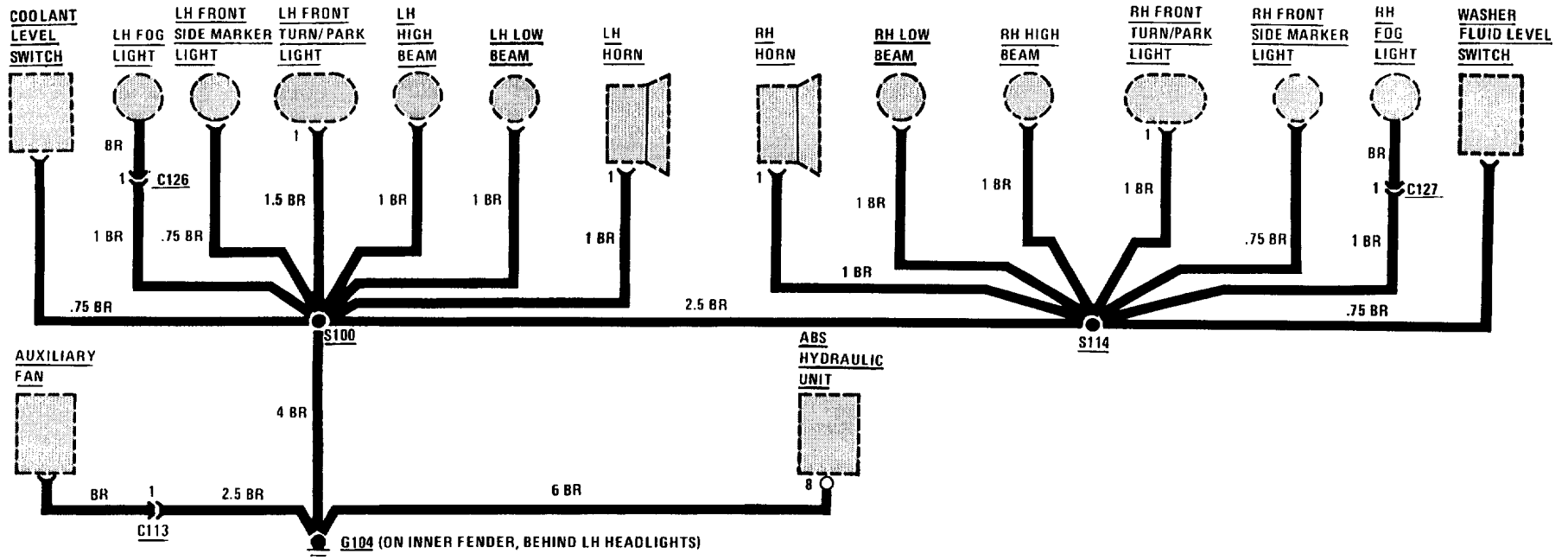

0670-14 POWER DISTRIBUTION

GROUND DISTRIBUTION: G200 (PARTIAL) AND G201

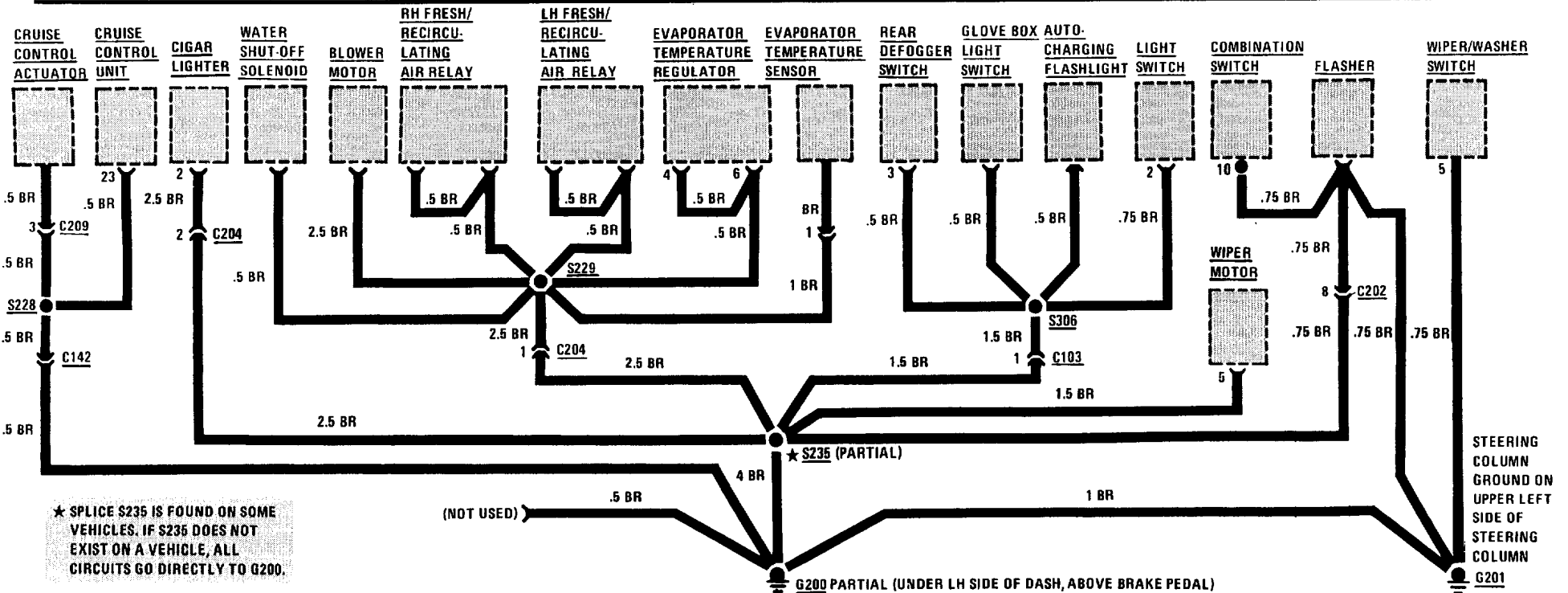
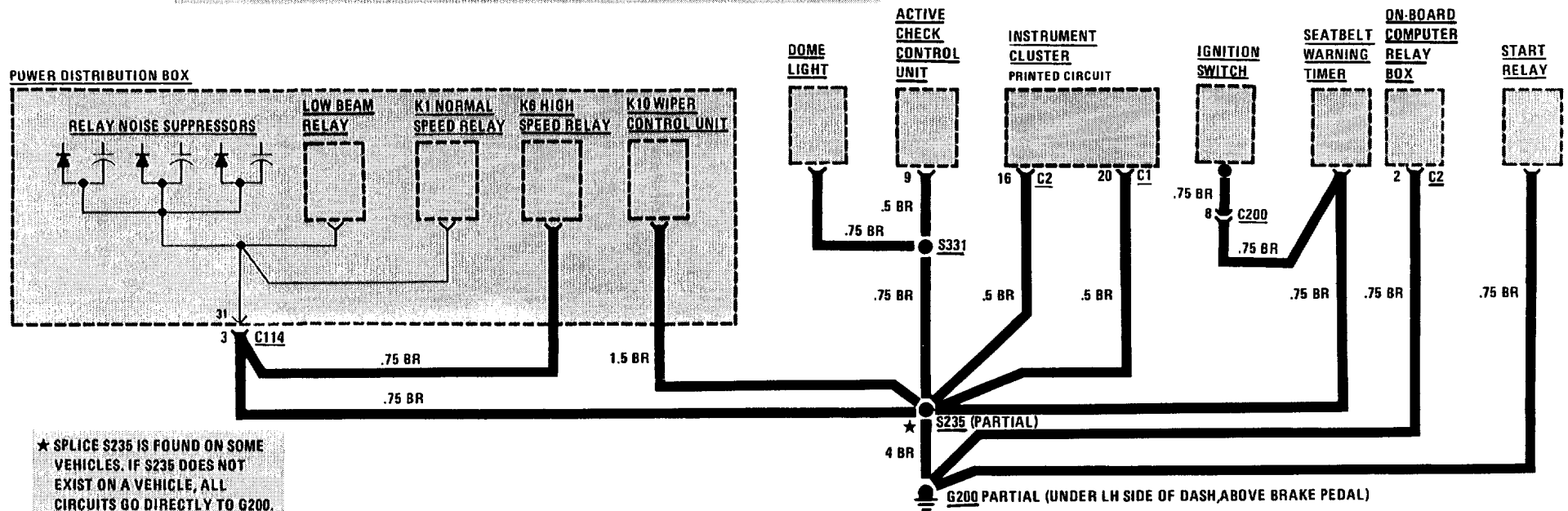

GROUND DISTRIBUTION: G200 (PARTIAL) AND G202 (PARTIAL) (G203)

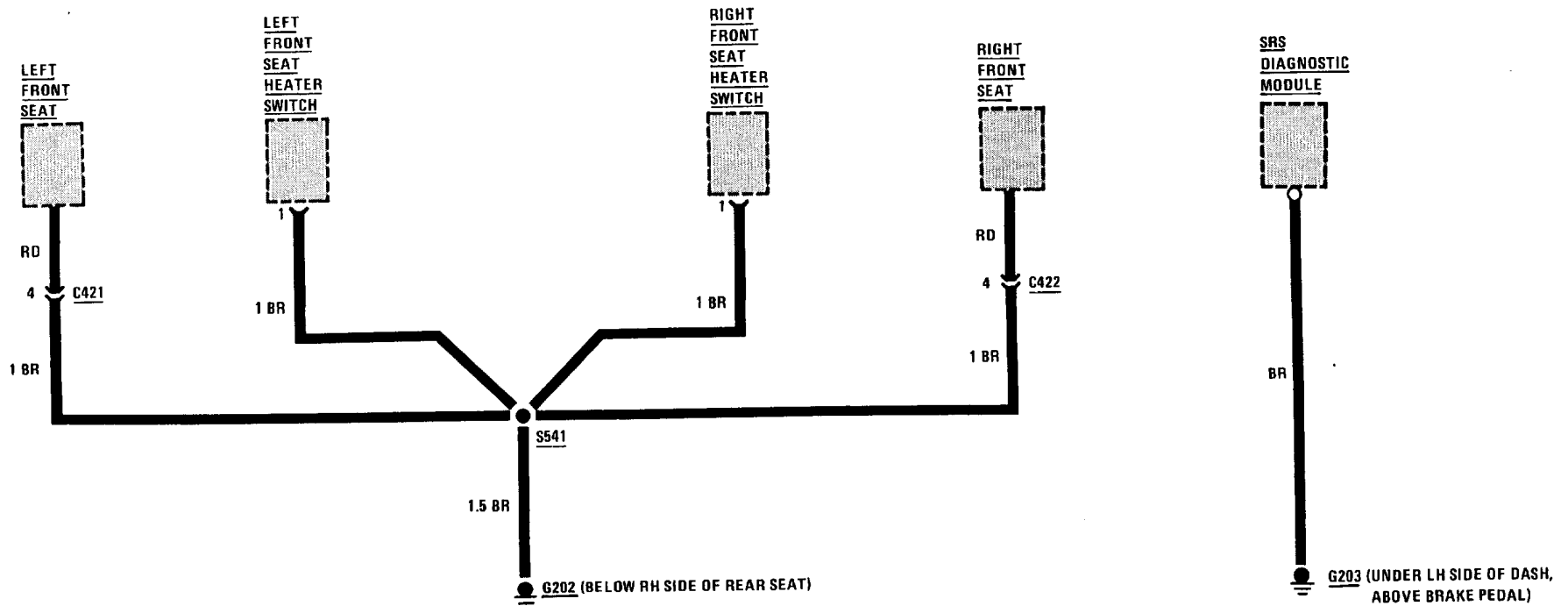
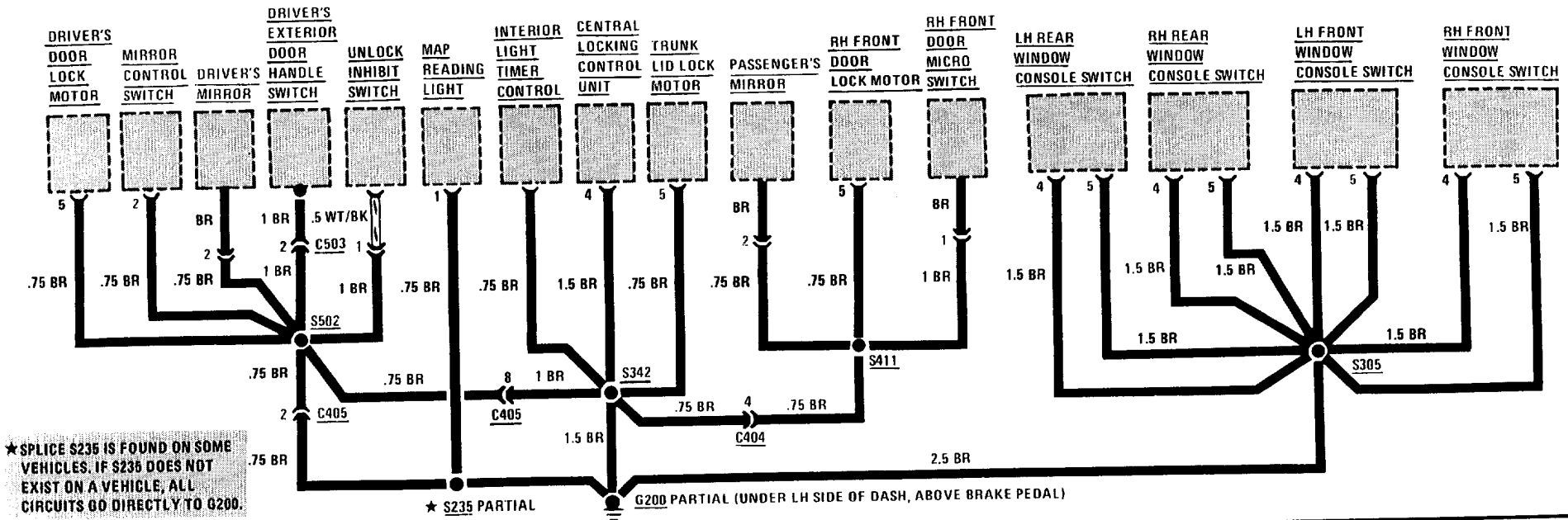

0670-16 POWER DISTRIBUTION

GROUND DISTRIBUTION: G202 AND G300

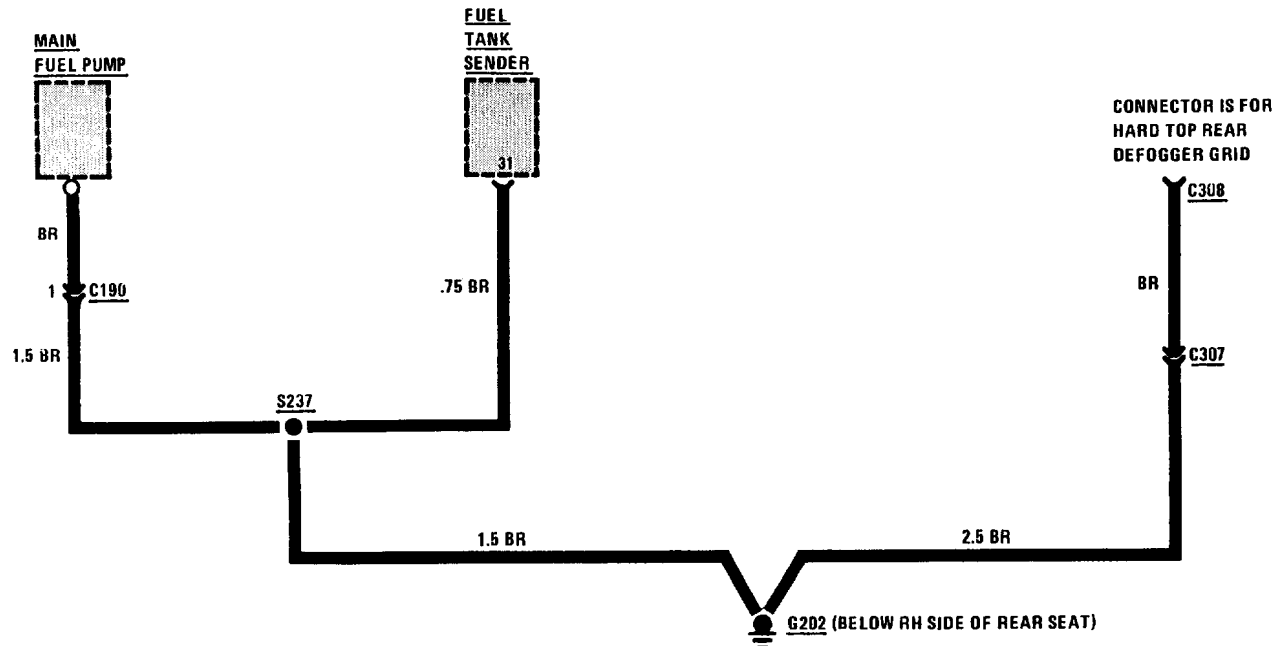
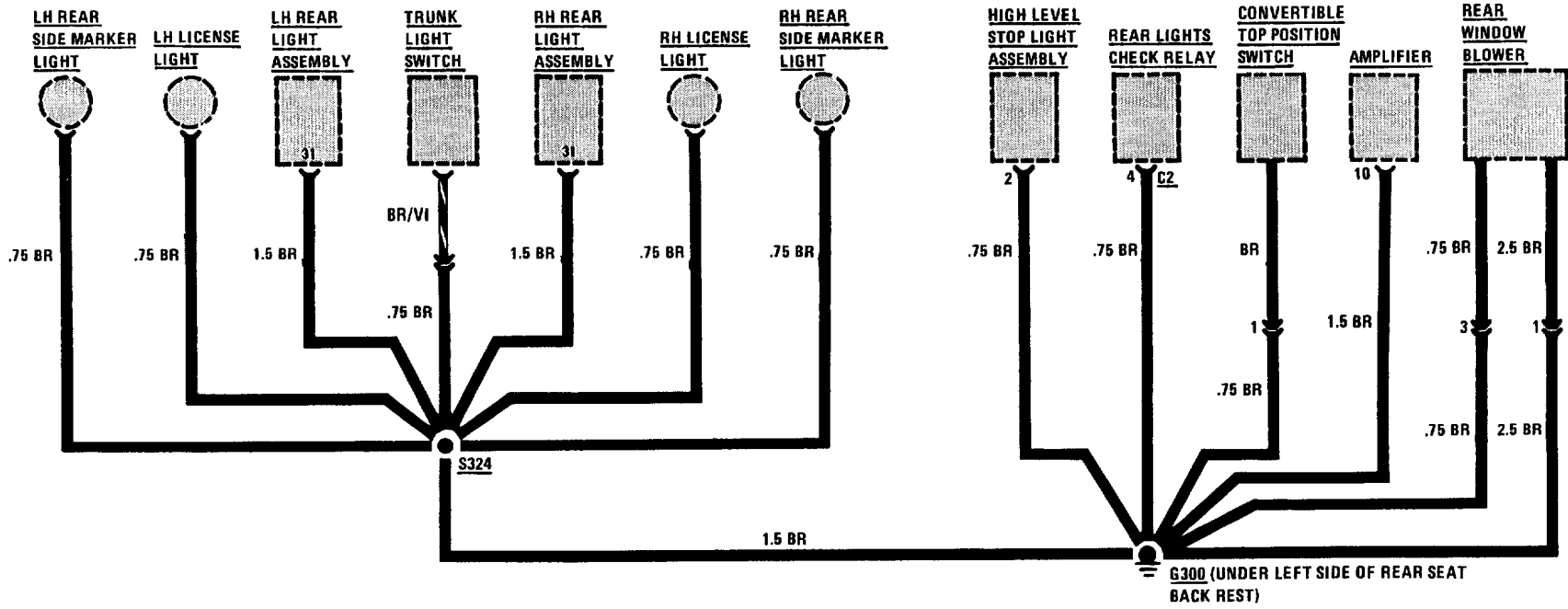

GROUND DISTRIBUTION: G303 AND G304

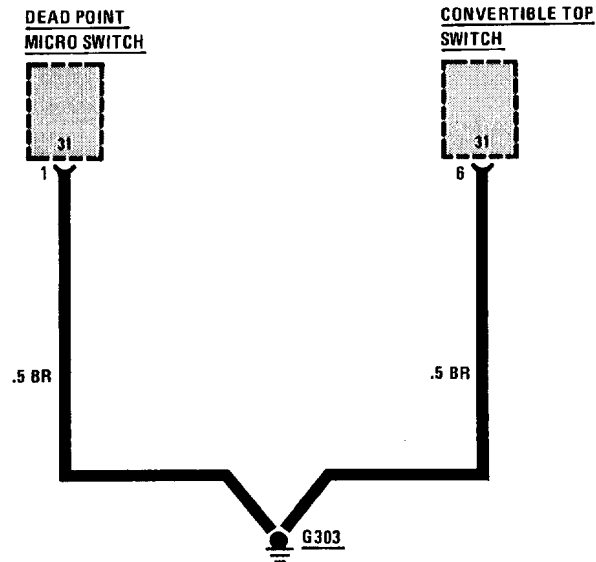
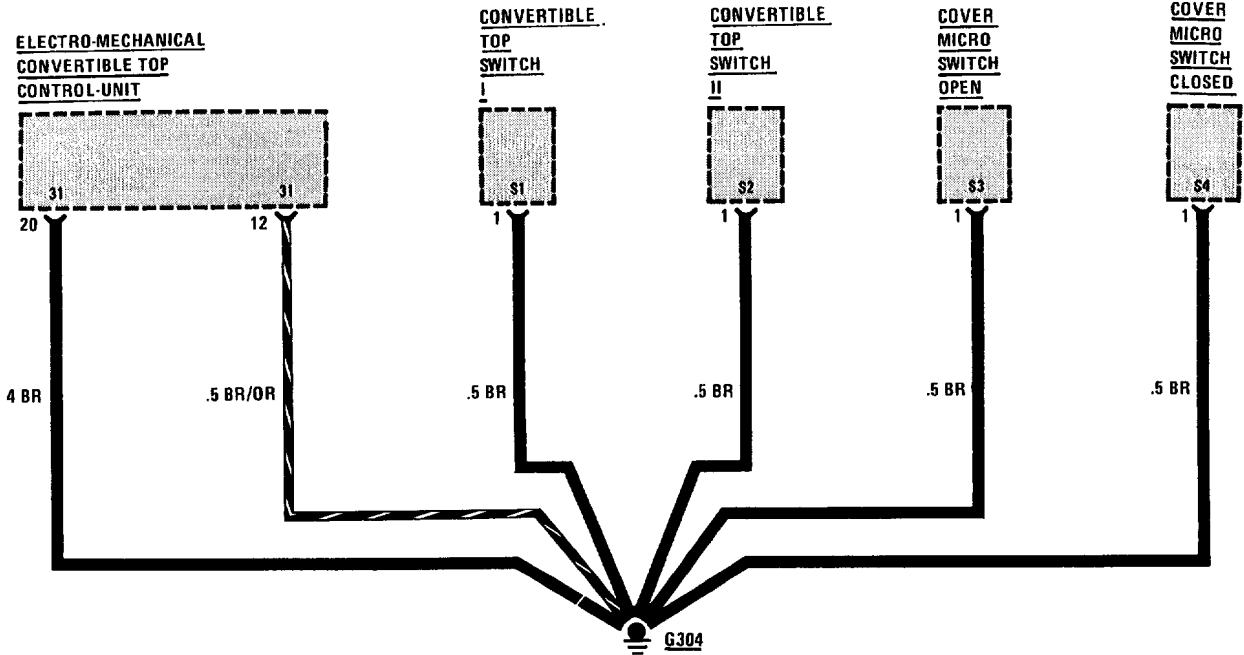

1230-0 CHARGE

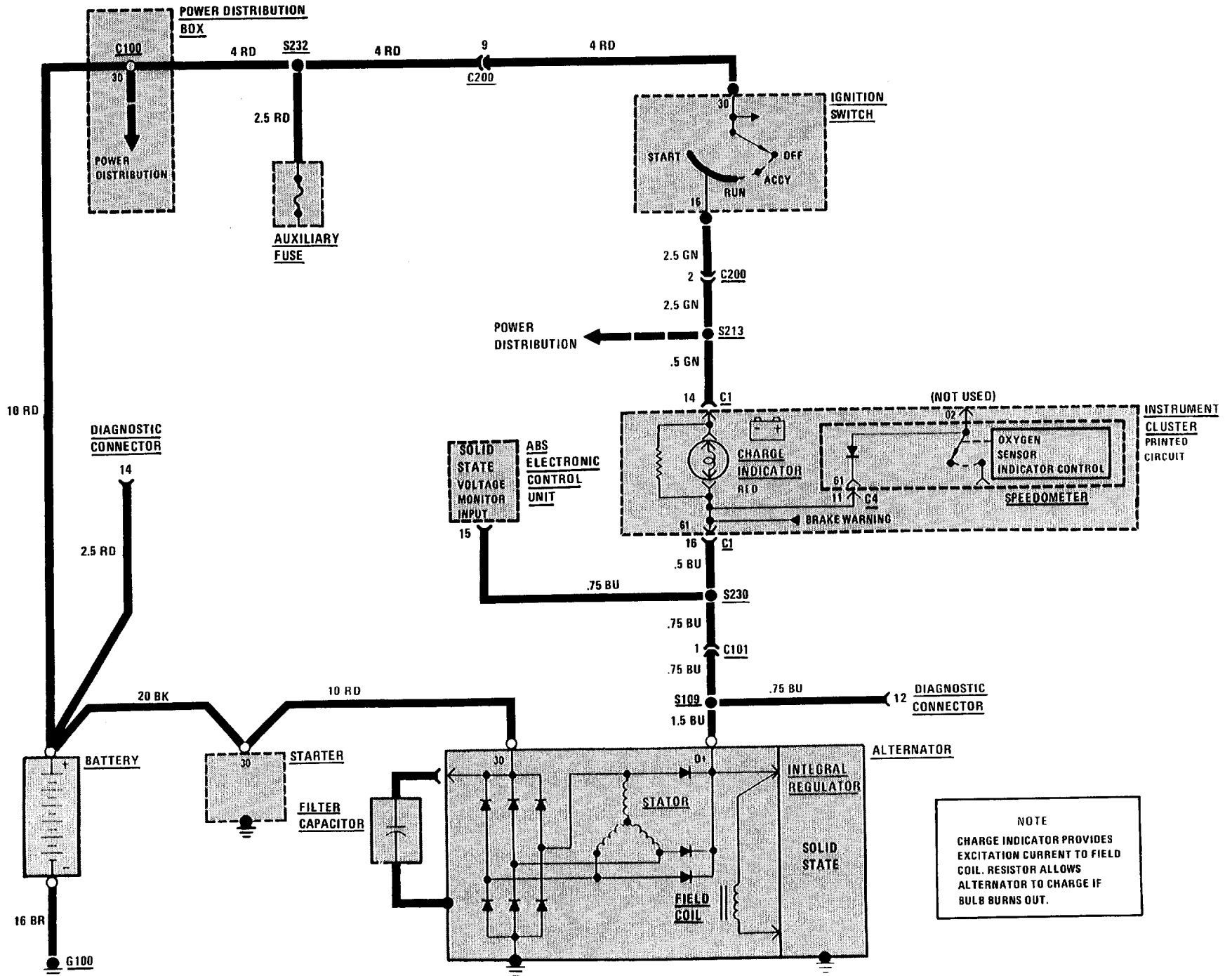

AUTOMATIC TRANSMISSION

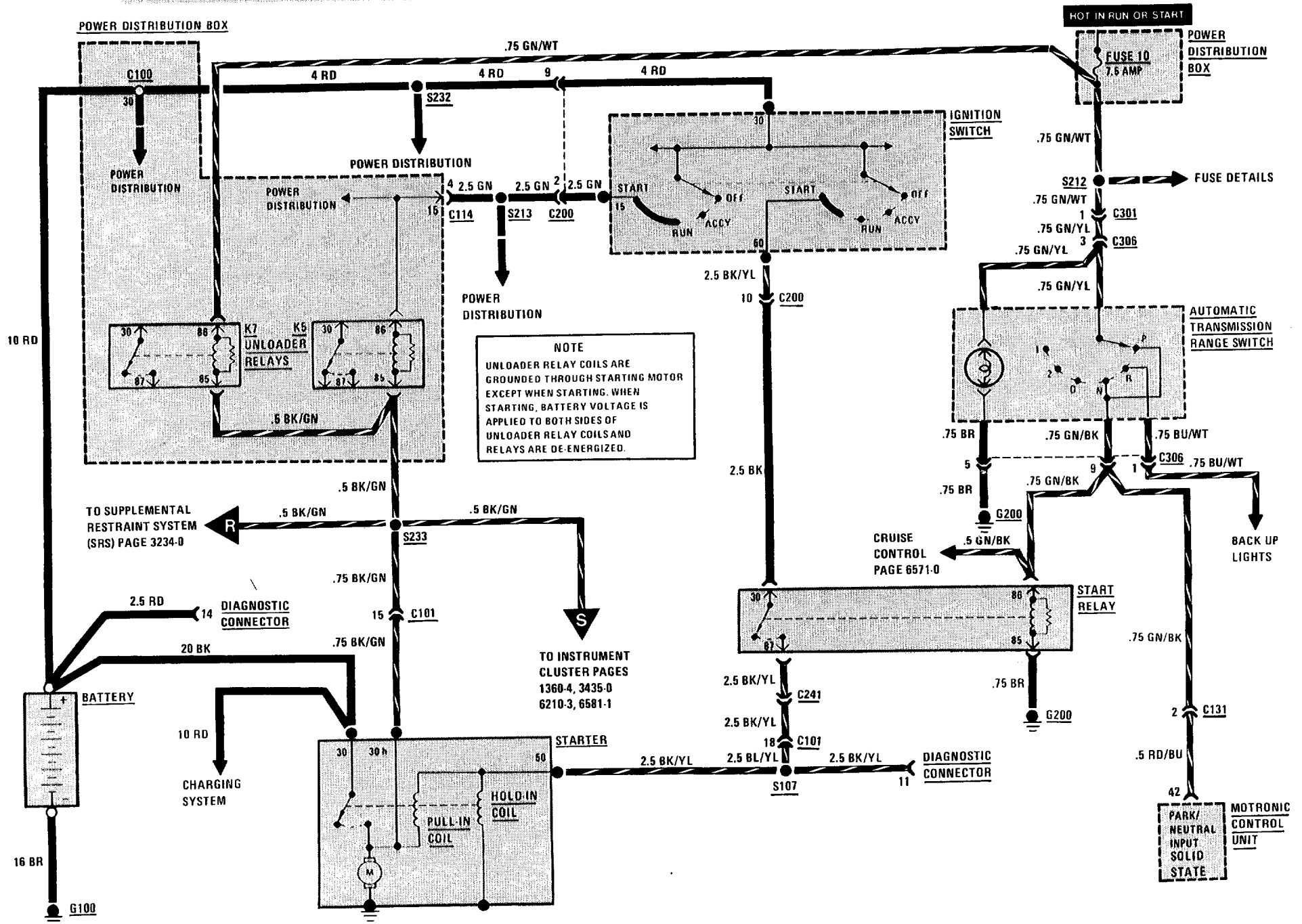

NOTE
UNLOADER RELAY COILS ARE GROUNDED THROUGH STARTING MOTOR EXCEPT WHEN STARTING. WHEN STARTING, BATTERY VOLTAGE IS APPLIED TO BOTH SIDES OF UNLOADER RELAY COILS AND RELAYS ARE DE-ENERGIZED.

MANUAL TRANSMISSION

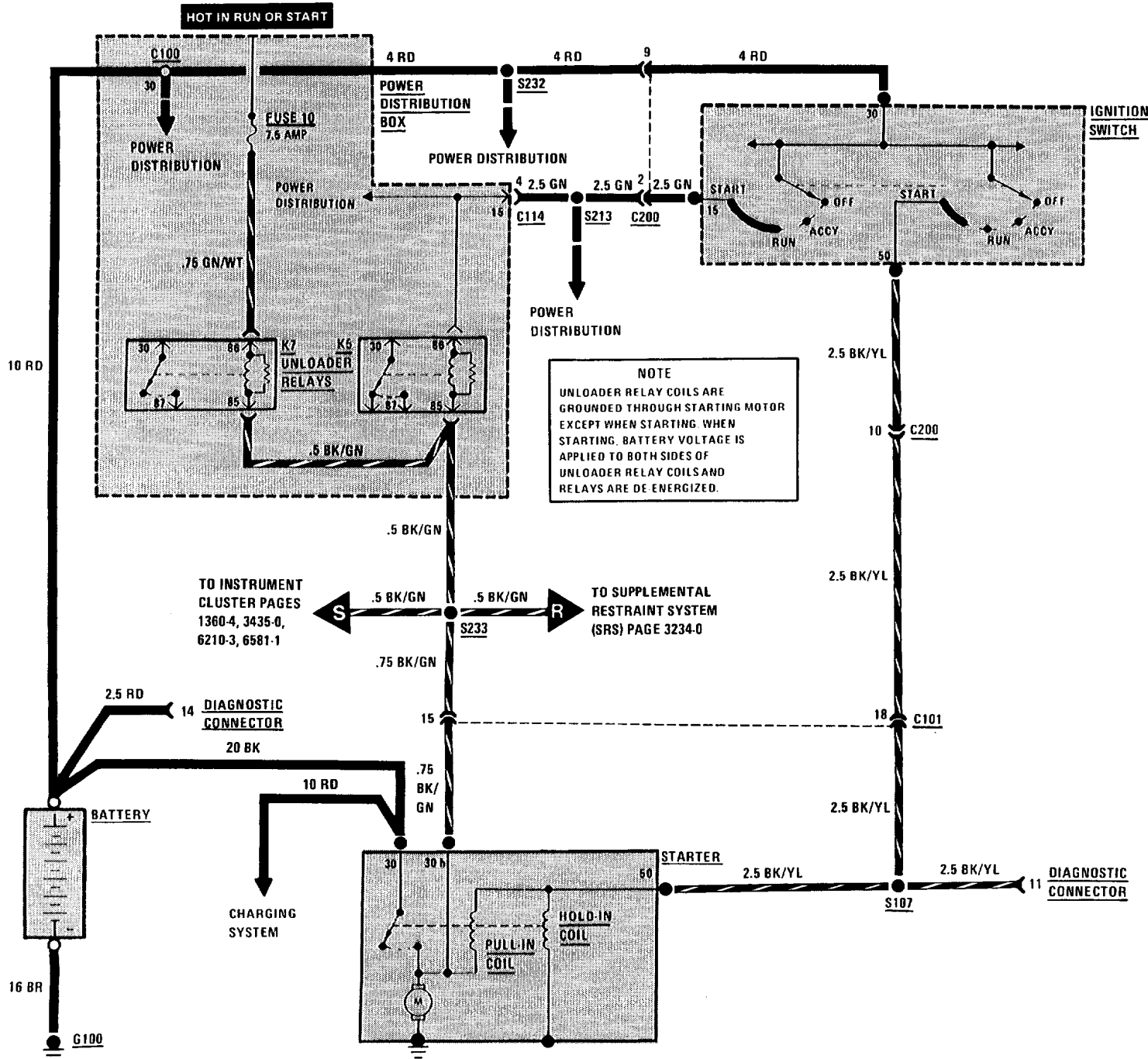

1360-0 INJECTION ELECTRONICS

ENGINE BLOCK DIAGRAM

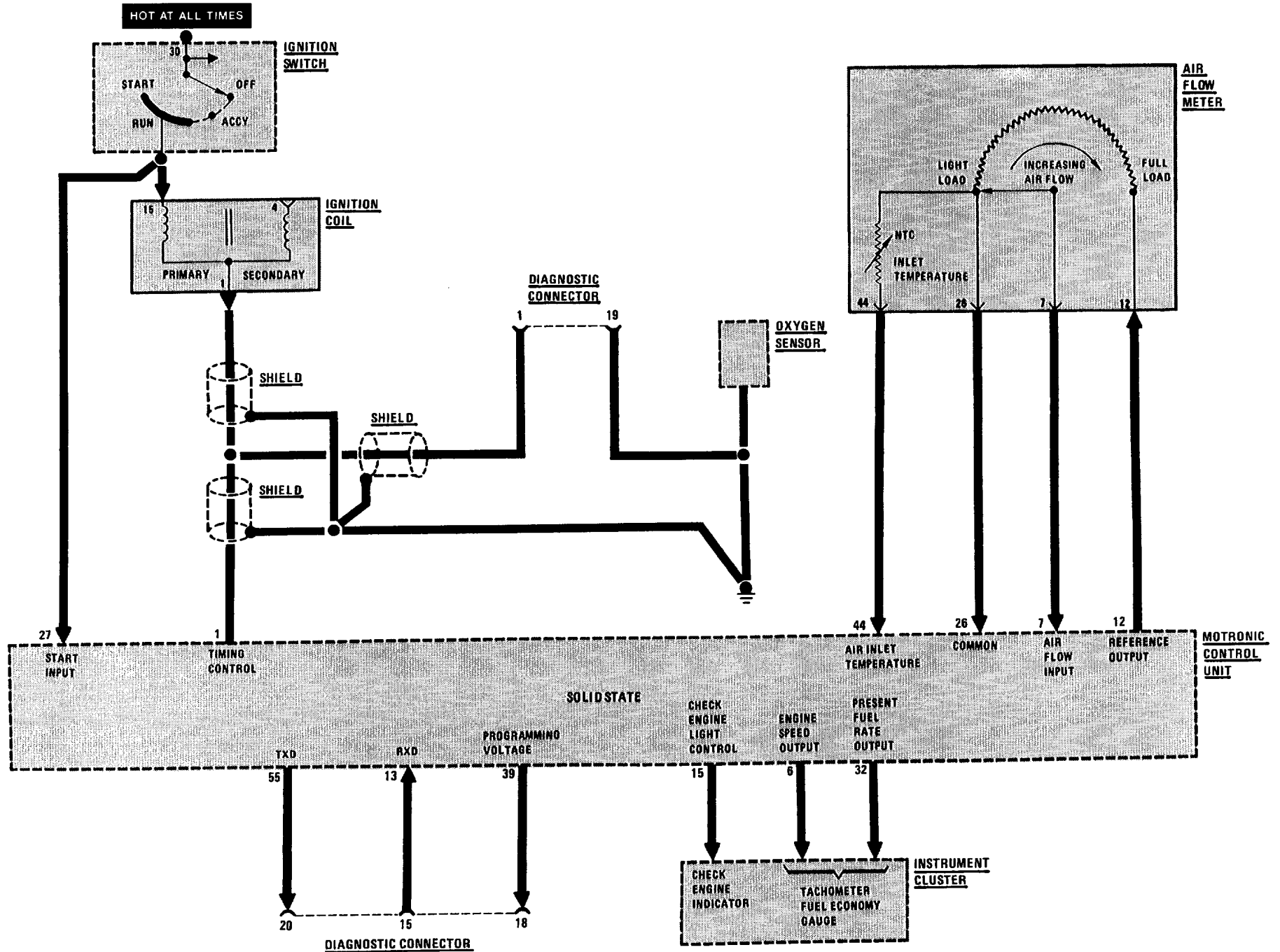

ENGINE BLOCK DIAGRAM

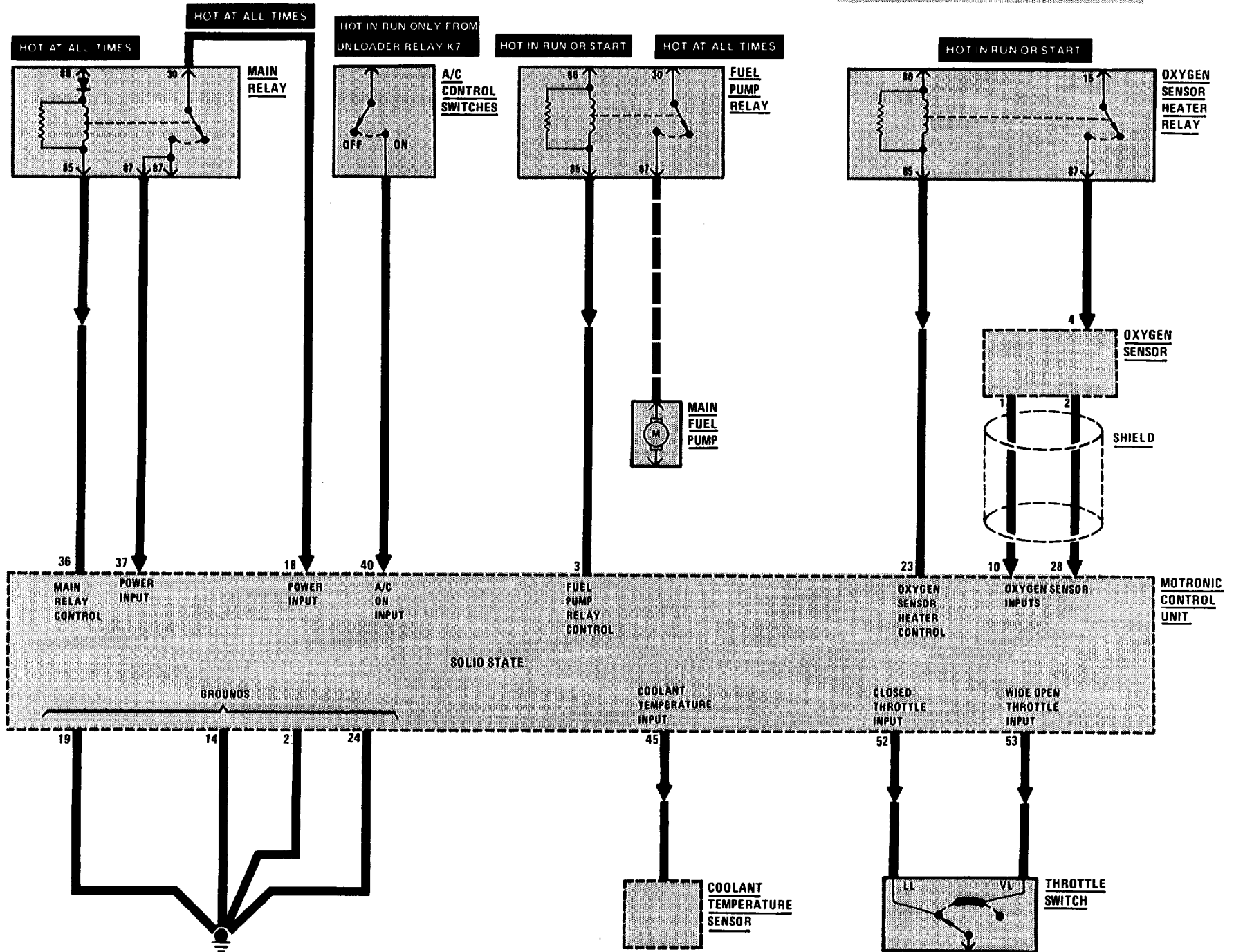

1360-2 INJECTION ELECTRONICS

ENGINE BLOCK DIAGRAM

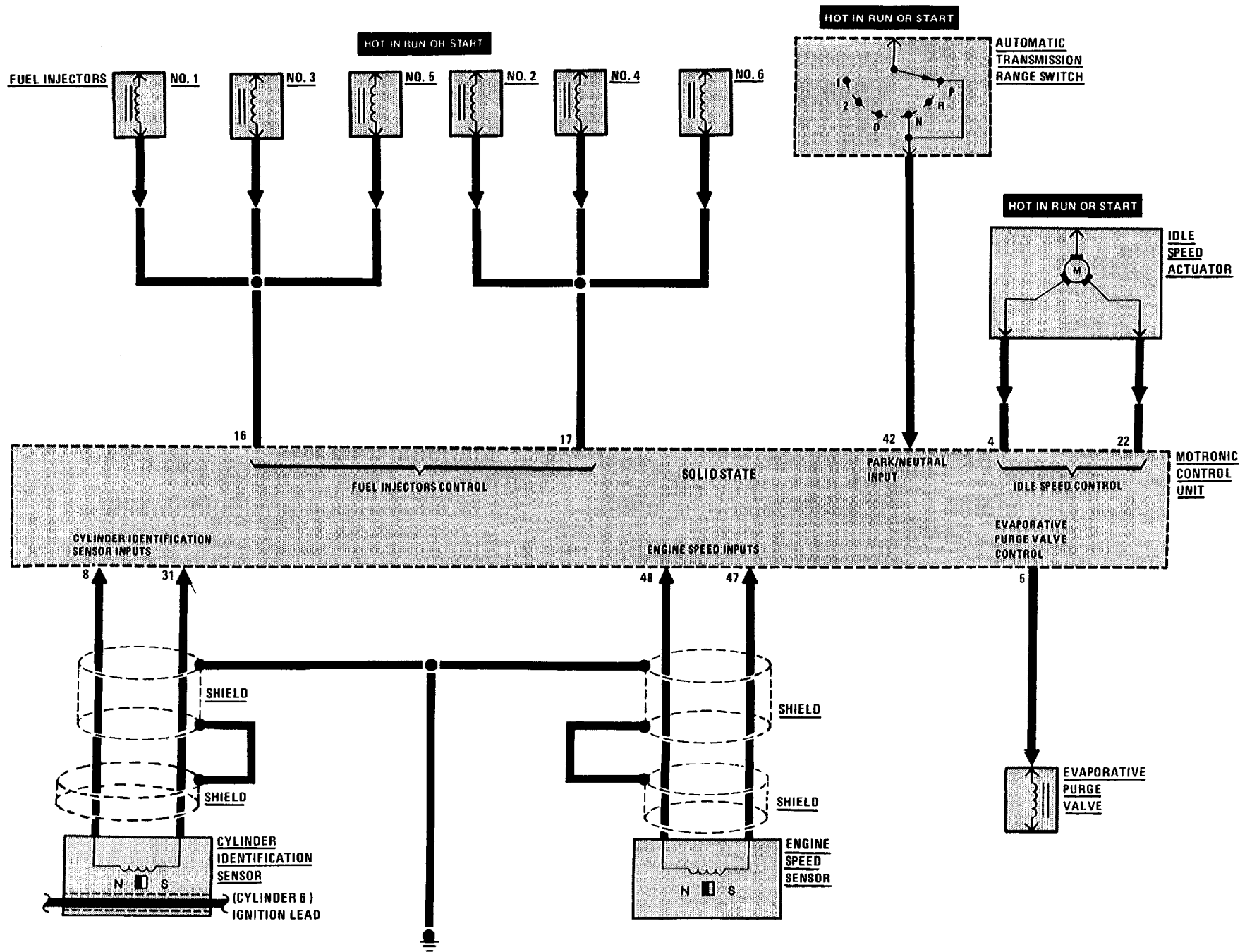

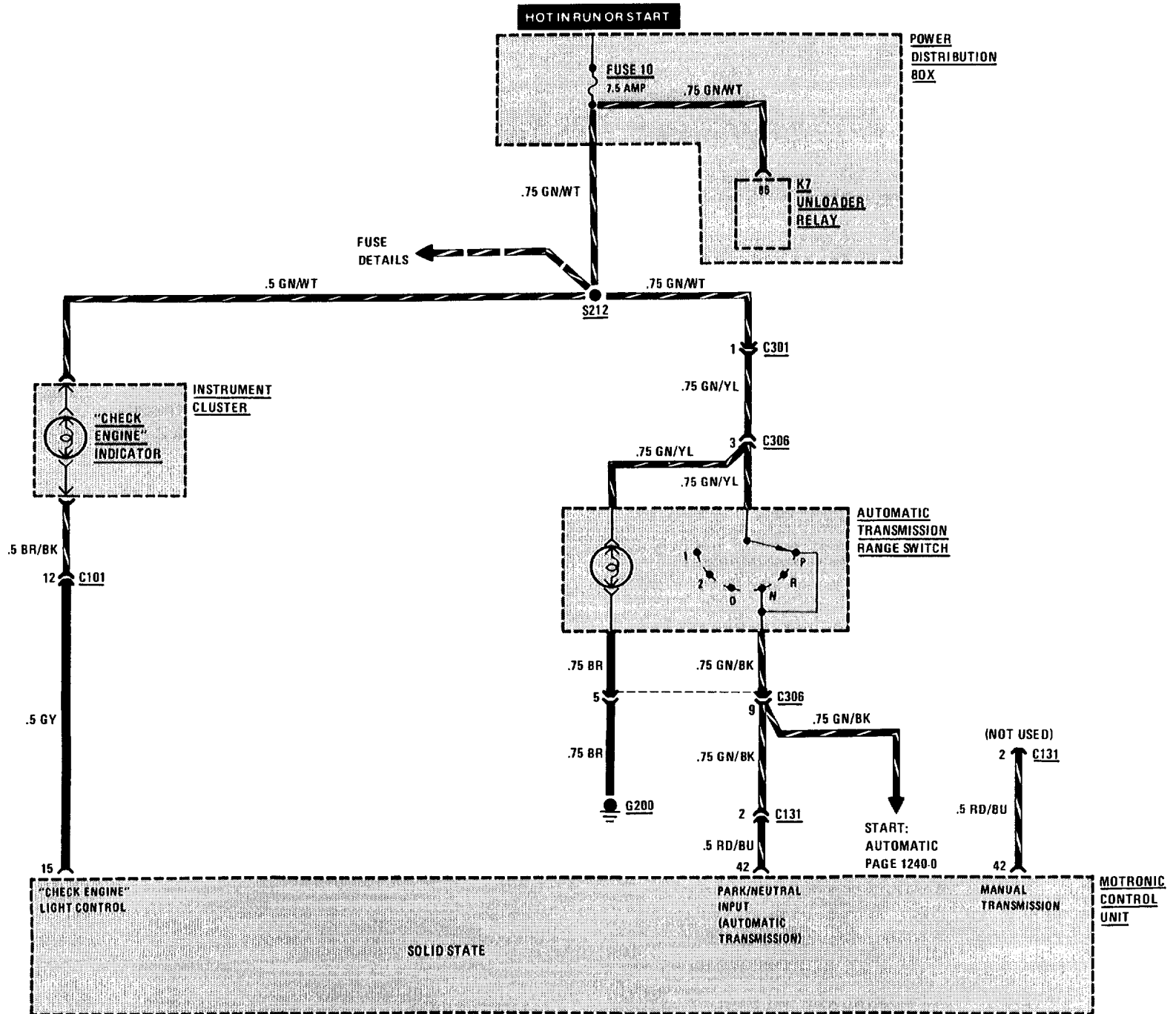

1360-4 INJECTION ELECTRONICS

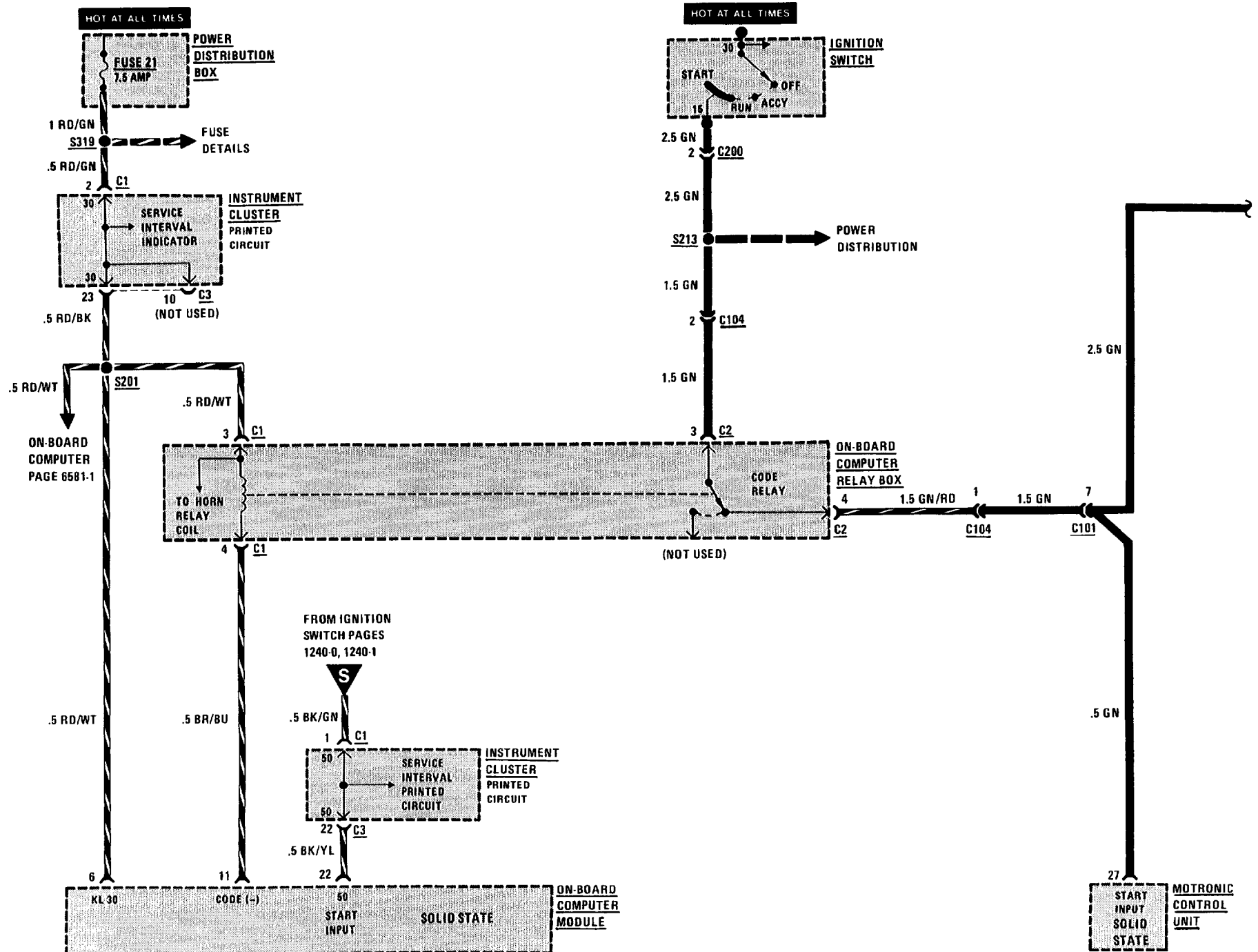

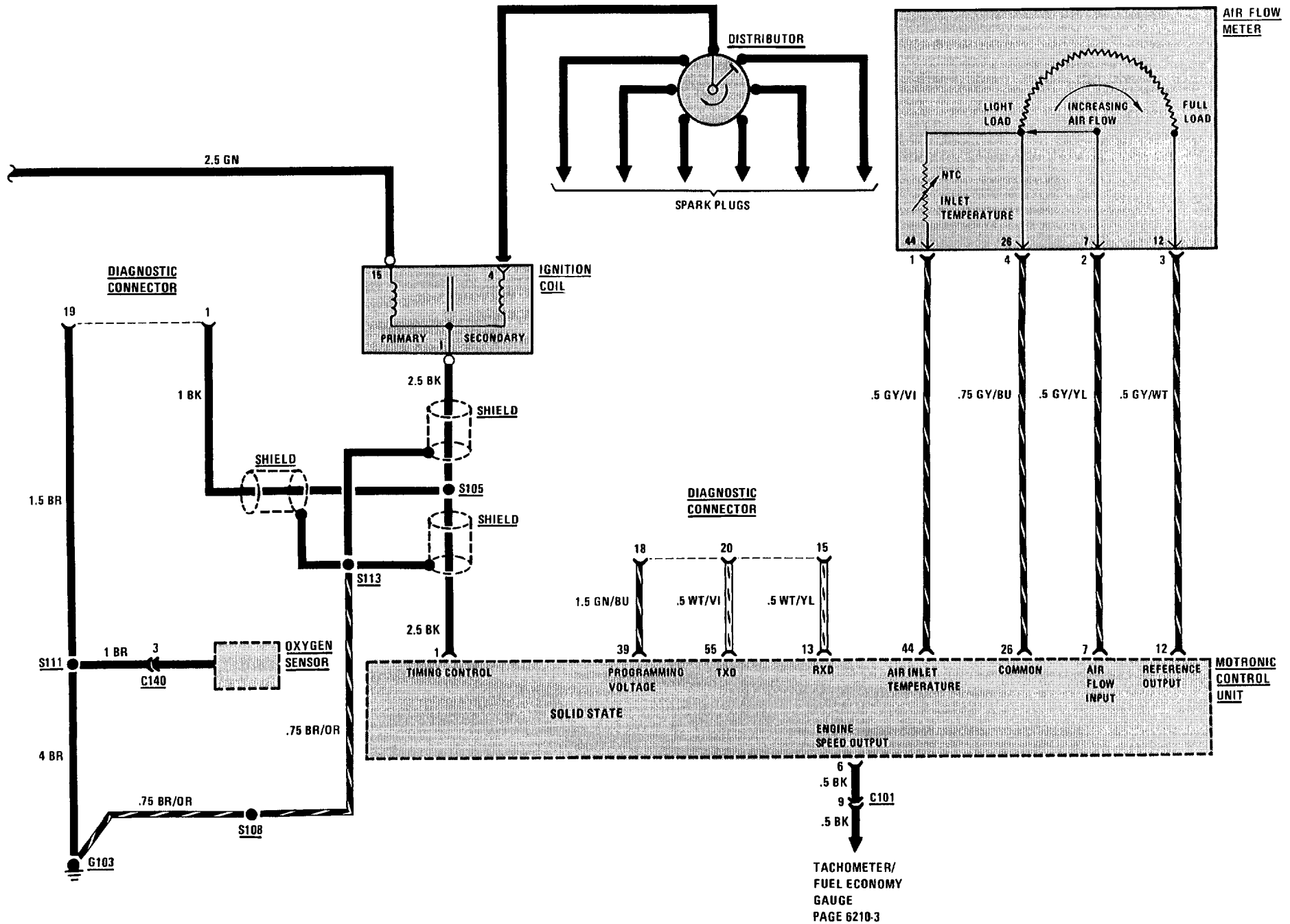

1360-6 INJECTION ELECTRONICS

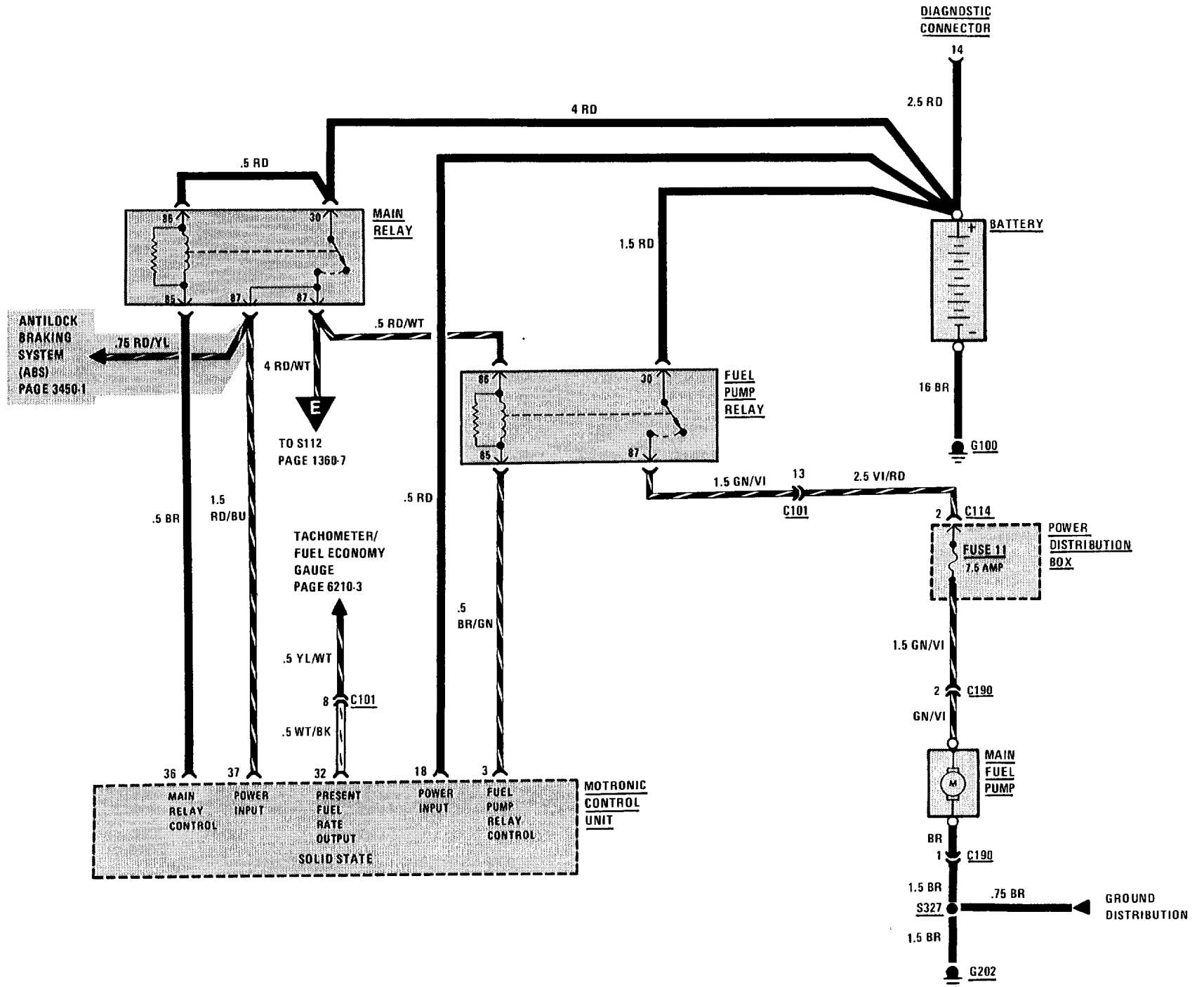

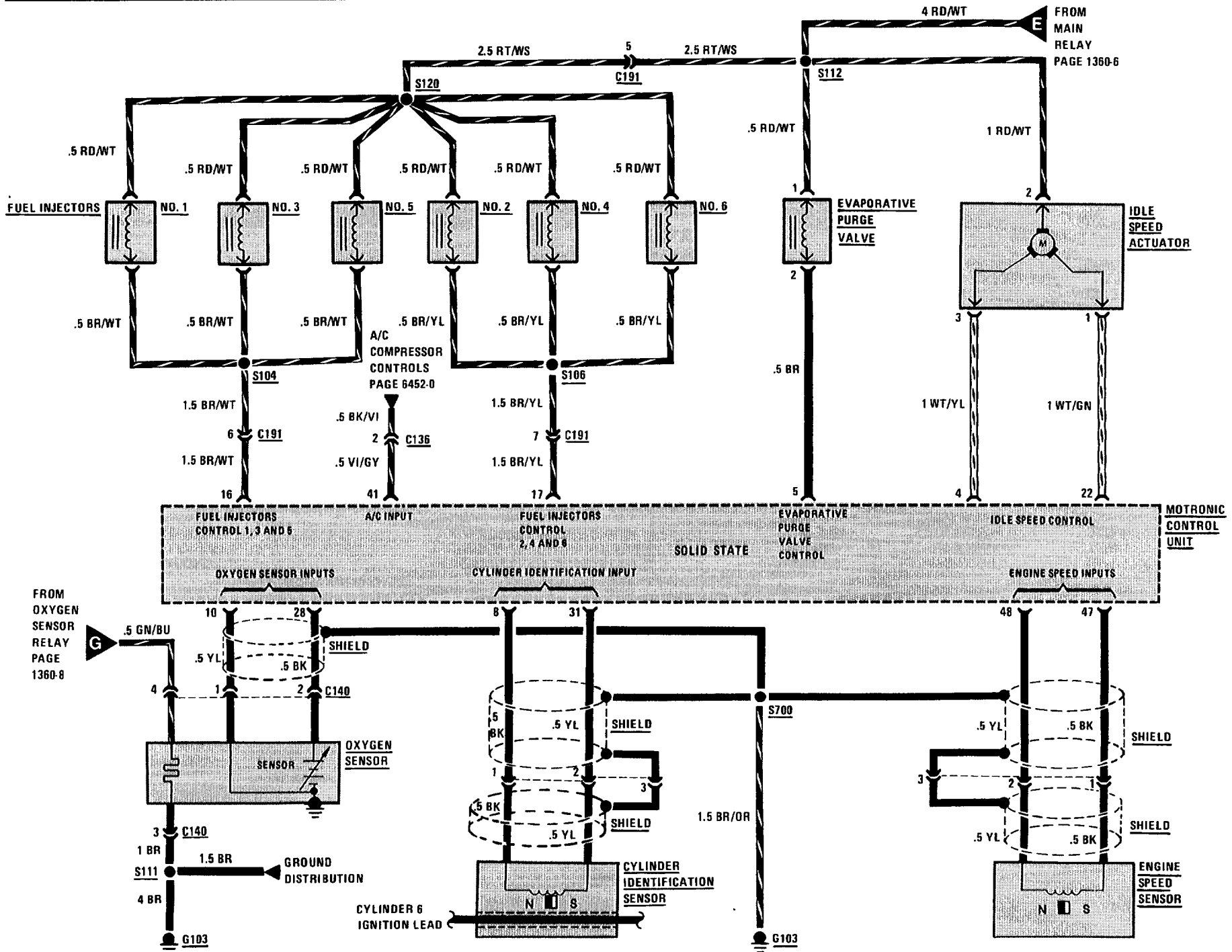

FROM OXYGEN SENSOR RELAY PAGE 1360-8

FROM MAIN RELAY PAGE 1360-6

A/C COMPRESSOR CONTROLS PAGE 6452-0

MOTRONIC CONTROL UNIT

GROUND DISTRIBUTION

CYLINDER IDENTIFICATION SENSOR

ENGINE SPEED SENSOR

1360-8 INJECTION ELECTRONICS

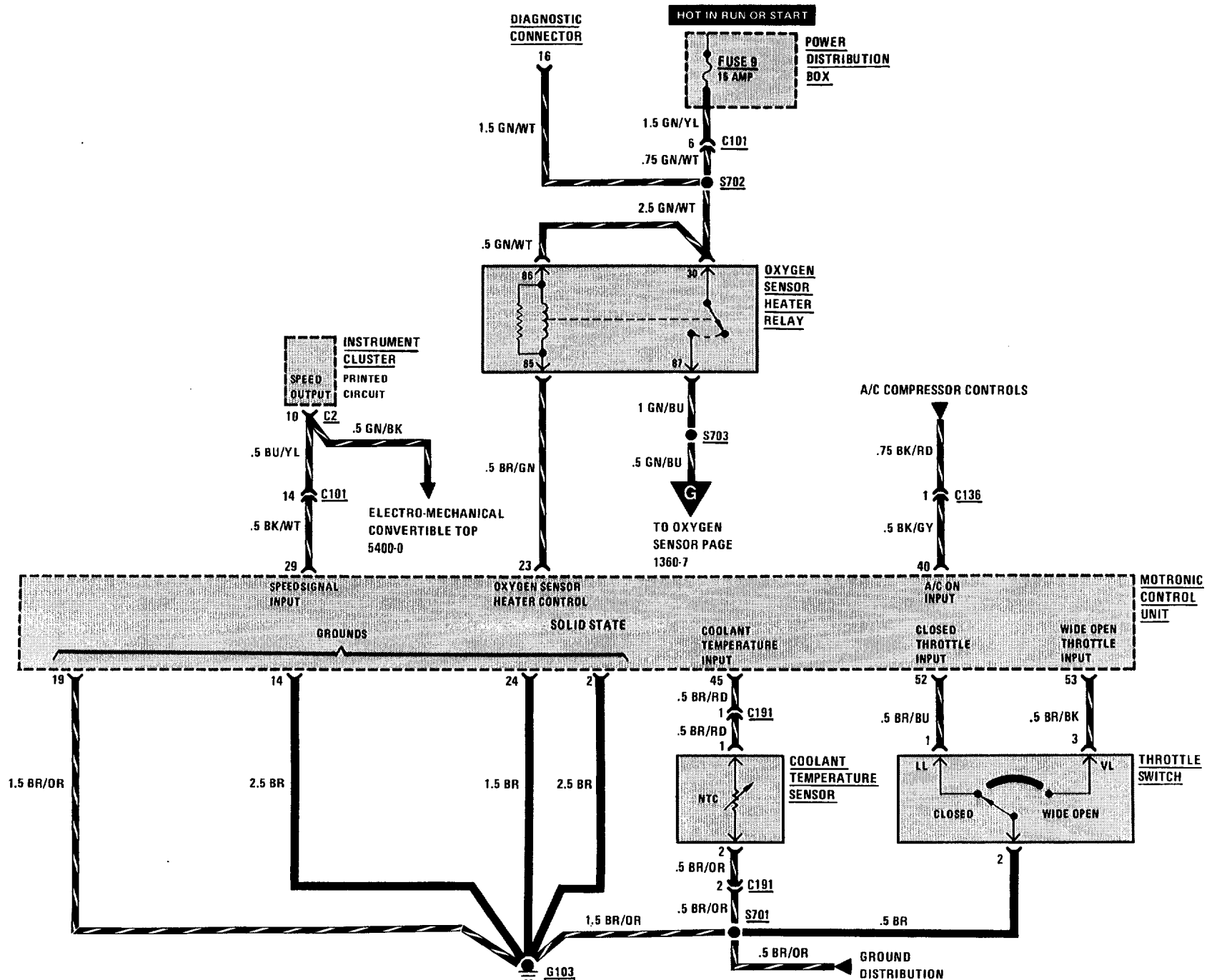

3234-0 SUPPLEMENTAL RESTRAINT SYSTEM (SRS)

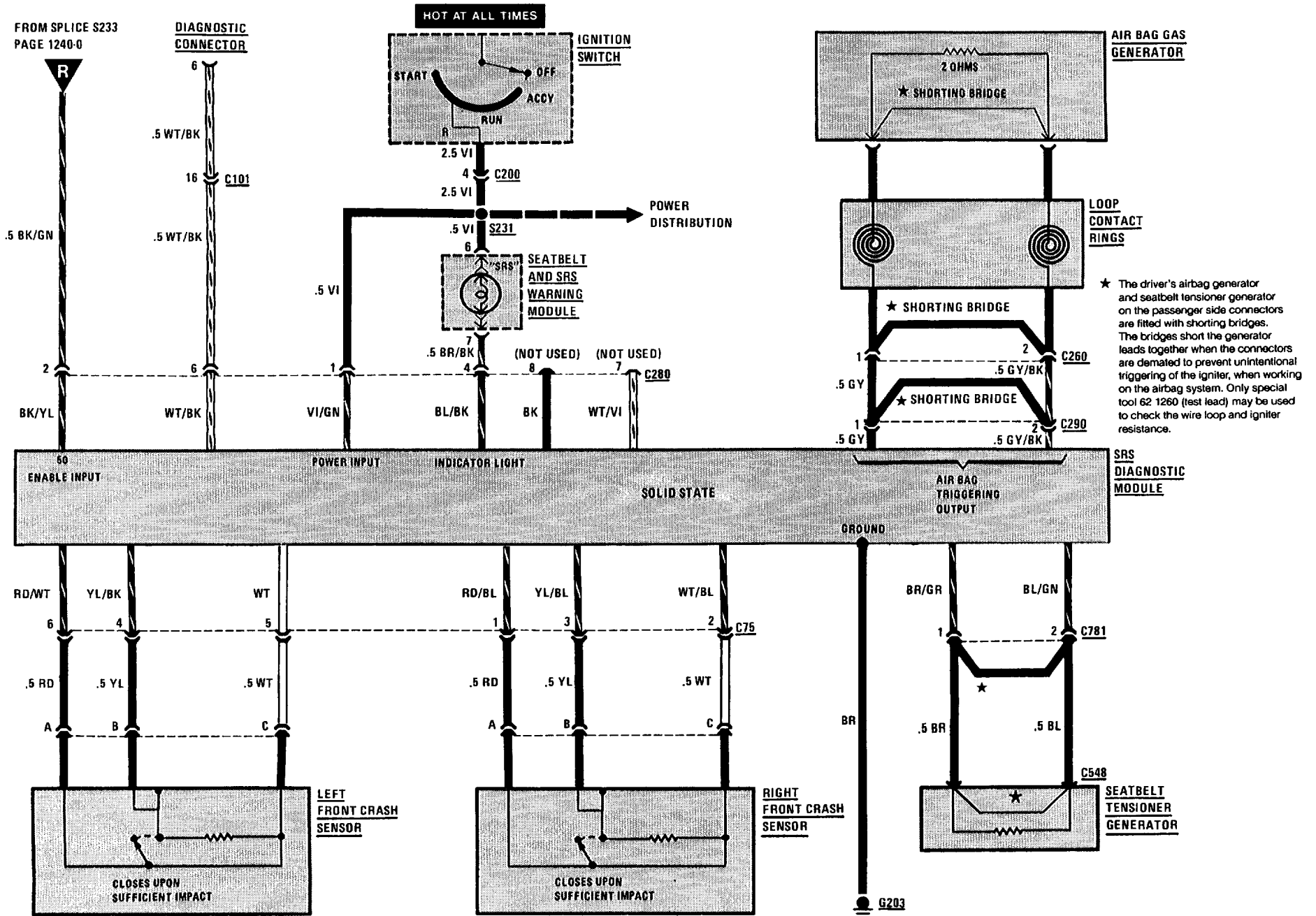

3435-0 BRAKE WARNING SYSTEM

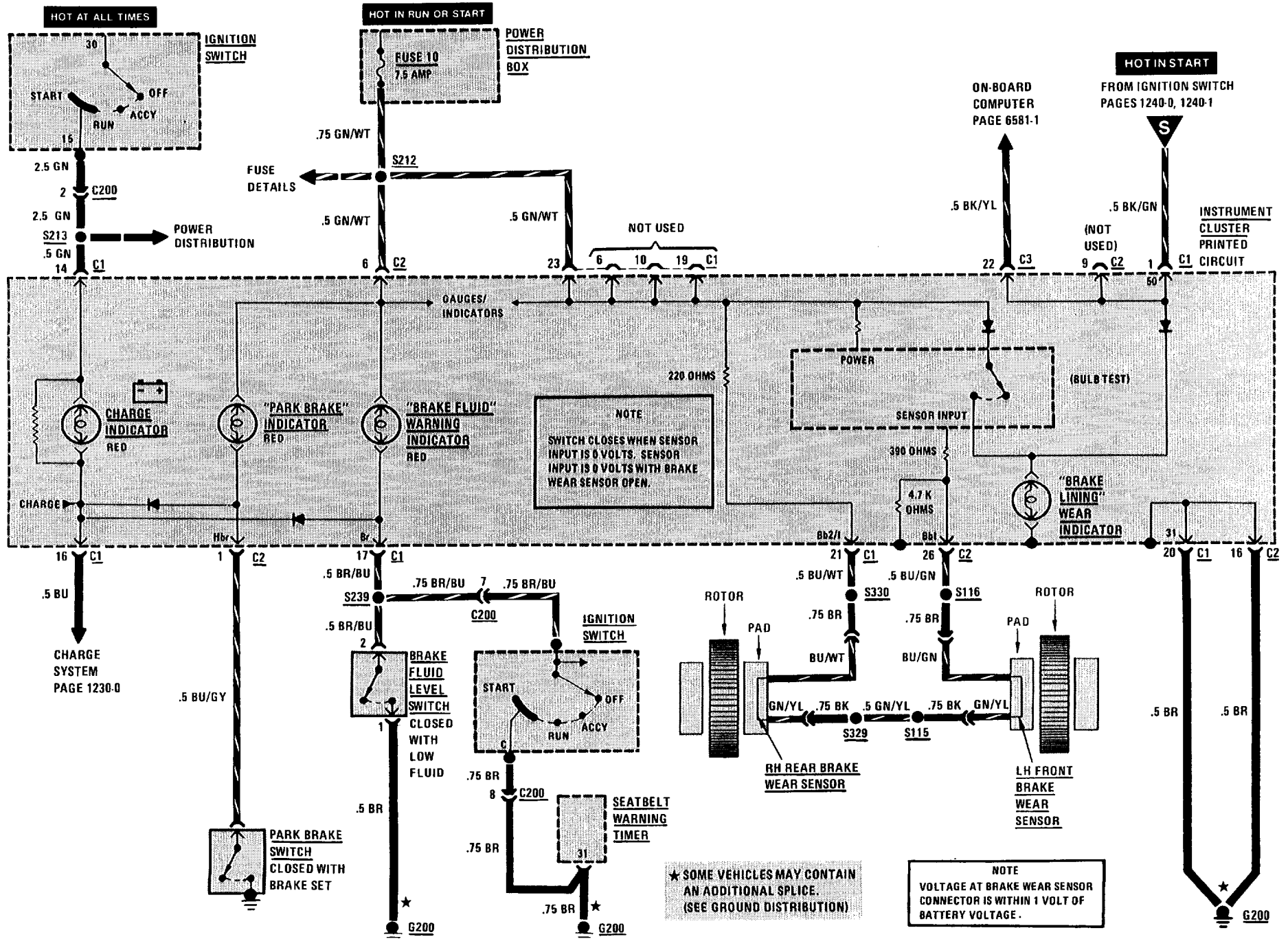

3450-0 ANTILOCK BRAKING SYSTEM (ABS)

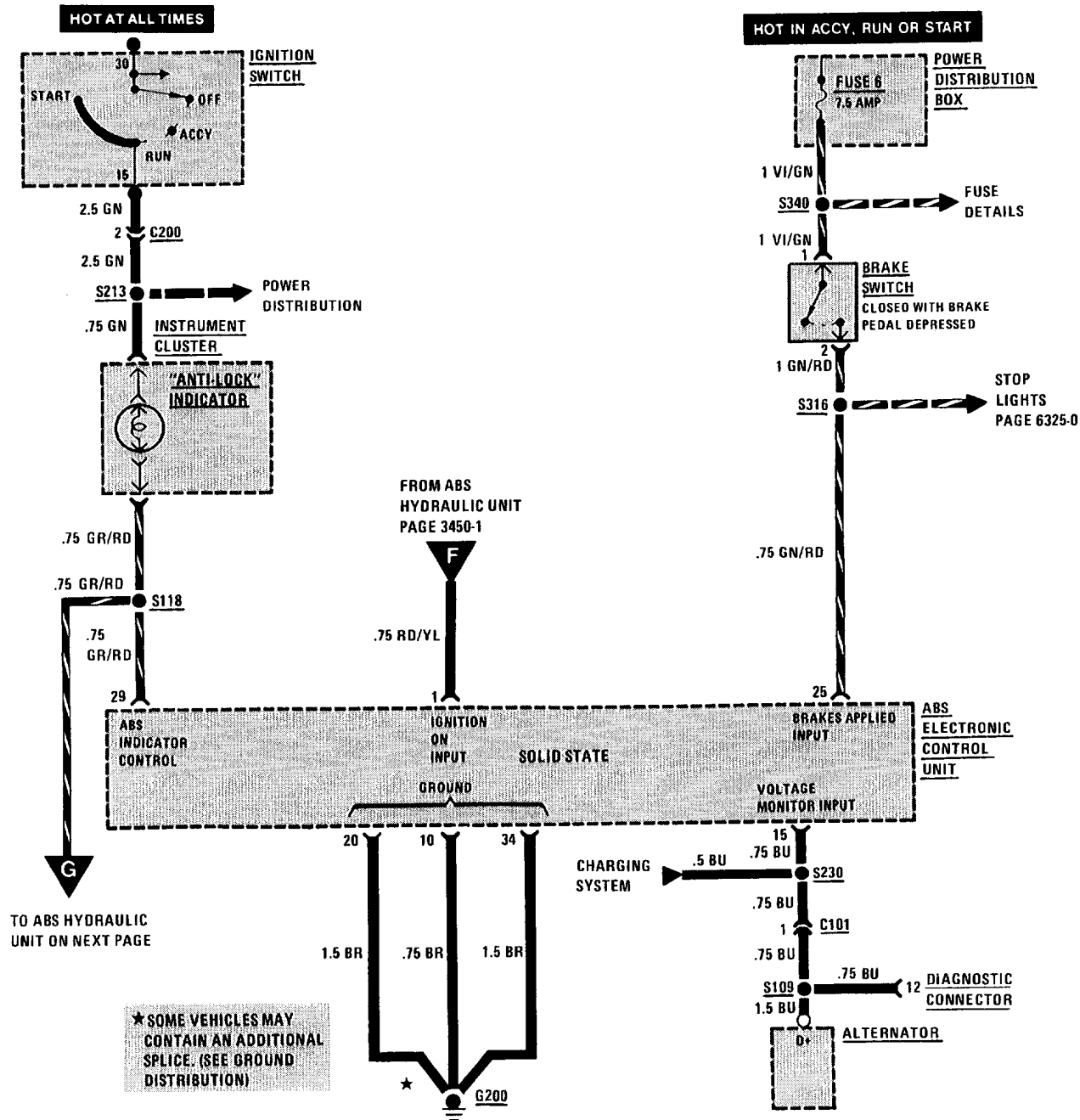

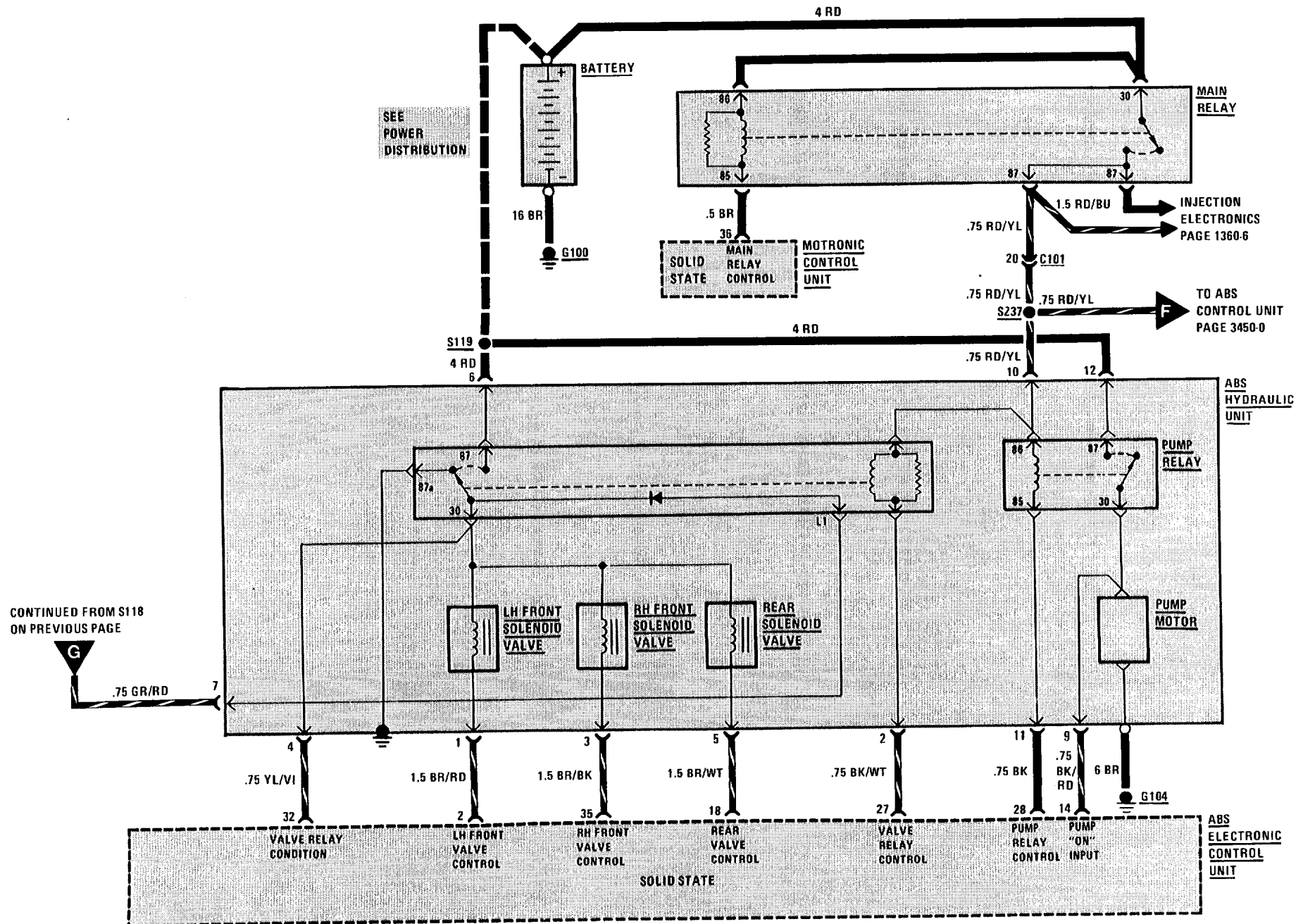

3450-2 ANTILOCK BRAKING SYSTEM (ABS)

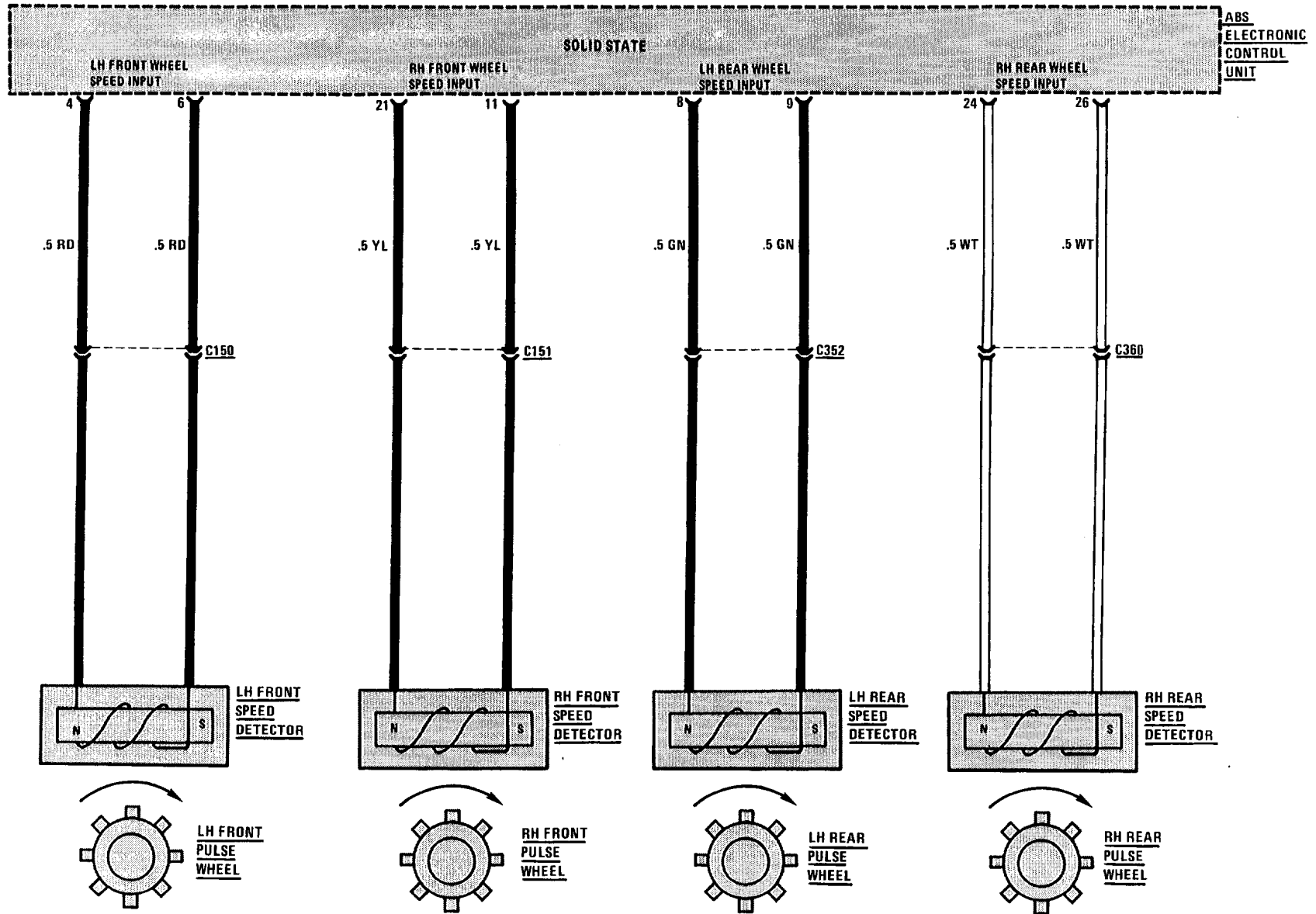

5116-0 POWER MIRRORS

HOT IN RUN ONLY FROM UNLOADER RELAY K7

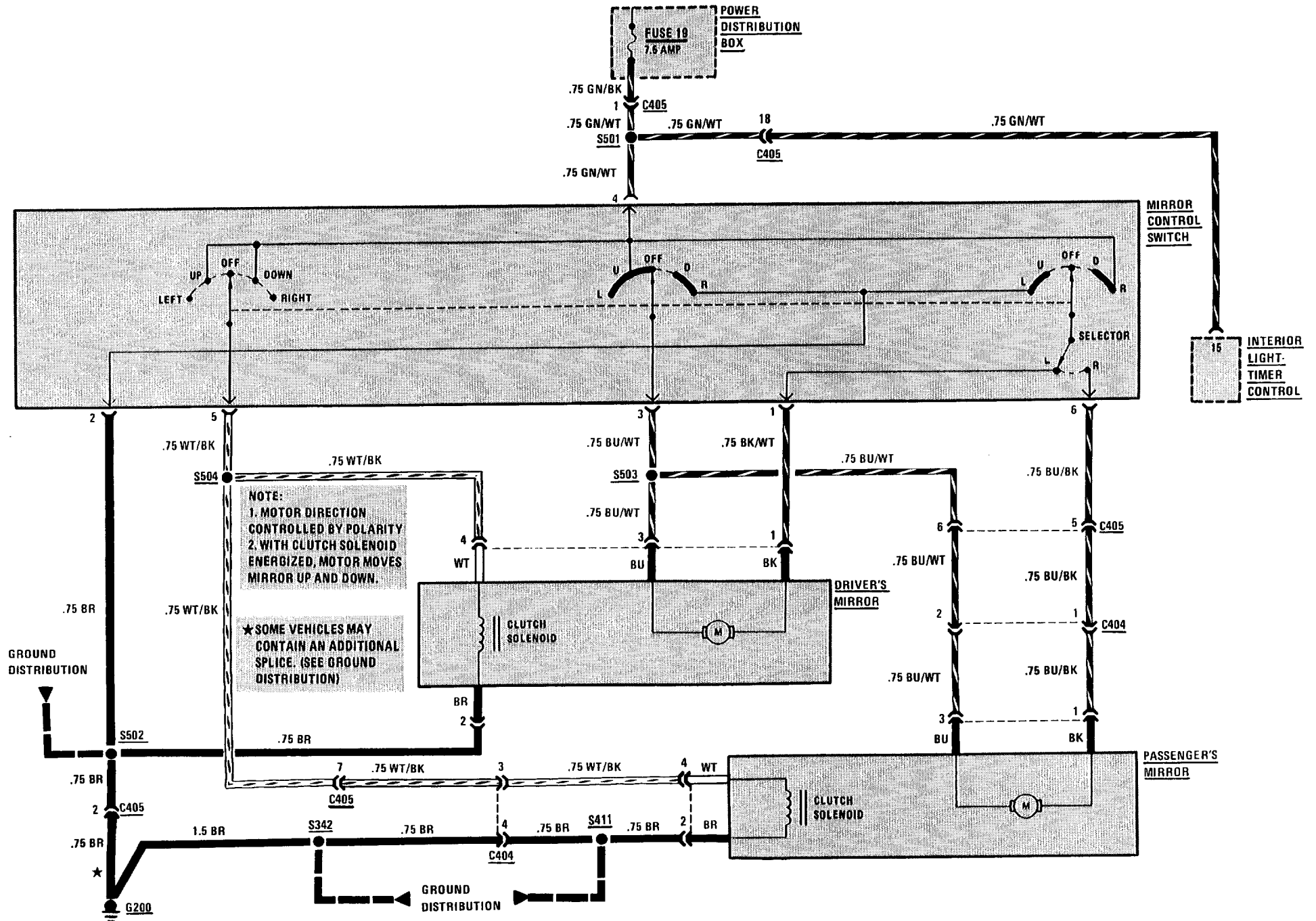

5126-0 CENTRAL LOCKING

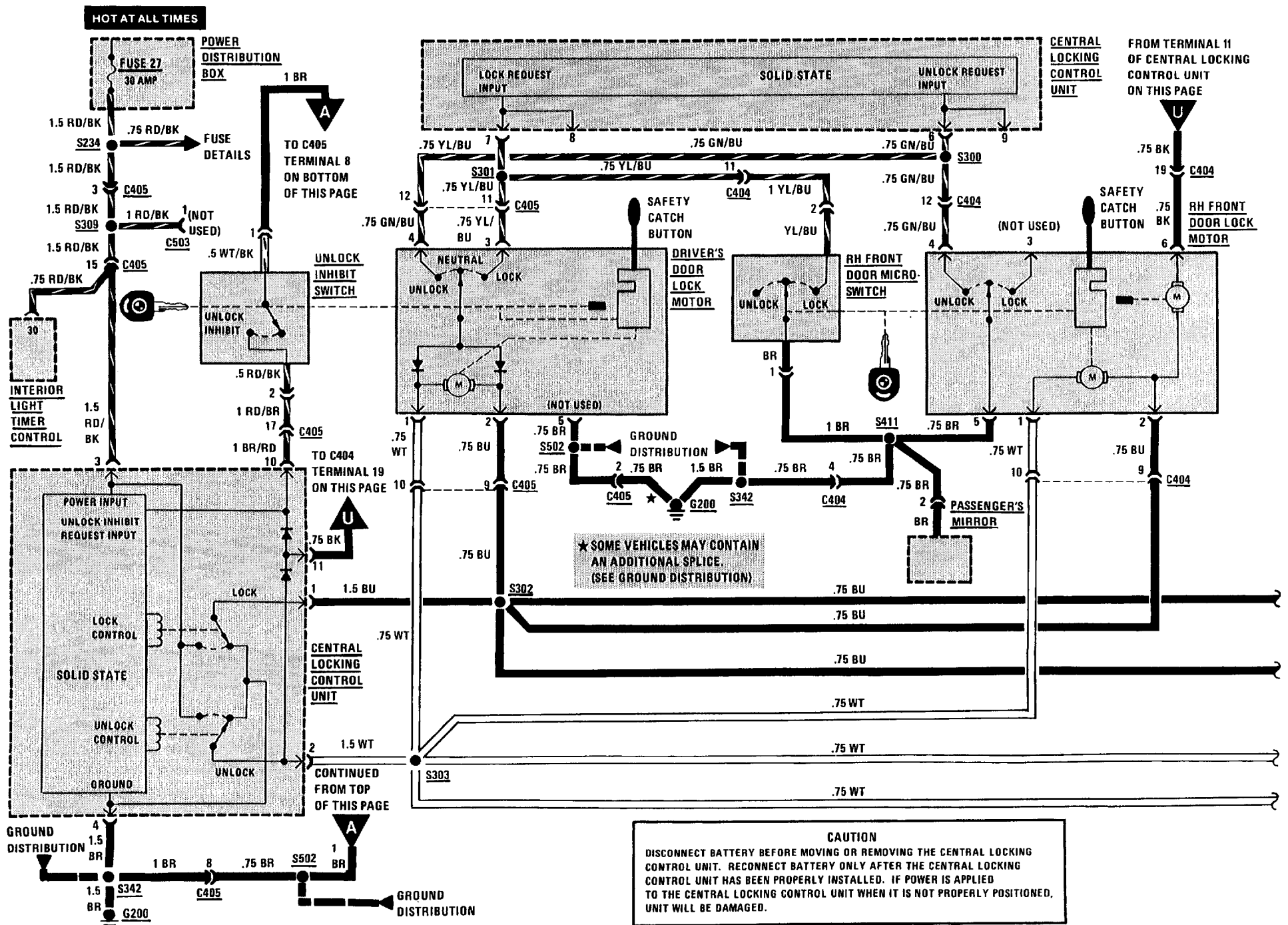

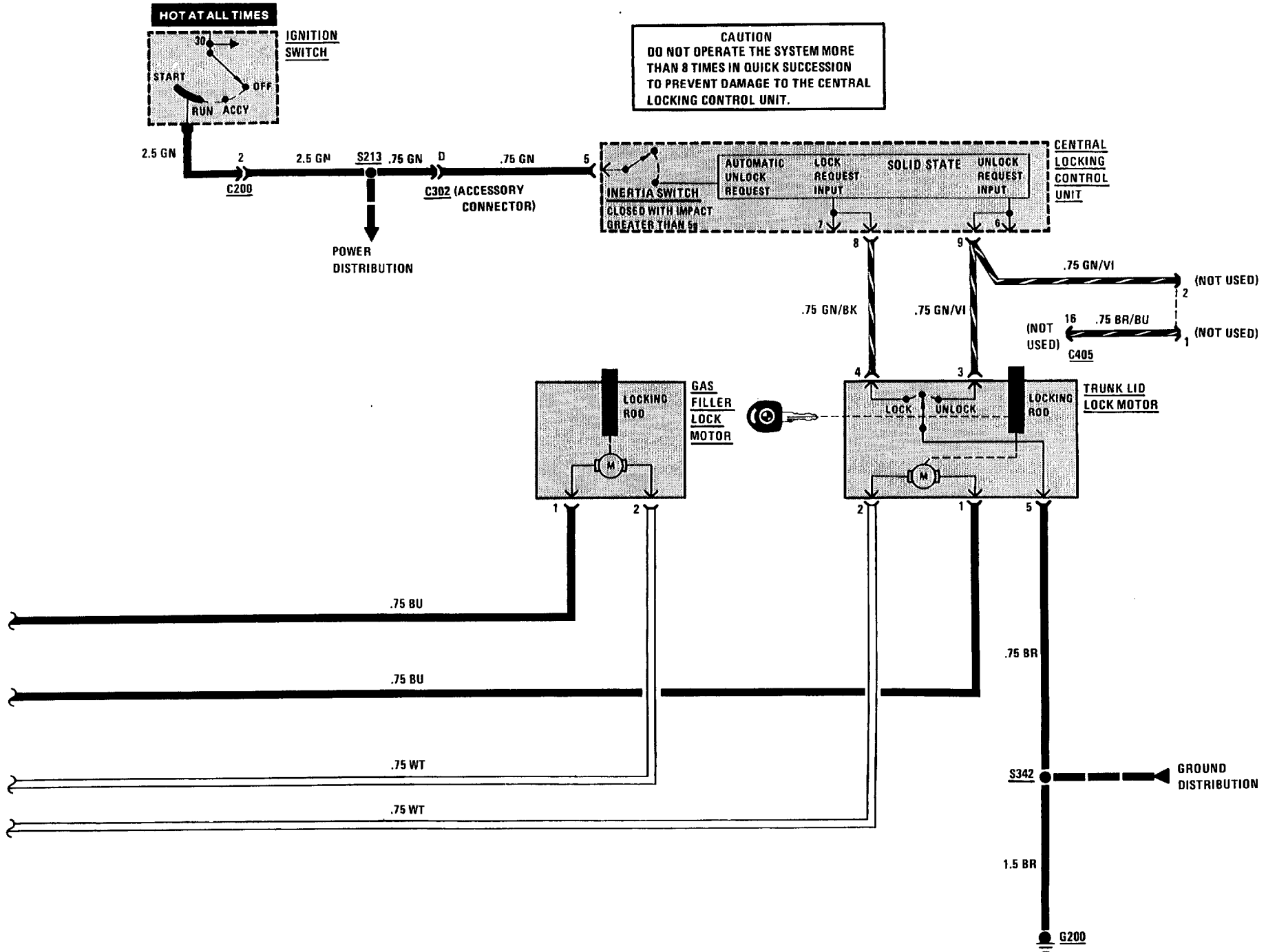

5126A-0 CENTRAL LOCKING

TROUBLESHOOTING HINTS

1. Check Fuse by operating the Interior Light Timer for either Dome Light.
2. If all locks stay in Unlock Inhibit, check the wires to terminal 10 of the Central Locking Unit for a short to ground.

SYSTEM CHECK

- Operate controls in sequence listed in the System Check Table.
- Refer to Repair Action for the Response received (tests follow the System Check Table).
- After any repair, repeat System Check to verify proper system operation.

NOTE: Before replacing any system component, check all connectors, splices, and wiring to that component.

SYSTEM CHECK TABLE

OPERATION	RESPONSE	REPAIR ACTION
1. Insert the key in the Driver's door and turn to LOCK	All doors lock	None, proceed to Operation 2
	Some doors lock	Repair/replace the suspect Door Lock Motor Circuit
	No doors lock	Proceed to Operation 4
2. Turn the key to UNLOCK INHIBIT (clockwise until key is horizontal)	All doors double lock (Safety Catch Buttons cannot be pulled up by hand)	None, proceed to Operation 3
	Driver's door double locks and only some of the other doors double lock	Repair/replace the suspect Door Lock Motor
	Driver's door double locks but all the other doors do not double lock	Perform Test B
	Driver's door does not double lock	Mechanical problem, see BMW Workshop Manual

SYSTEM CHECK TABLE (CONT'D)

OPERATION	RESPONSE	REPAIR ACTION
3. Turn the key to UNLOCK	All doors unlock	None, proceed to Operation 4
	Some doors unlock	Repair/replace the suspect Door Lock Motor circuit
	No doors unlock	Proceed to Operation 5
4. Insert the key in the Passenger's door and turn to LOCK	All doors lock	If the doors did not lock in Operation 1, repair/replace the Driver's Door Lock Switch, otherwise proceed to Operation 5
	Some doors lock	Repair/replace the suspect Door Lock Motor circuit
	No doors lock	If all the doors locked in Operation 1, repair/replace the Right Front Door Microswitch. If the doors did not lock in Operation 1, perform Test A
5. Insert the key in the Passenger's door and turn to UNLOCK	All doors unlock	If all the doors did not unlock in Operation 3, repair/replace the Driver's Door Lock Switch, otherwise proceed to Operation 6
	Some doors unlock	Repair/replace the suspect Door Lock Motor
	No doors unlock	If all the doors unlocked in Operation 3, repair/replace the Passenger's Door Lock Switch. If the doors did not unlock in Operation 3, perform Test C
6. Get in the car and close and lock all doors Turn the Ignition Switch to RUN	Doors remain locked	None, proceed to Operation 7
	Doors unlock	Repair/replace the Central Locking Control Unit
7. Get out of the car Insert the key in the Driver's door and turn to LOCK Unlock each of the doors by pulling up the Safety Catch Buttons	All doors can be unlocked	None, proceed to Operation 8
	All doors remain secure	Disconnect the connector from the Central Locking Control Unit and check for a short to ground in the wires at terminal 11. <ul style="list-style-type: none"> • If short to ground is not present, replace the Central Locking Control Unit. • If short to ground is present isolate wiring from Door Lock Motors one at a time to find short

5126A-2 CENTRAL LOCKING

SYSTEM CHECK TABLE (CONT'D)

OPERATION	RESPONSE	REPAIR ACTION
8. Insert the key in the Trunk Cylinder Switch. Turn the key to LOCK	Trunk locks	None, proceed to Operation 9
	Trunk does not lock	If the doors lock, repair/replace the Trunk Lock Motor Circuit or Trunk Lock Motor If the doors do not lock, repair/replace the Trunk Switch Repair/replace the Central Locking Control Unit if the Trunk Switch Circuit is OK
9. Turn the key to UNLOCK	Trunk unlocks	None, proceed to Operation 10
	Trunk does not unlock	If the doors unlock, repair/replace the Trunk Lock Motor circuit or Trunk Lock Motor If the doors do not unlock, repair/replace the Trunk Switch Repair/replace the Central Locking Control Unit if the Trunk Switch Circuit is OK
10. Turn the key back to LOCK	Gas Filler locks	None, proceed to Operation 11
	Gas Filler does not lock	Repair/replace the Gas Filler Lock Motor circuit
11. Turn the key to UNLOCK	Gas Filler unlocks	None
	Gas Filler does not unlock	Repair/replace the Gas Filler Lock Motor circuit

- If all results are normal, the system is OK.

SYSTEM DIAGNOSIS

- Do the following tests when directed by the System Check Table.

A: CONTROL UNIT LOCK TEST (TABLE 1)

Measure: VOLTAGE At: CONTROL UNIT CONNECTOR (Connected)		
Measure Between	Correct Voltage	For Diagnosis
3 & Ground	Battery	See 1
3 & 4	Battery	See 2
<ul style="list-style-type: none"> • If the voltages are correct, proceed to Table 2. <ol style="list-style-type: none"> 1. Check the wire to terminal 3 for an open. 2. Check the wire from terminal 4 for an open to ground (see schematic). 		

A: CONTROL UNIT LOCK TEST (TABLE 2)

Connect: A FUSED JUMPER At: CONTROL UNIT CONNECTOR (Connected)		
Jumper Between	Correct Result	For Diagnosis
7 & Ground	Doors lock	See 1
<ul style="list-style-type: none"> • If the result is correct, repair/replace the switches and related wiring (see schematic). <ol style="list-style-type: none"> 1. Proceed to Table 3. 		

**A: CONTROL UNIT LOCK TEST
(TABLE 3)**

Connect: FUSED JUMPERS At: CONTROL UNIT CONNECTOR (Disconnected)		
Jumper Between	Correct Result	For Diagnosis
1 & 3 2 & 4	Doors lock	See 1
<ul style="list-style-type: none"> If the result is correct, replace the Central Locking Control Unit. <ol style="list-style-type: none"> Check wire from terminal 1 to splice and wire from terminal 3 to splice for opens (see schematic). 		

B: UNLOCK INHIBIT TEST

Connect: A FUSED JUMPER At: CONTROL UNIT CONNECTOR (Connected)		
Jumper Between	Correct Result	For Diagnosis
10 & Ground	Doors double lock	See 1
<ul style="list-style-type: none"> If the result is correct, check the wires from terminal 10 to ground for opens (see schematic). Replace the Unlock Inhibit Switch if the wires and connections are OK. <ol style="list-style-type: none"> Check the wires from terminal 11 for opens (see schematic). If the wires and connections are OK, replace the Central Locking Control Unit. 		

C: CONTROL UNIT UNLOCK TEST

Connect: A FUSED JUMPER At: CONTROL UNIT CONNECTOR (Connected)		
Jumper Between	Correct Result	For Diagnosis
6 & Ground	Doors unlock	See 1
<ul style="list-style-type: none"> If the result is correct, repair/replace the switches and related wiring (see schematic). <ol style="list-style-type: none"> Replace the Central Locking Control Unit. 		

CIRCUIT DESCRIPTION

The Central Locking System is controlled by the Central Locking Control Unit. This unit senses when a lock switch is moved by a key and sends the appropriate signal to drive the Motors. The Central Locking Control Unit controls the Door Locks, Gas Filler Lock and Trunk Lock. The unit also has an Inertia Switch which closes on impact greater than 5g. If in RUN or START, the locks are then unlocked.

Lock

When the Key is inserted into a lock and turned clockwise, the Lock Switch moves to LOCK and grounds terminal 7 of the Central Locking Control Unit. The unit then activates the Lock Relay and applies voltage from Fuse 27 to the Lock Motor, which is grounded through the WT wire, Central Locking Control Unit and BR wire. The Lock Motor then pulls the lock down. The door locks also control the Trunk Lock and Gas Filler Lock.

Unlock

When the key is turned counterclockwise, terminal 6 of the Central Locking Control Unit is grounded through the Lock Switch. The Central Locking Control Unit activates the Unlock Relay and applies voltage from Fuse 27, through terminal 2 to the Lock Motor. The motor is grounded through the BU wire, Central Locking Control Unit terminal 1. The polarity is reversed and the motor pushes the lock up.

Unlock Inhibit

When the key is inserted into the Driver's Lock and turned clockwise past the LOCK position, the Unlock Inhibit mechanism is engaged. Mechanically inserting a bar into the driver's lock prevents unlocking through use of the Safety Catch Button. When in the Unlock Inhibit position, ground is applied to the Unlock Inhibit motors in the other lock units. The Central Locking Control Unit is grounded at terminal 10 and then activates the Lock Relay. Voltage is applied to the Unlock Inhibit motors through terminal 1. They are activated and engage the other Unlock Inhibit mechanisms. The direction of the motors is reversed when the doors are unlocked (see Unlock).

Trunk Lock

The Trunk Lock operates in a manner similar to the Door Locks.

5133-0 POWER WINDOWS

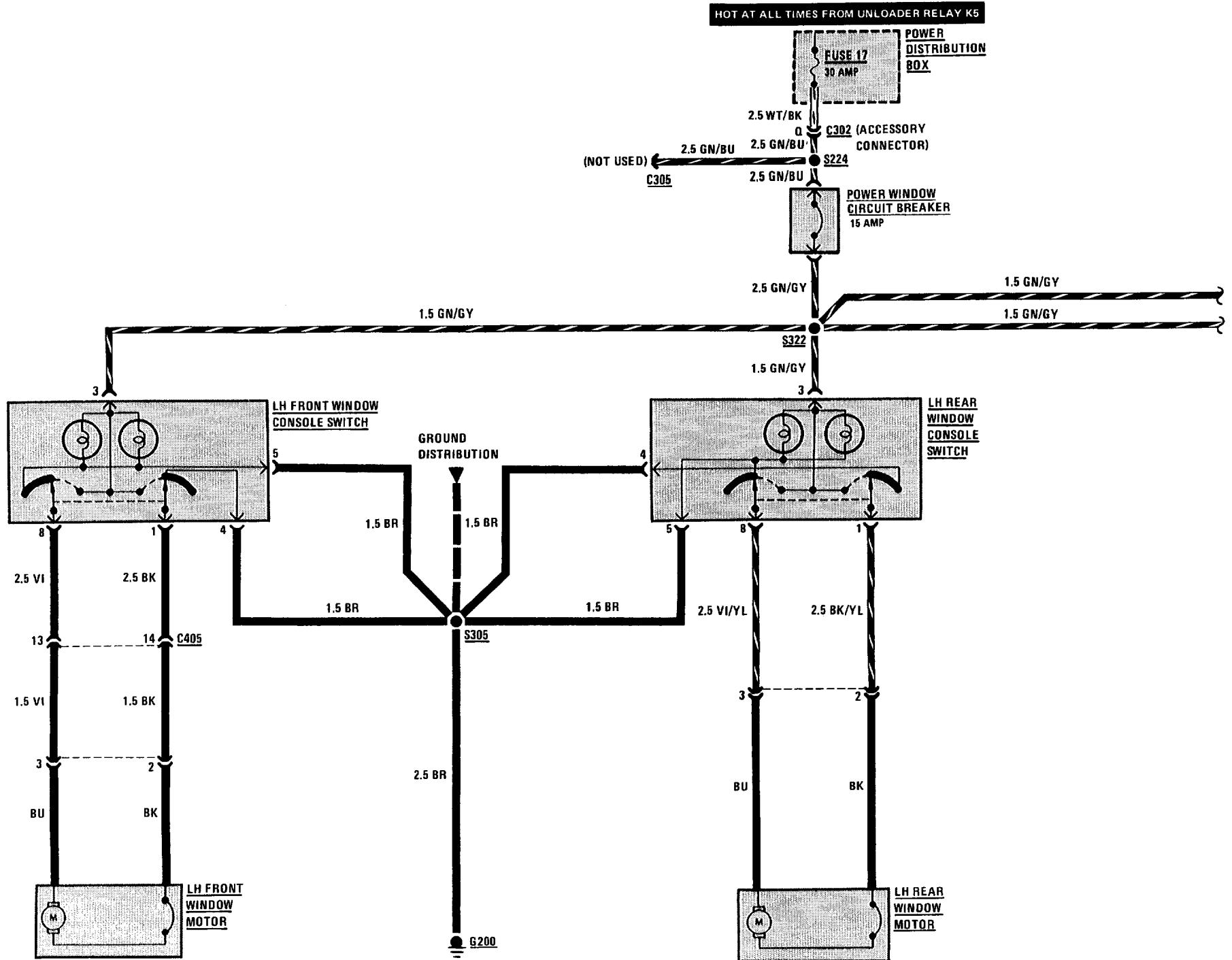

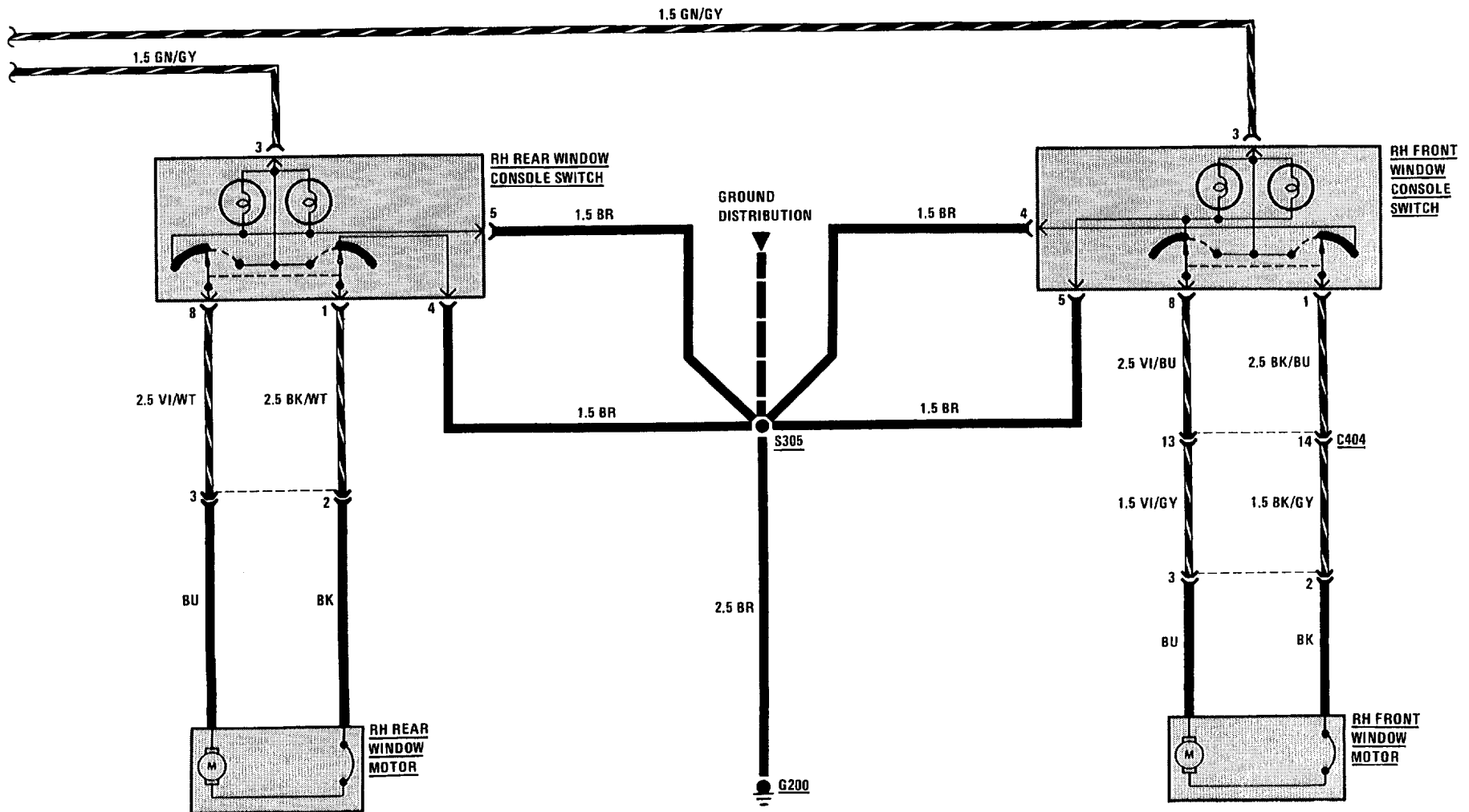

HEATED SEATS

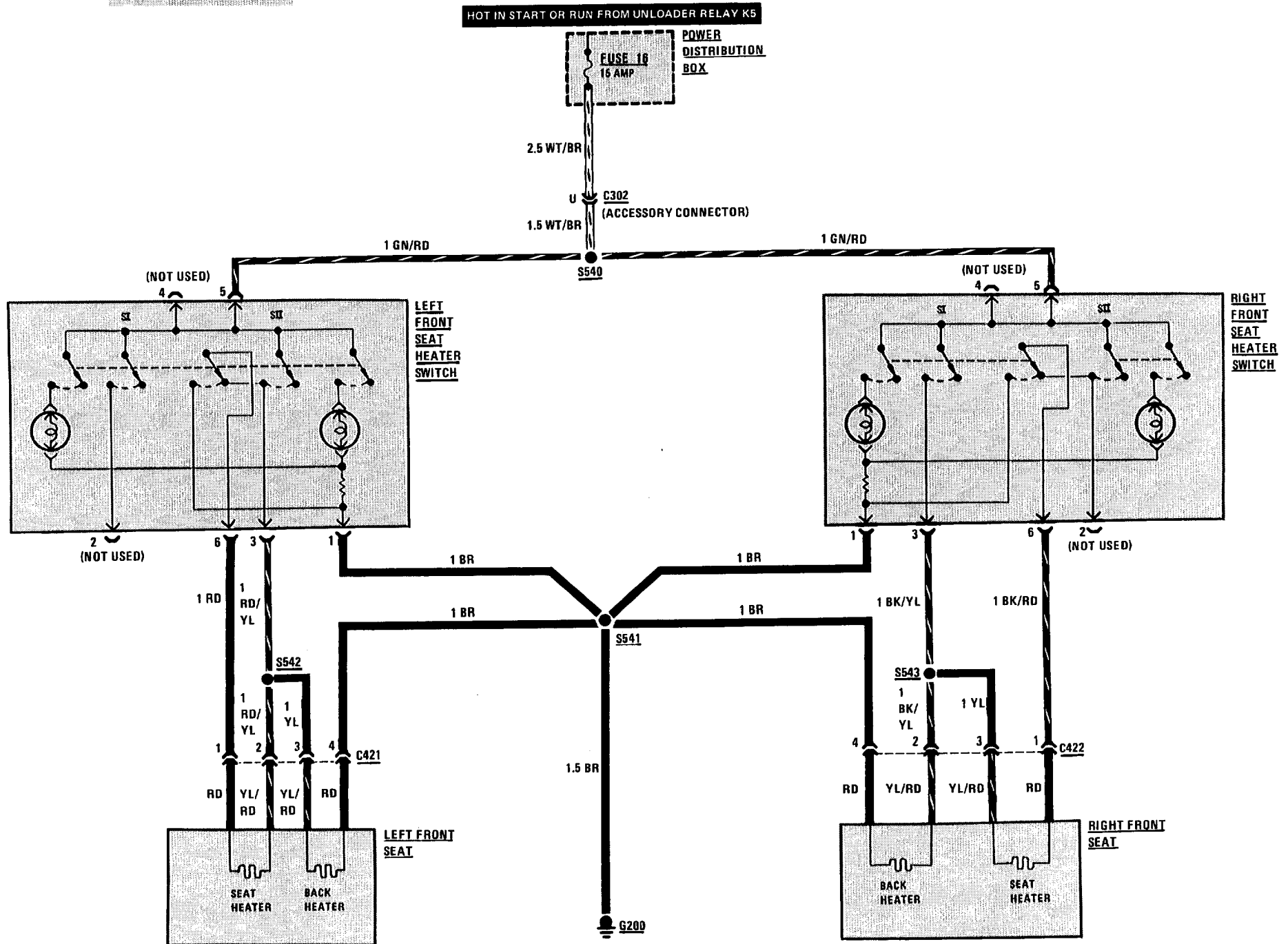

5400-0 ELECTRO-MECHANICAL CONVERTIBLE TOP

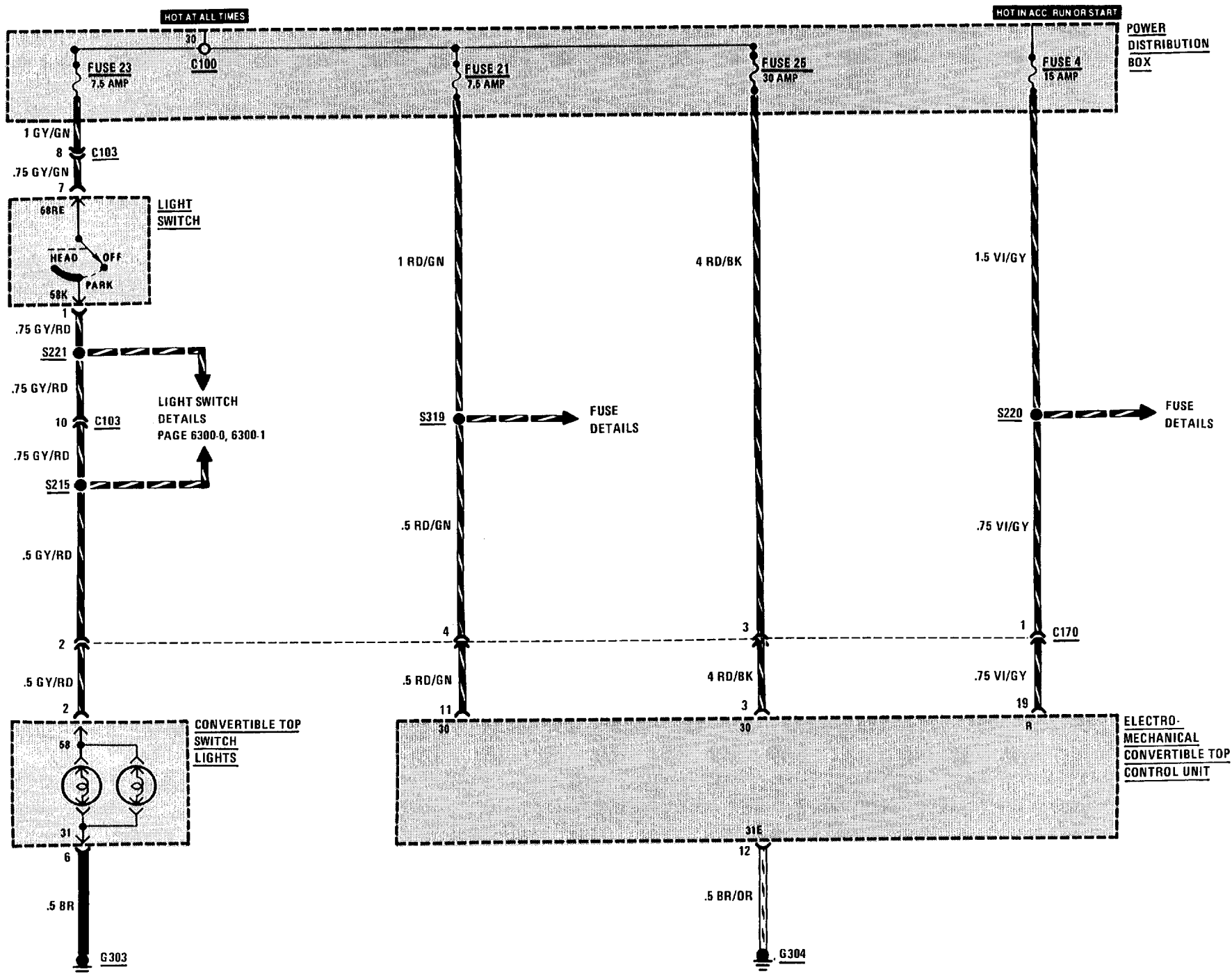

ELECTRO-MECHANICAL CONVERTIBLE TOP 5400-1

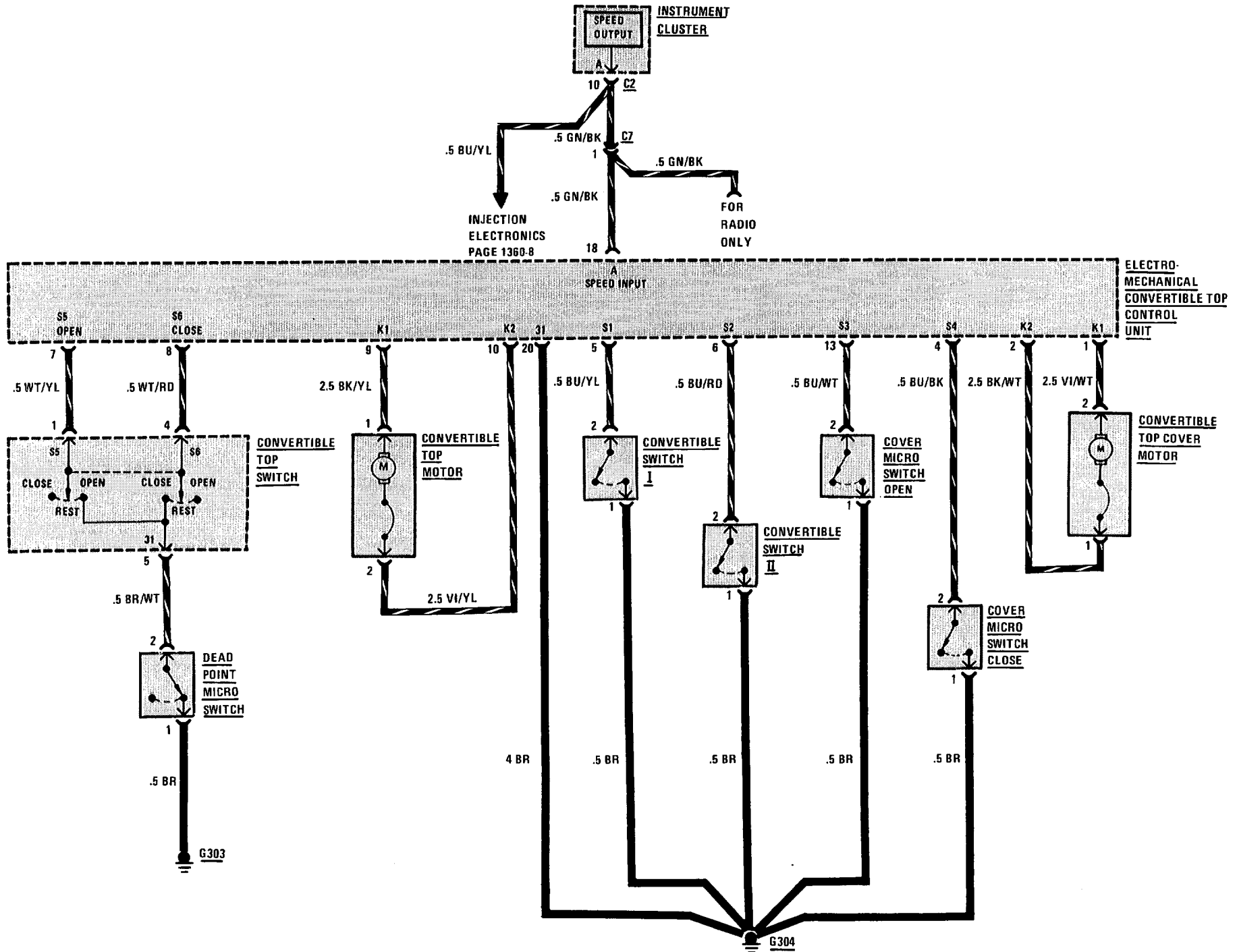

6100-0 BODY ELECTRICAL

HORNS

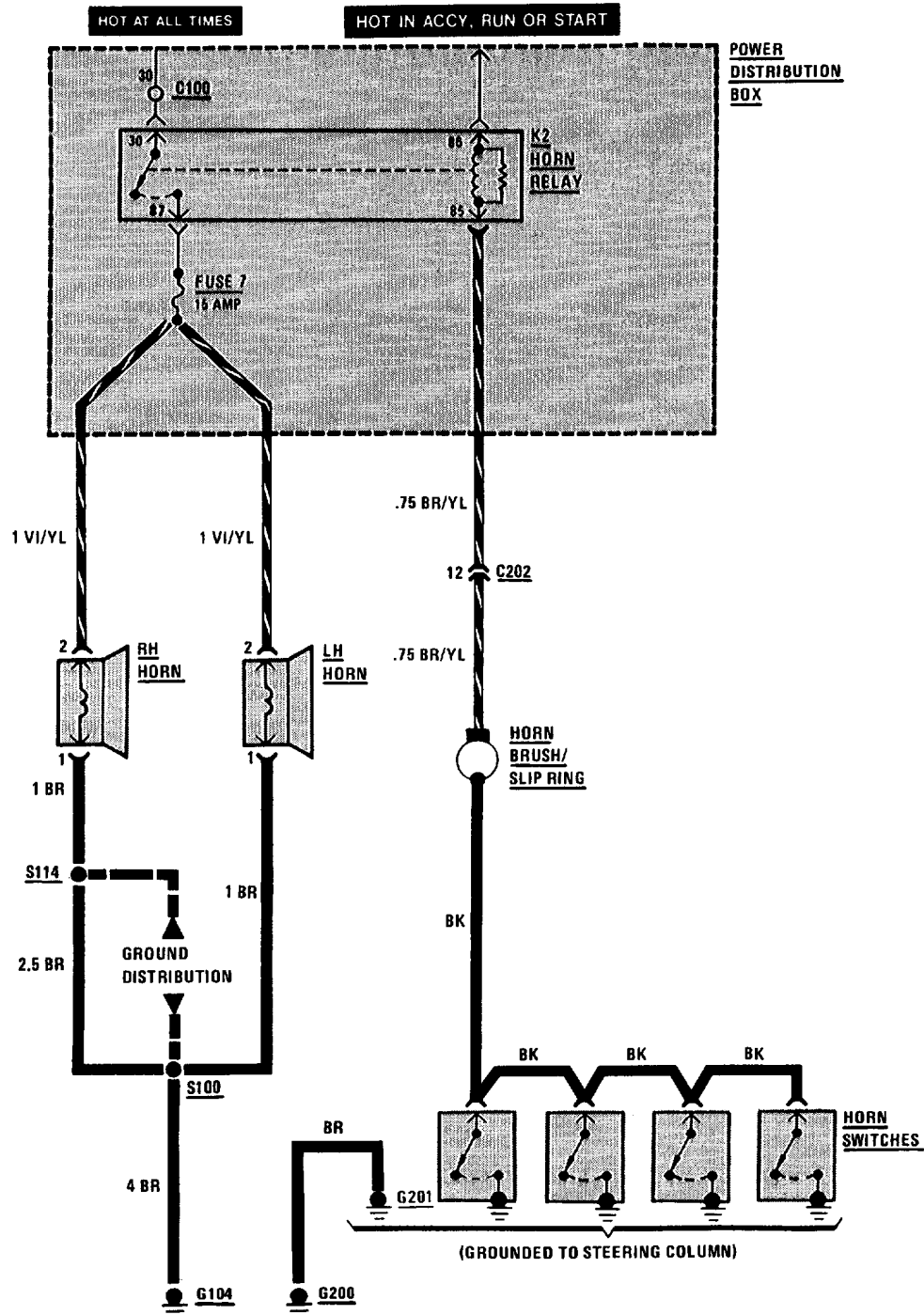

CIGAR LIGHTER/GLOVE BOX LIGHT/AUTO-CHARGING FLASHLIGHT/MAP READING LIGHT

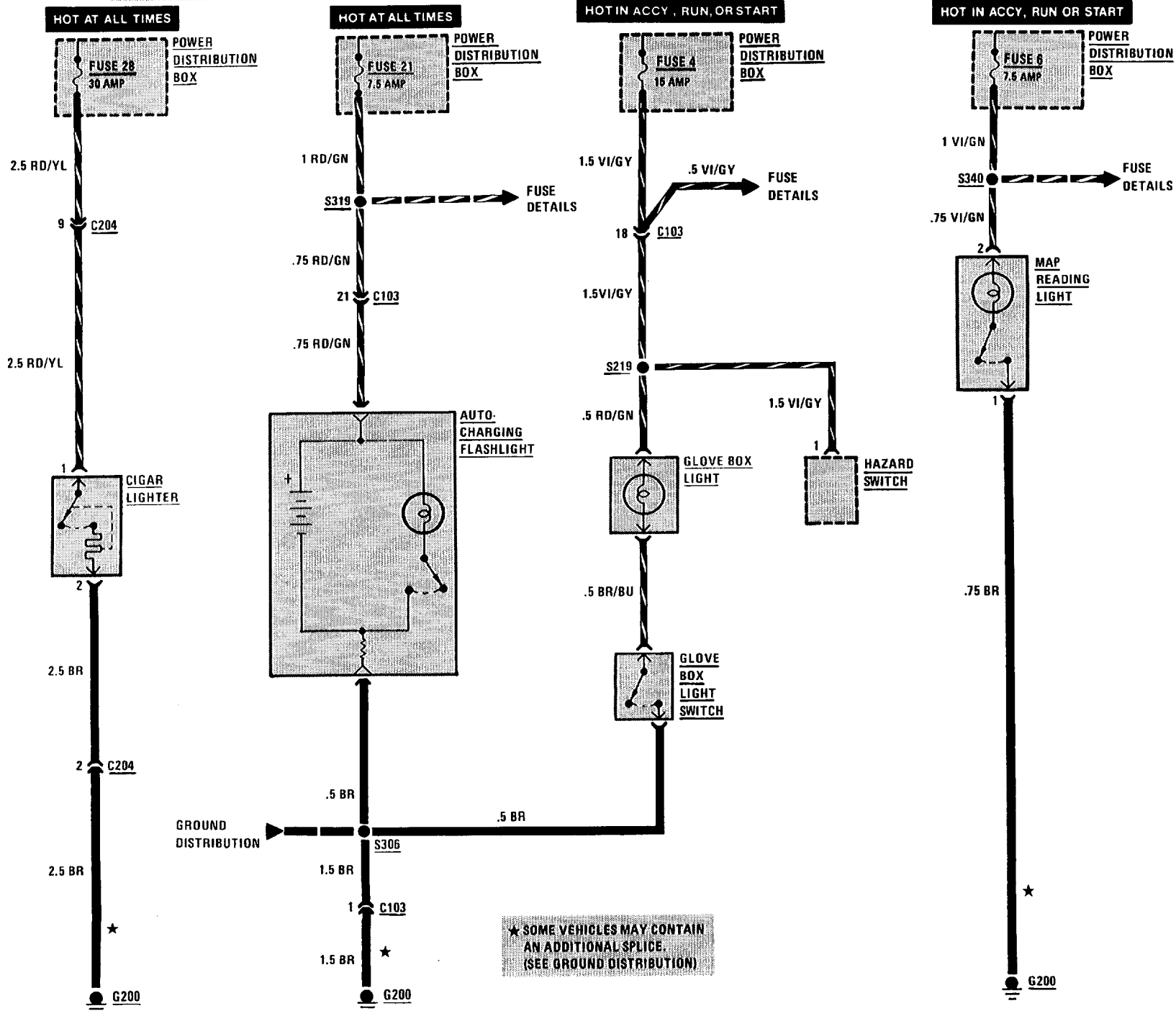

6100-2 BODY ELECTRICAL

REAR DEFOGGER

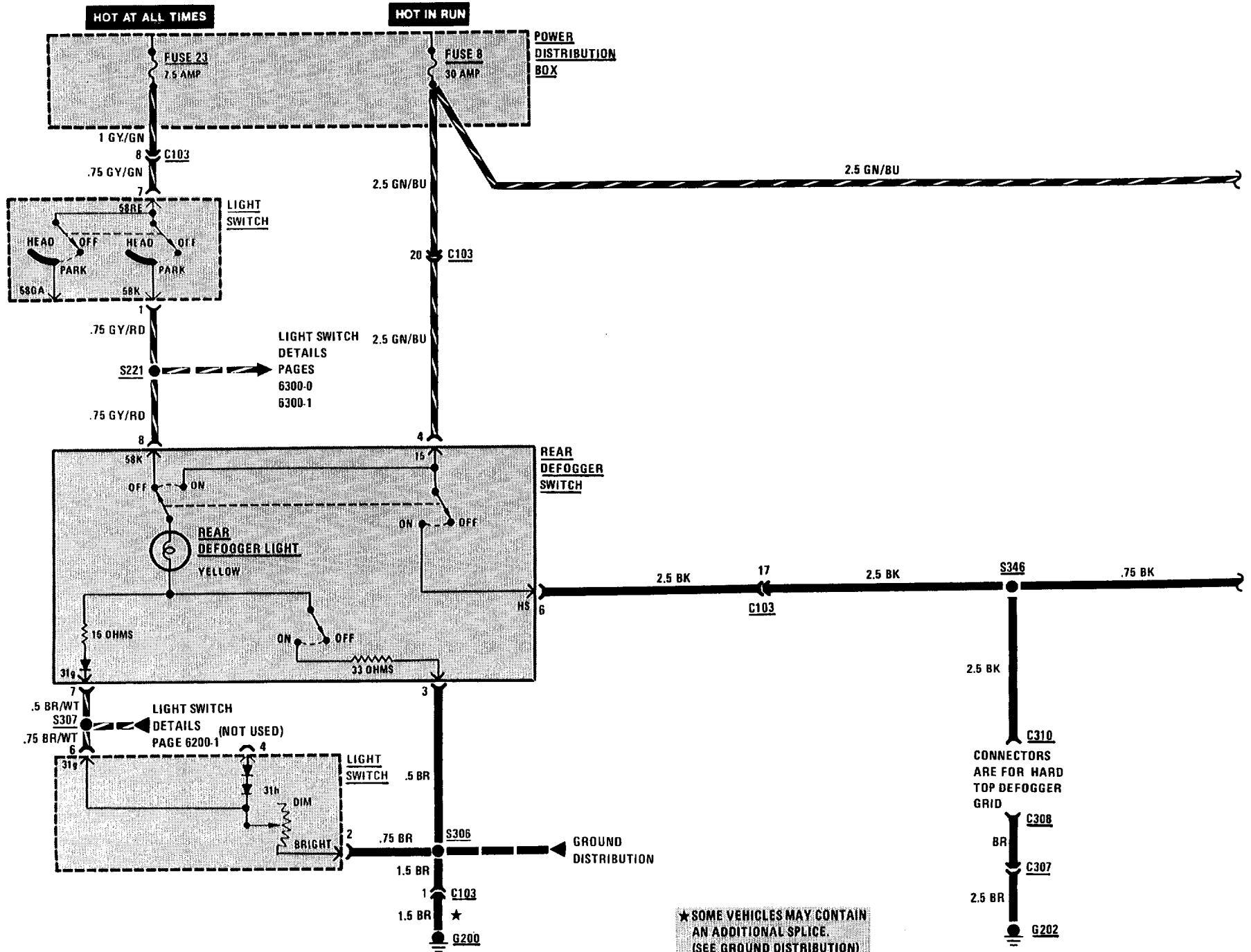

REAR DEFOGGER

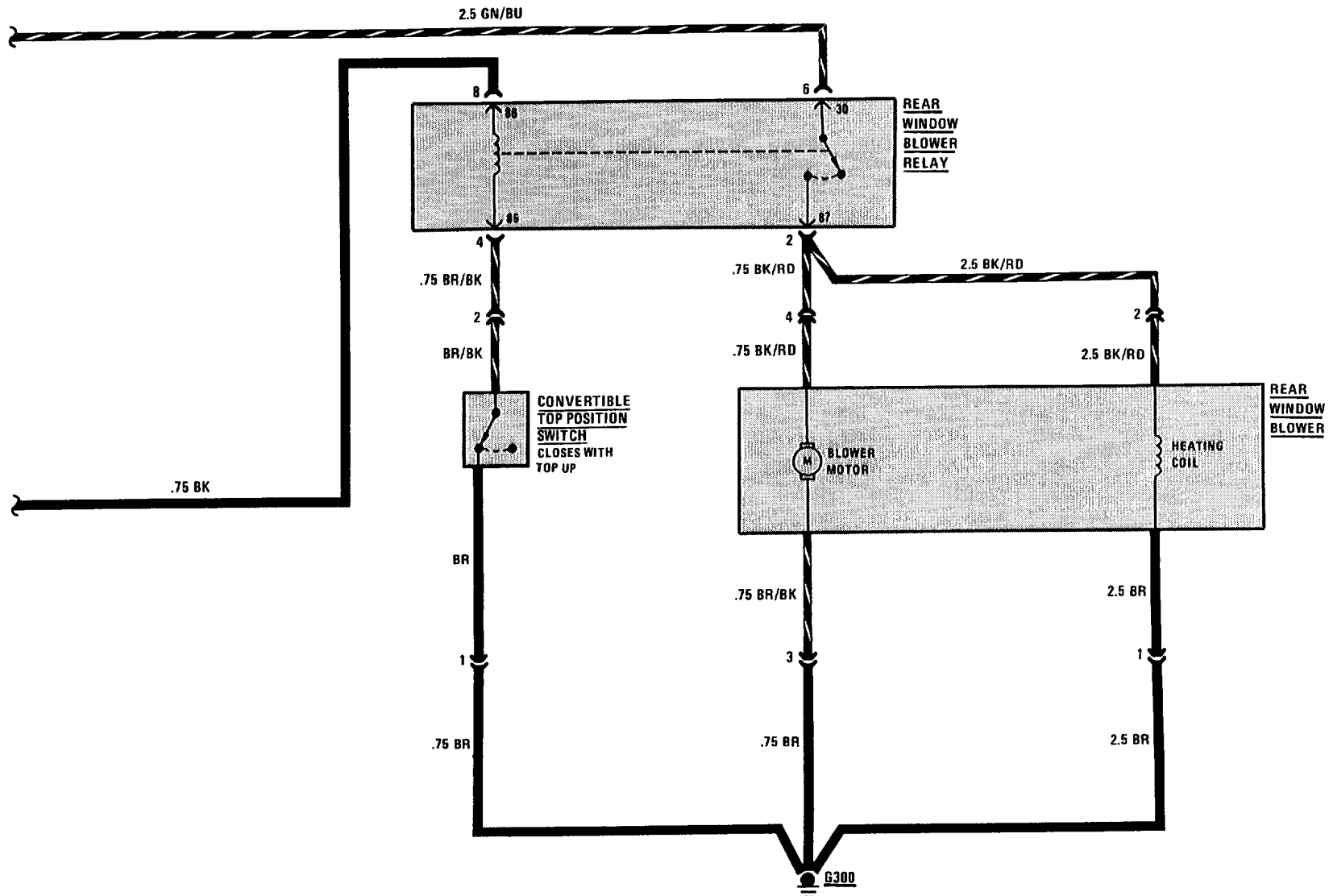

6131-0 IGNITION KEY WARNING/SEATBELT WARNING

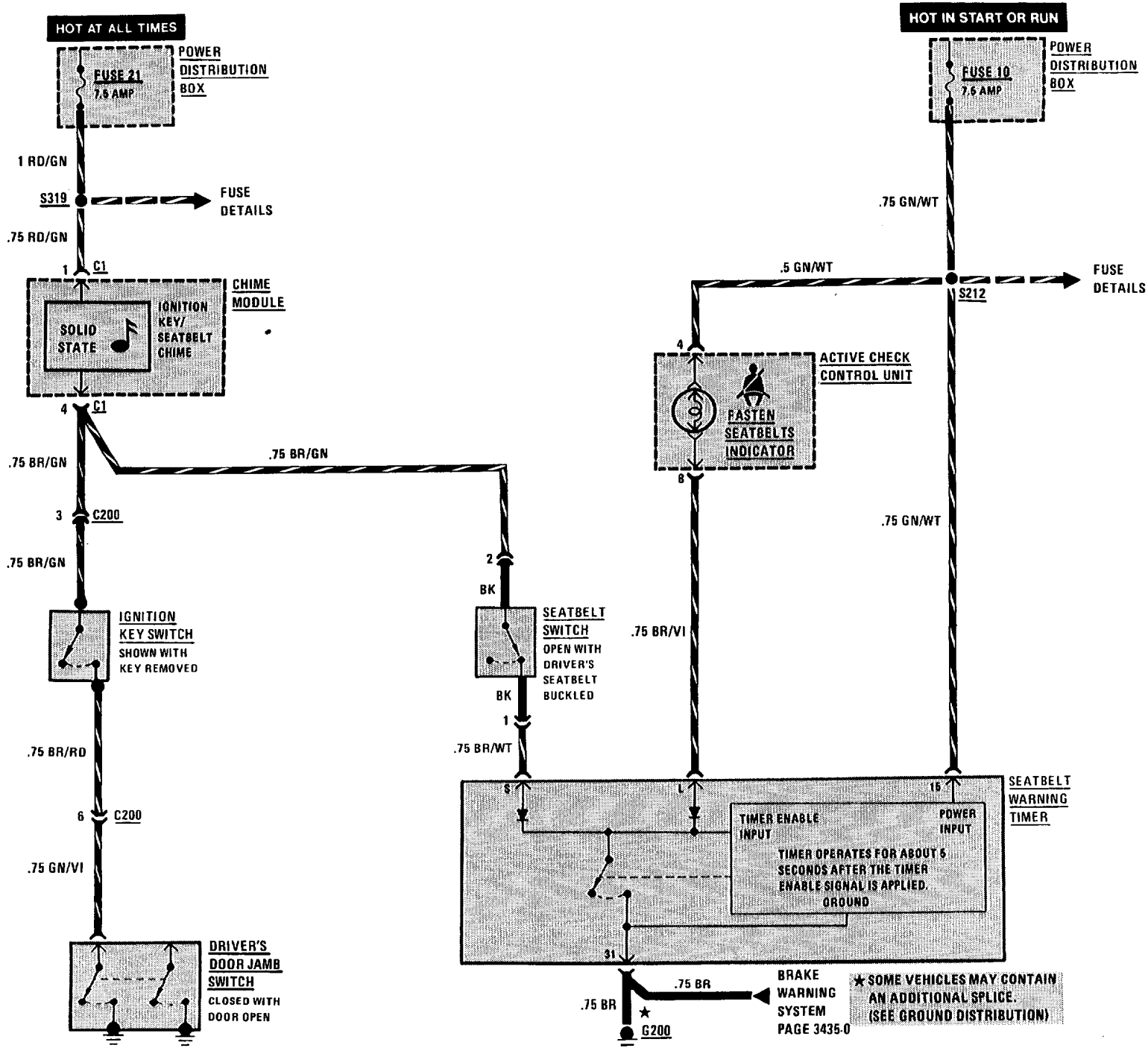

6160-0 WIPER/WASHER

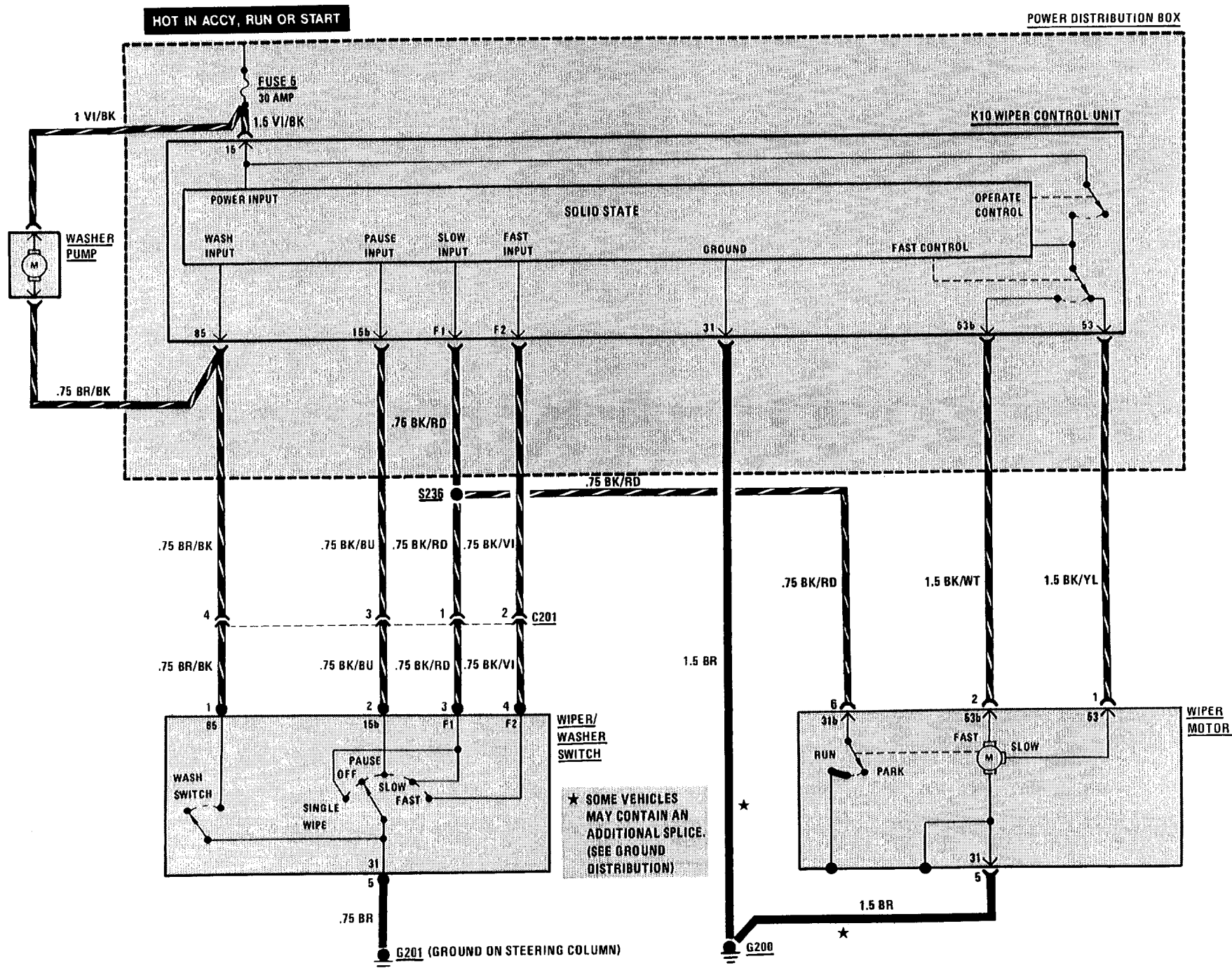

6210-0 INSTRUMENT CLUSTER

SPEEDOMETER/INDICATORS

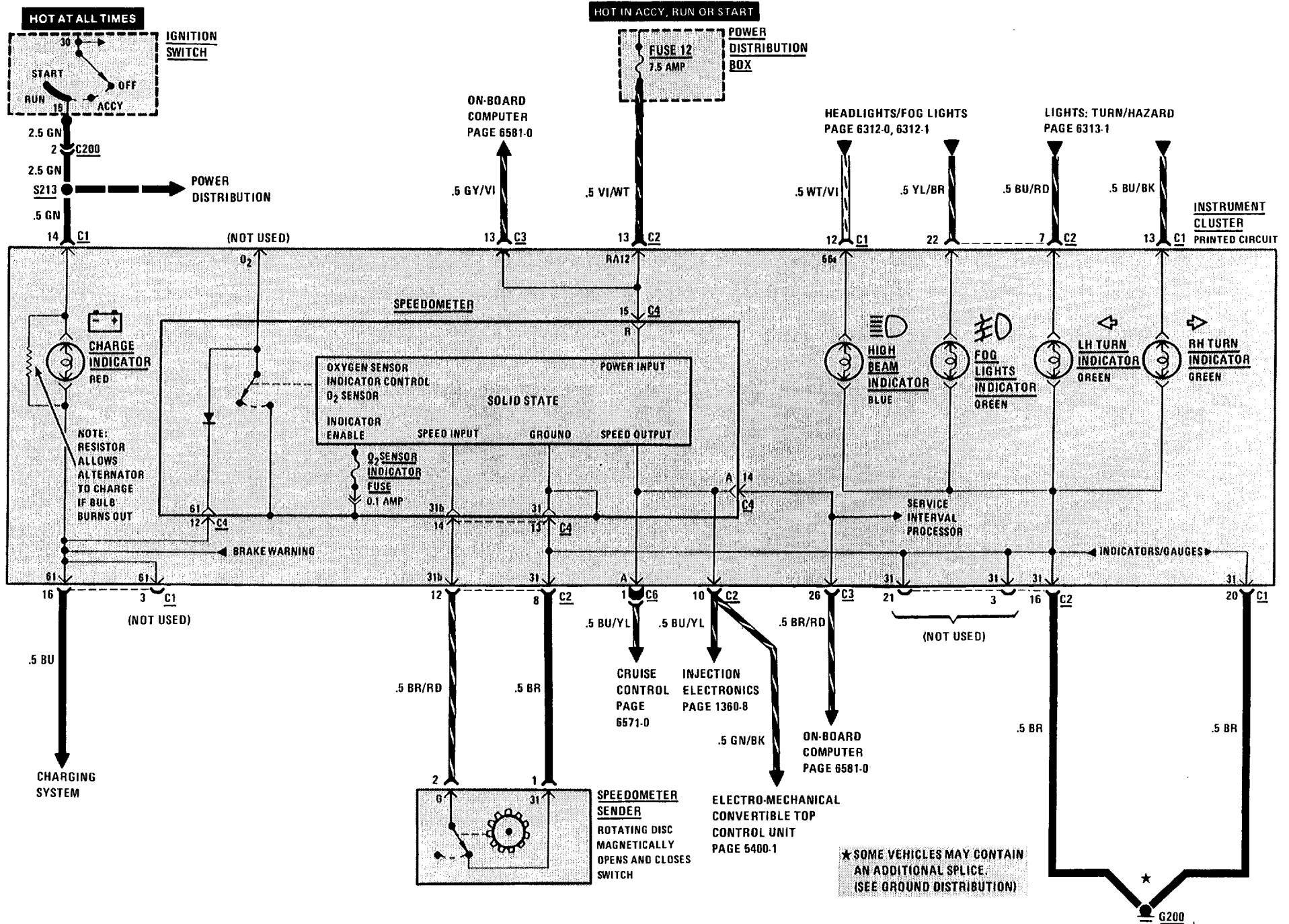

GAUGES/INDICATORS

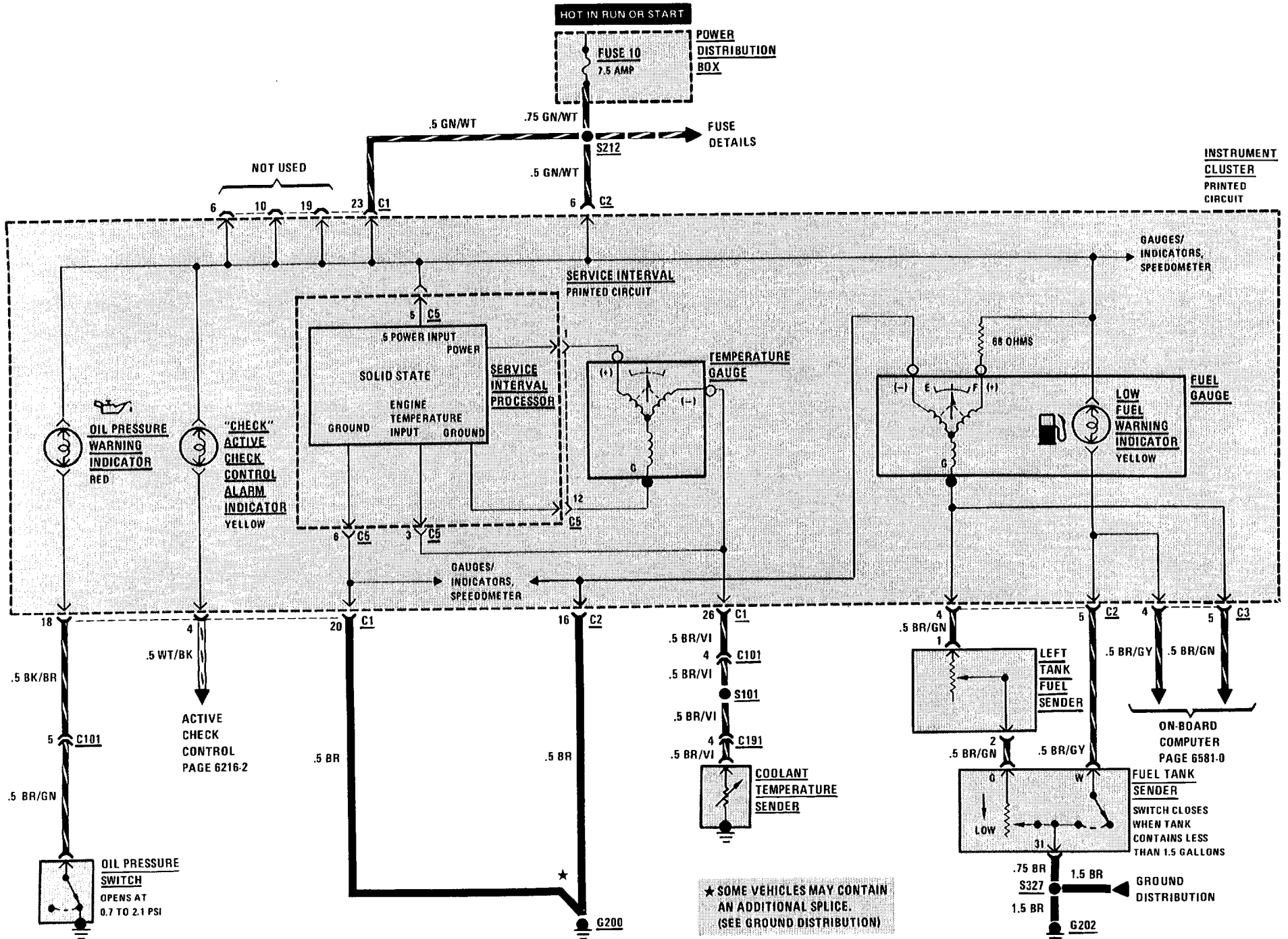

6210-2 INSTRUMENT CLUSTER

SERVICE INTERVAL INDICATOR

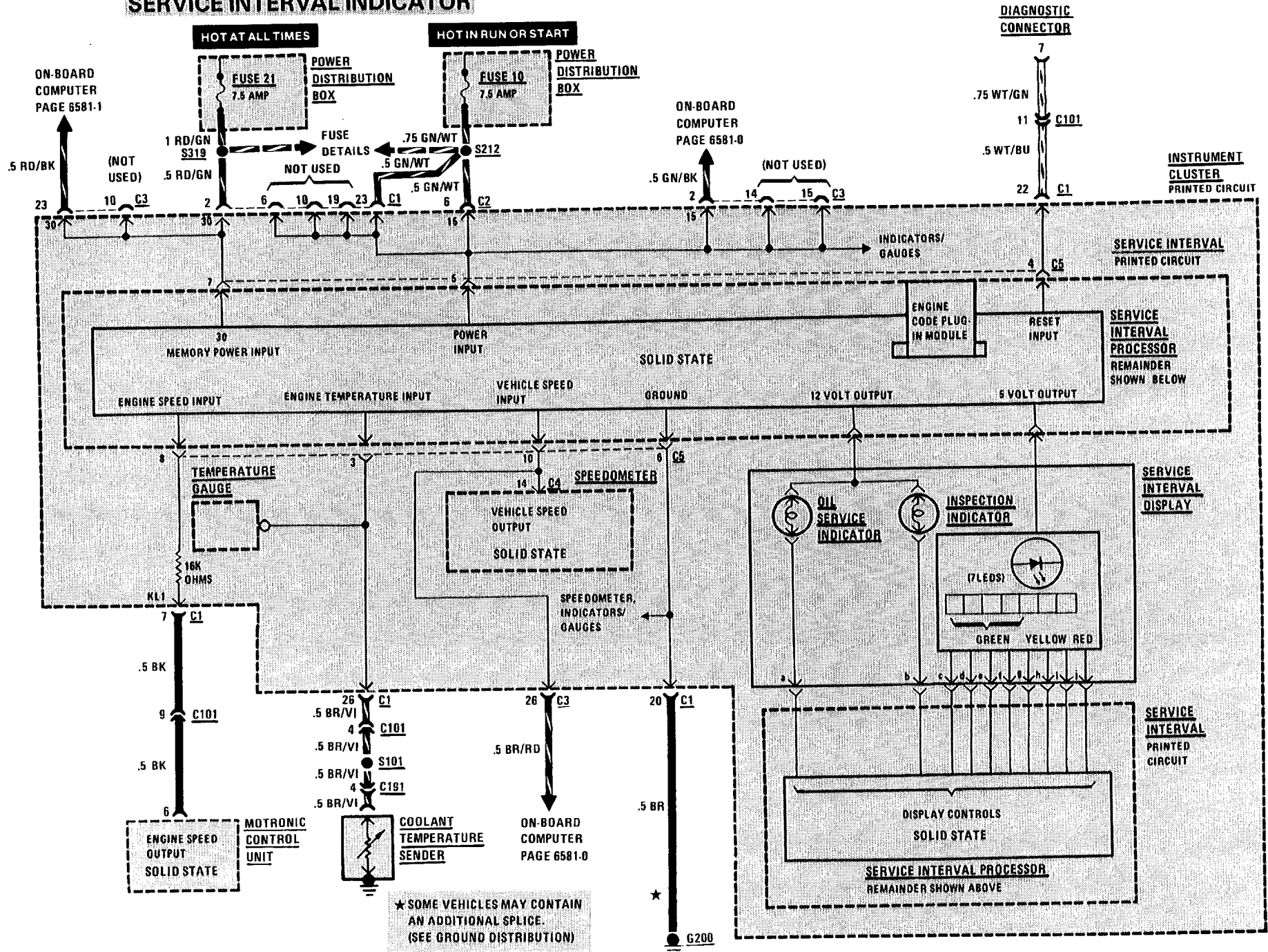

TACHOMETER/FUEL ECONOMY GAUGE

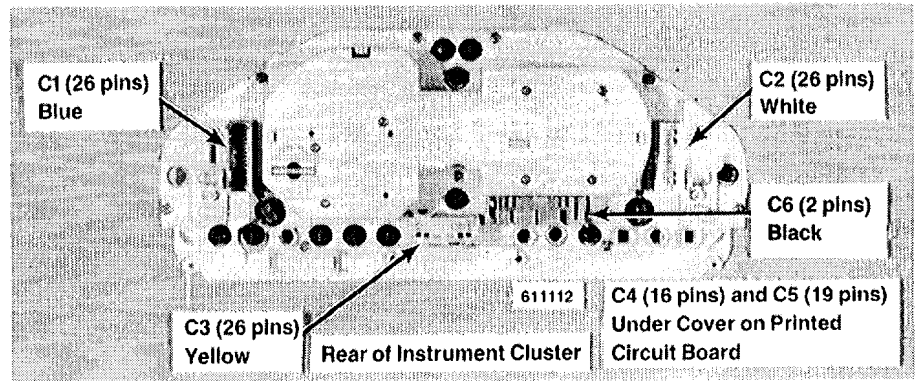
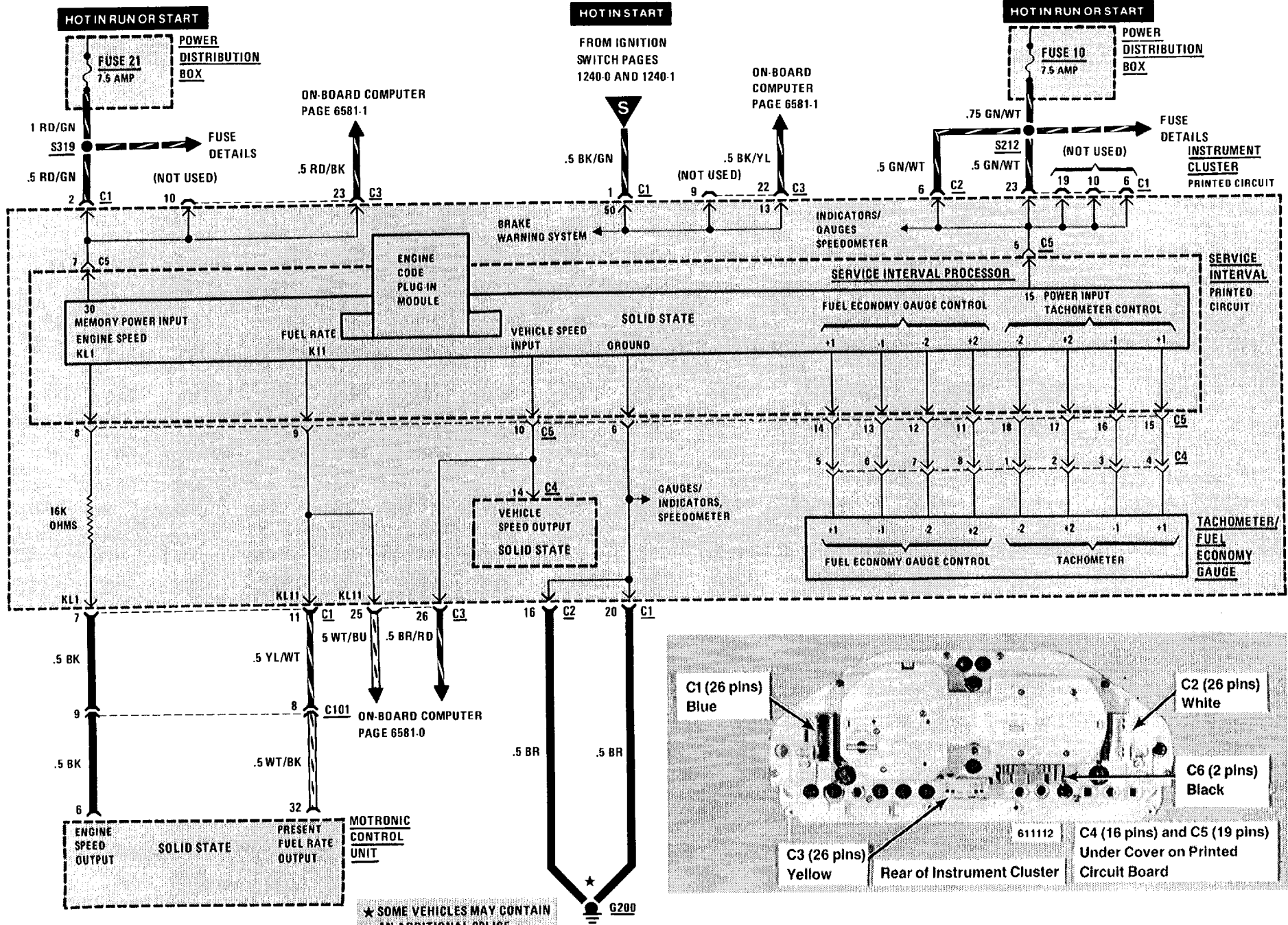

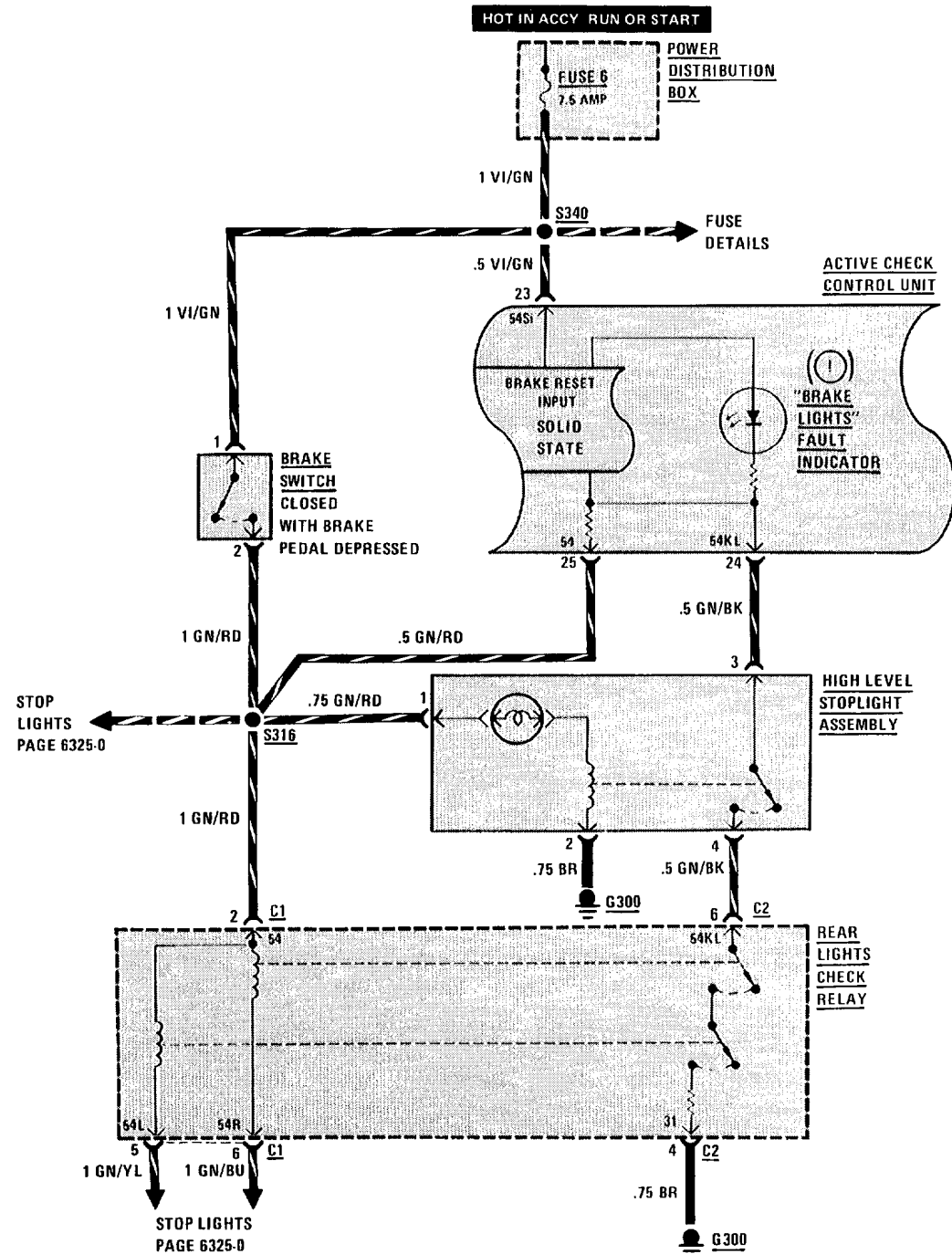
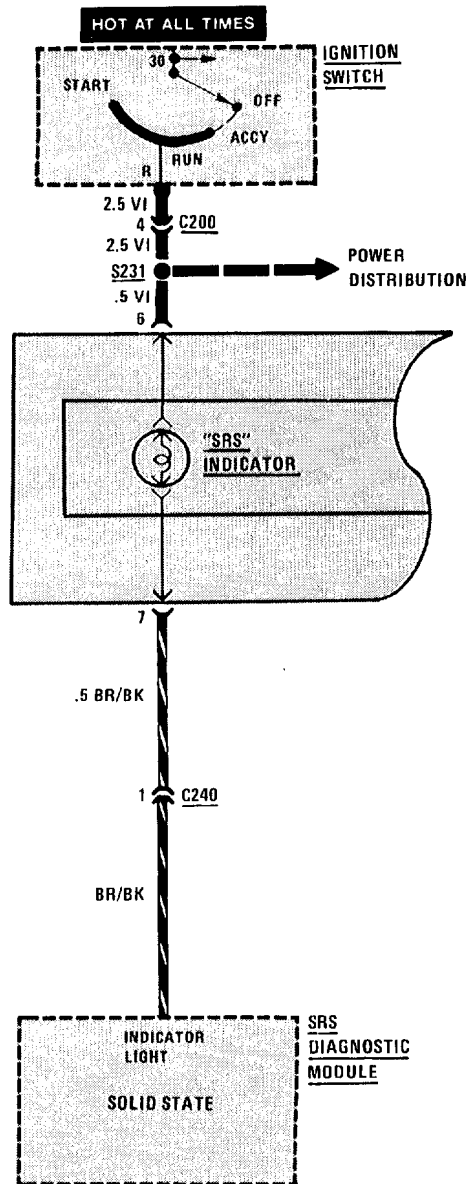

6216-2 ACTIVE CHECK CONTROL

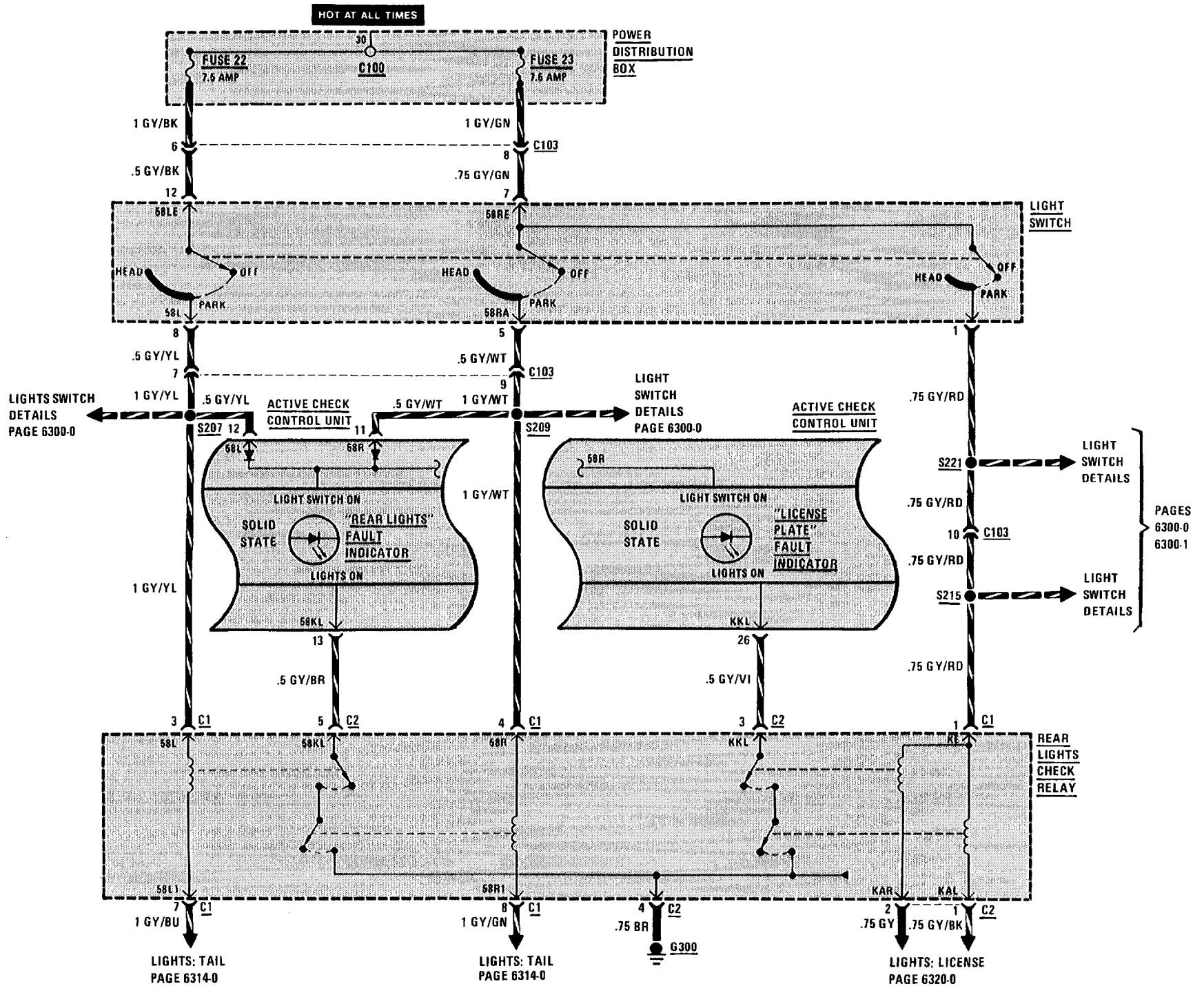

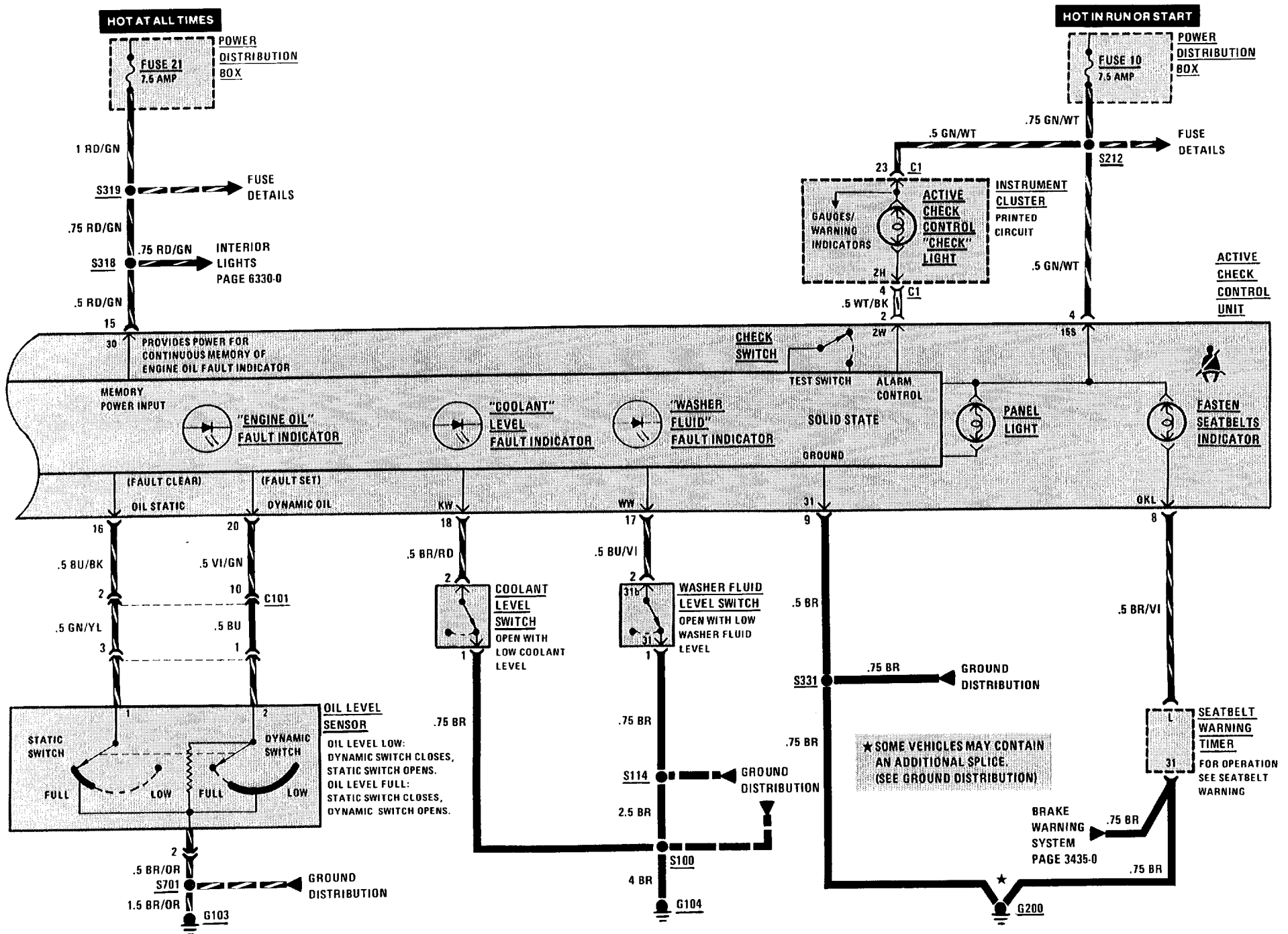

6300-0 LIGHT SWITCH DETAILS

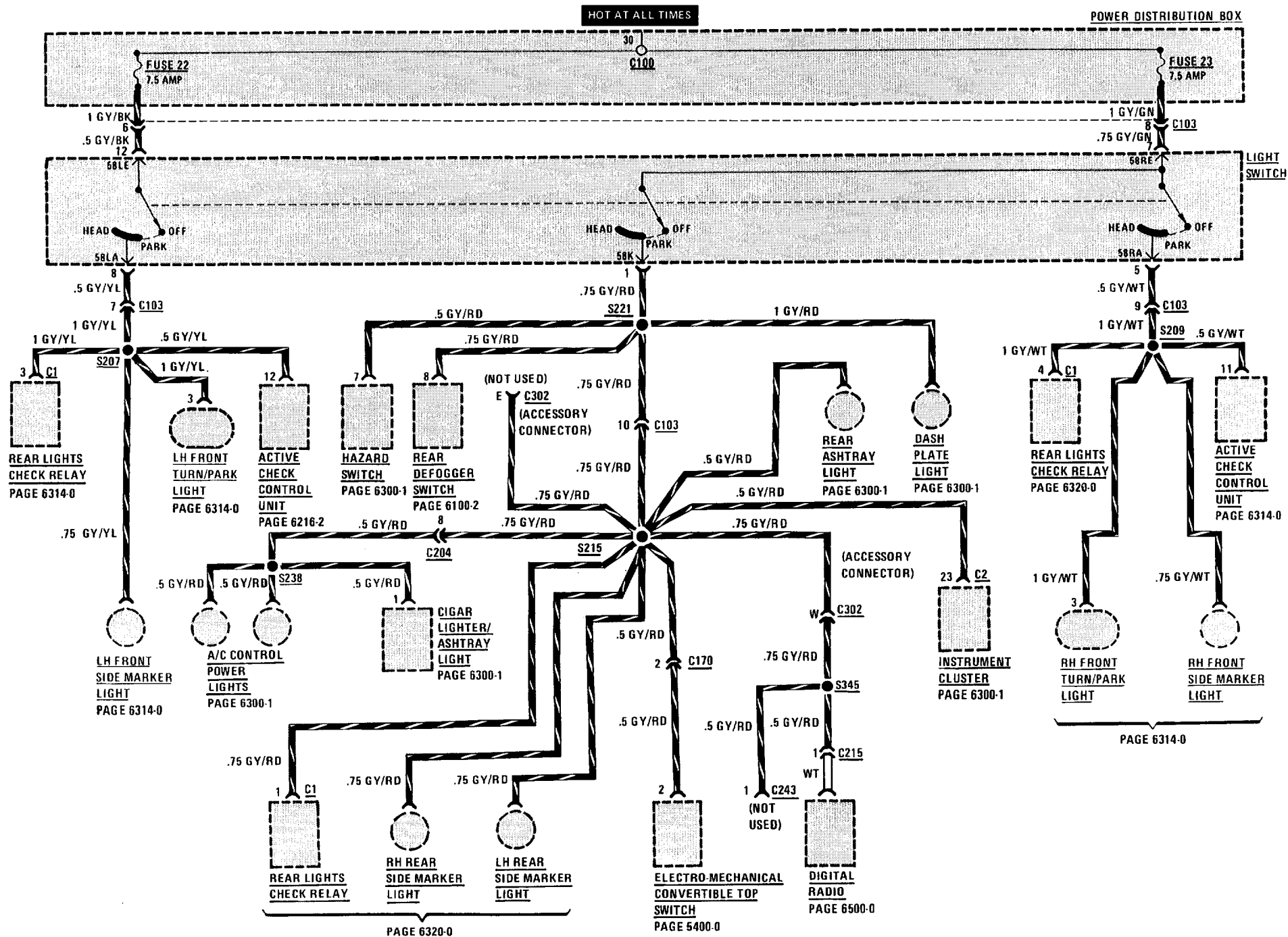

DASH LIGHTS

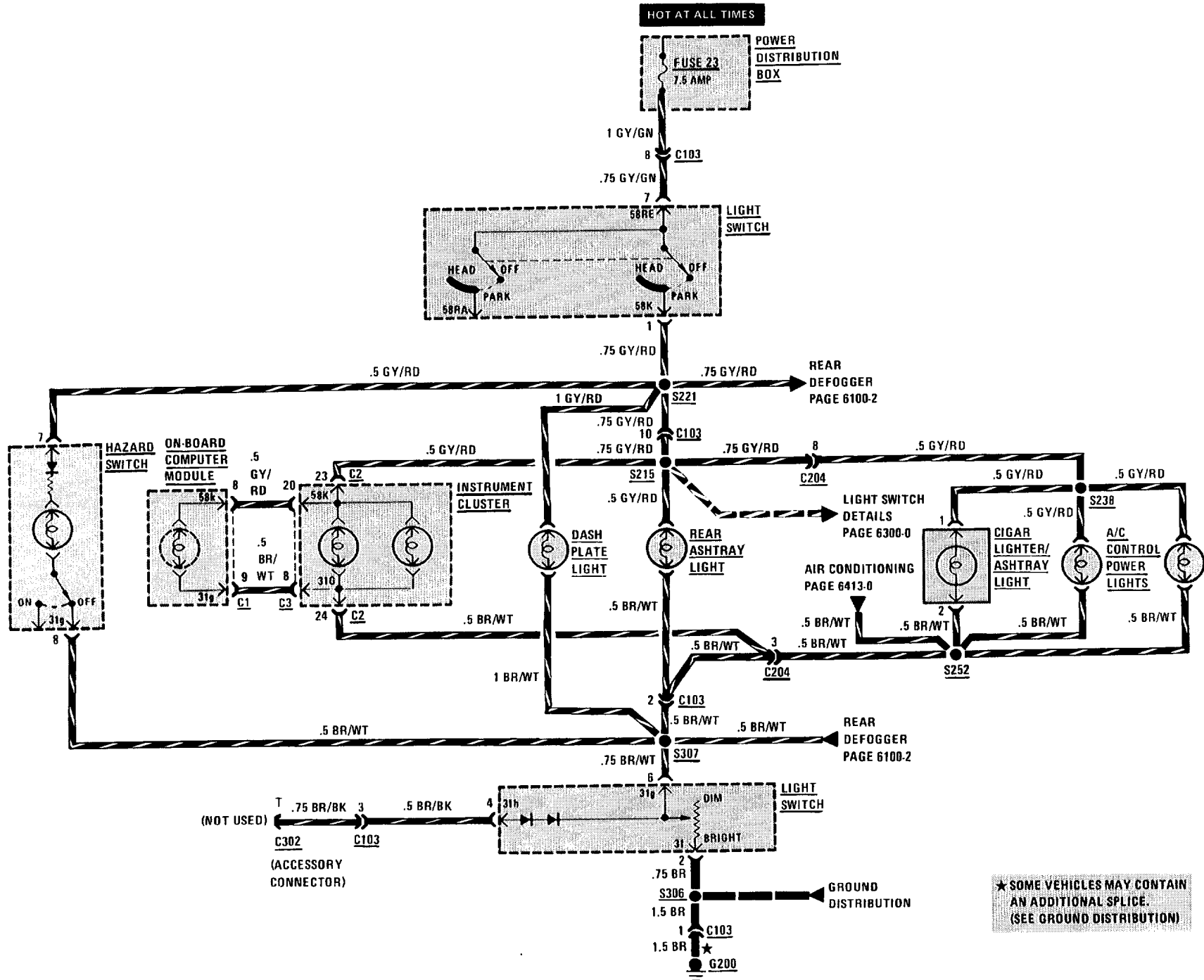

★ SOME VEHICLES MAY CONTAIN AN ADDITIONAL SPLICE. (SEE GROUND DISTRIBUTION)

6312-0 HEADLIGHTS/FOG LIGHTS

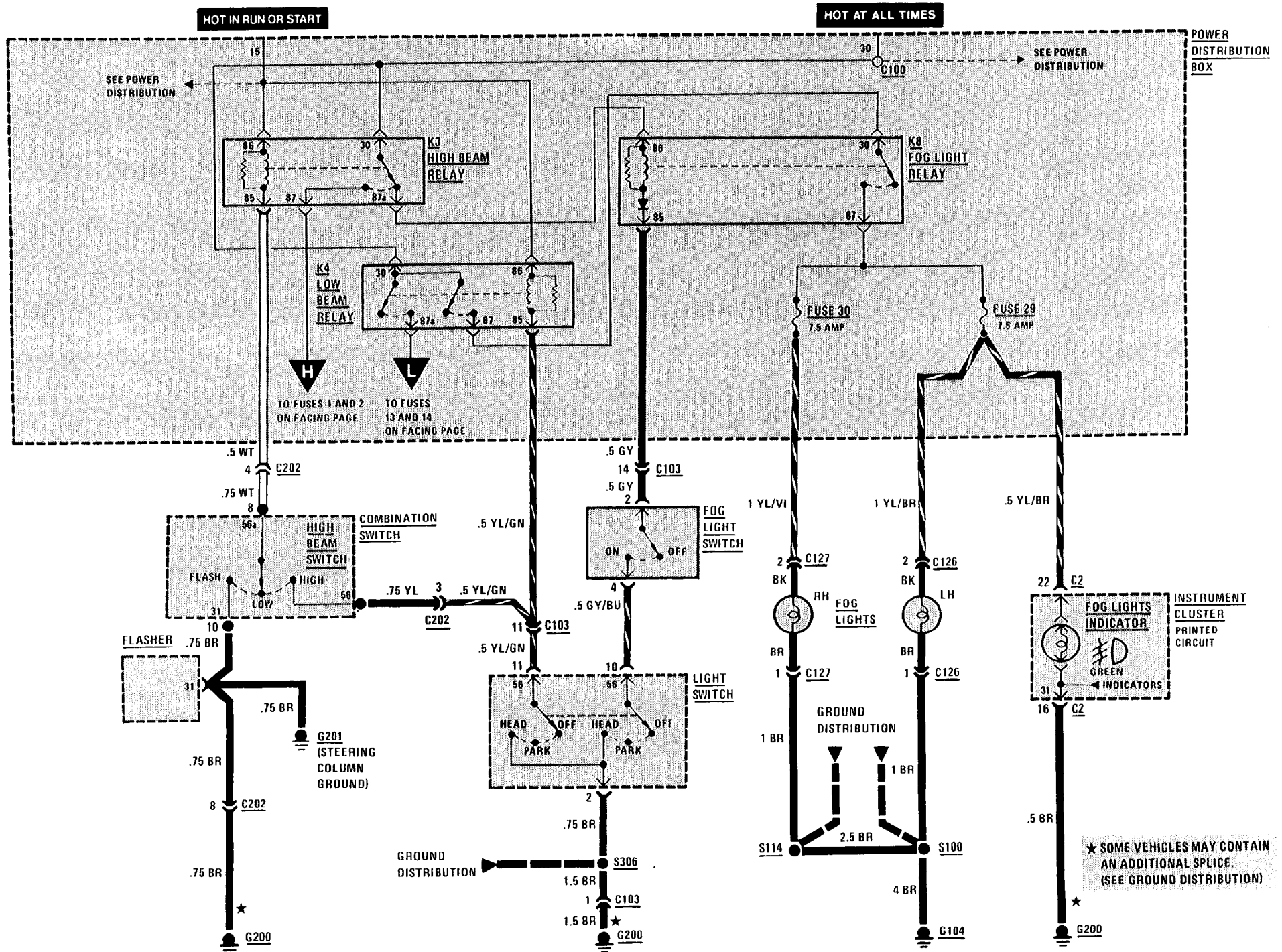

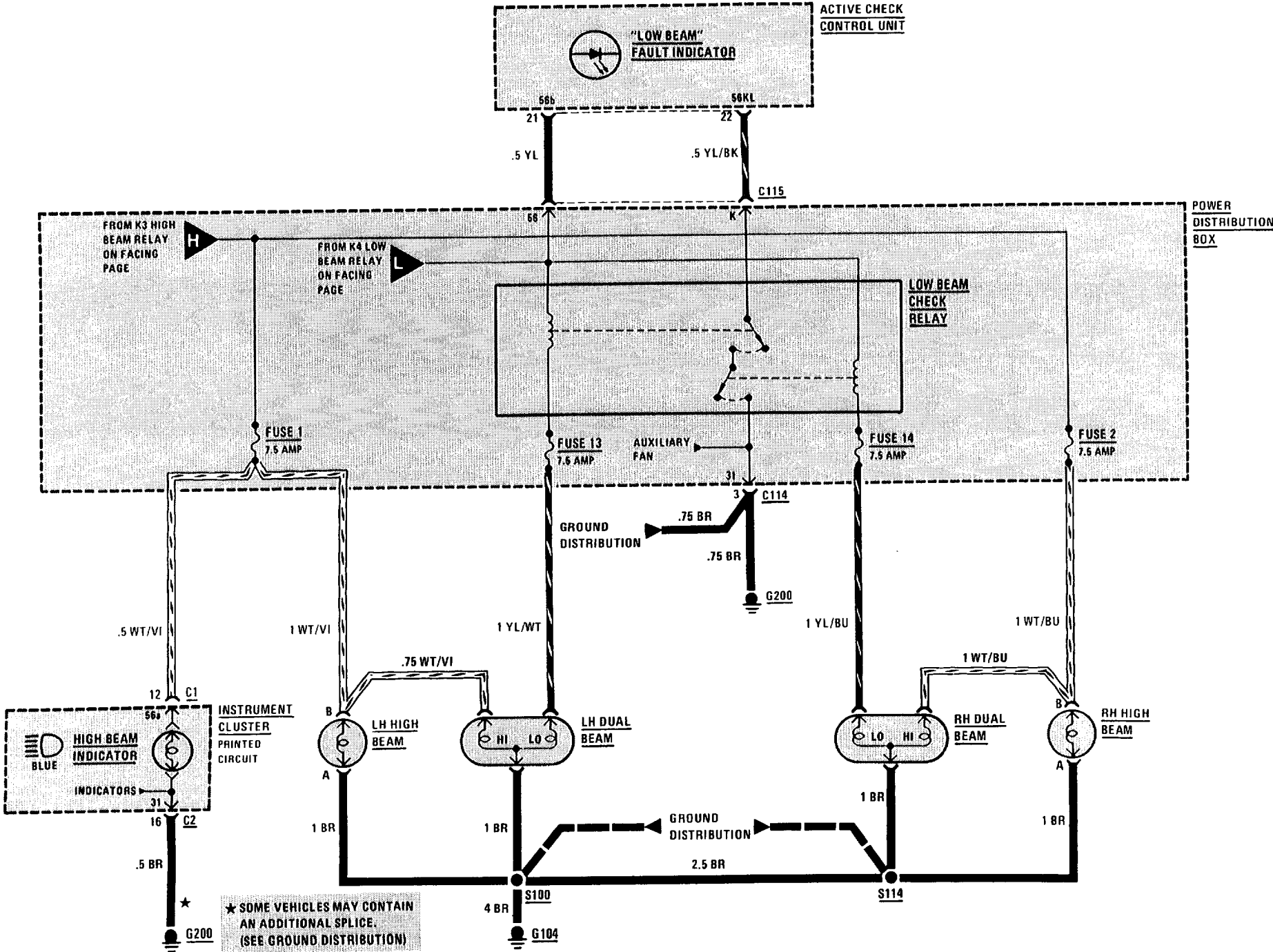

6313-0 TURN/HAZARD LIGHTS

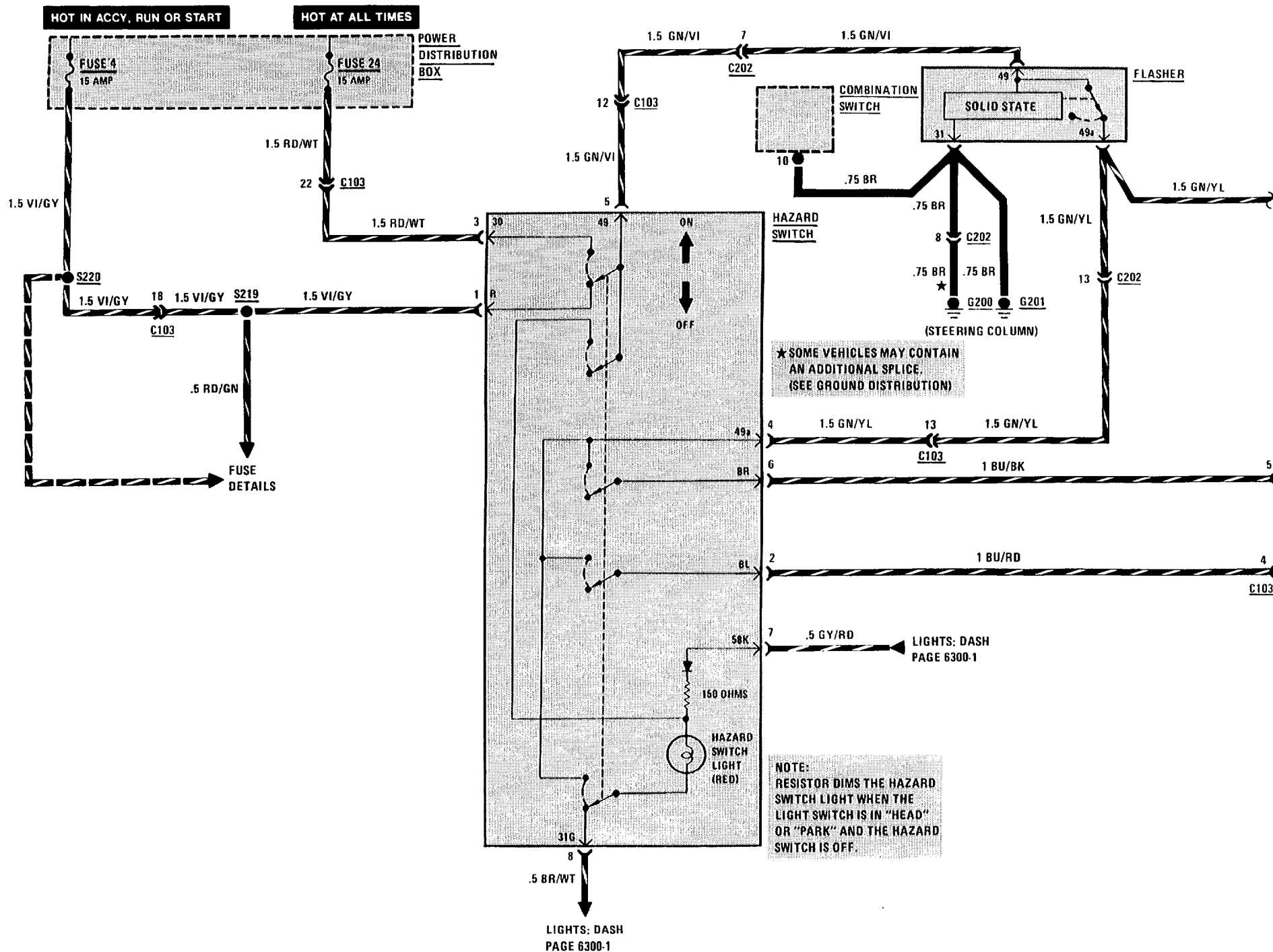

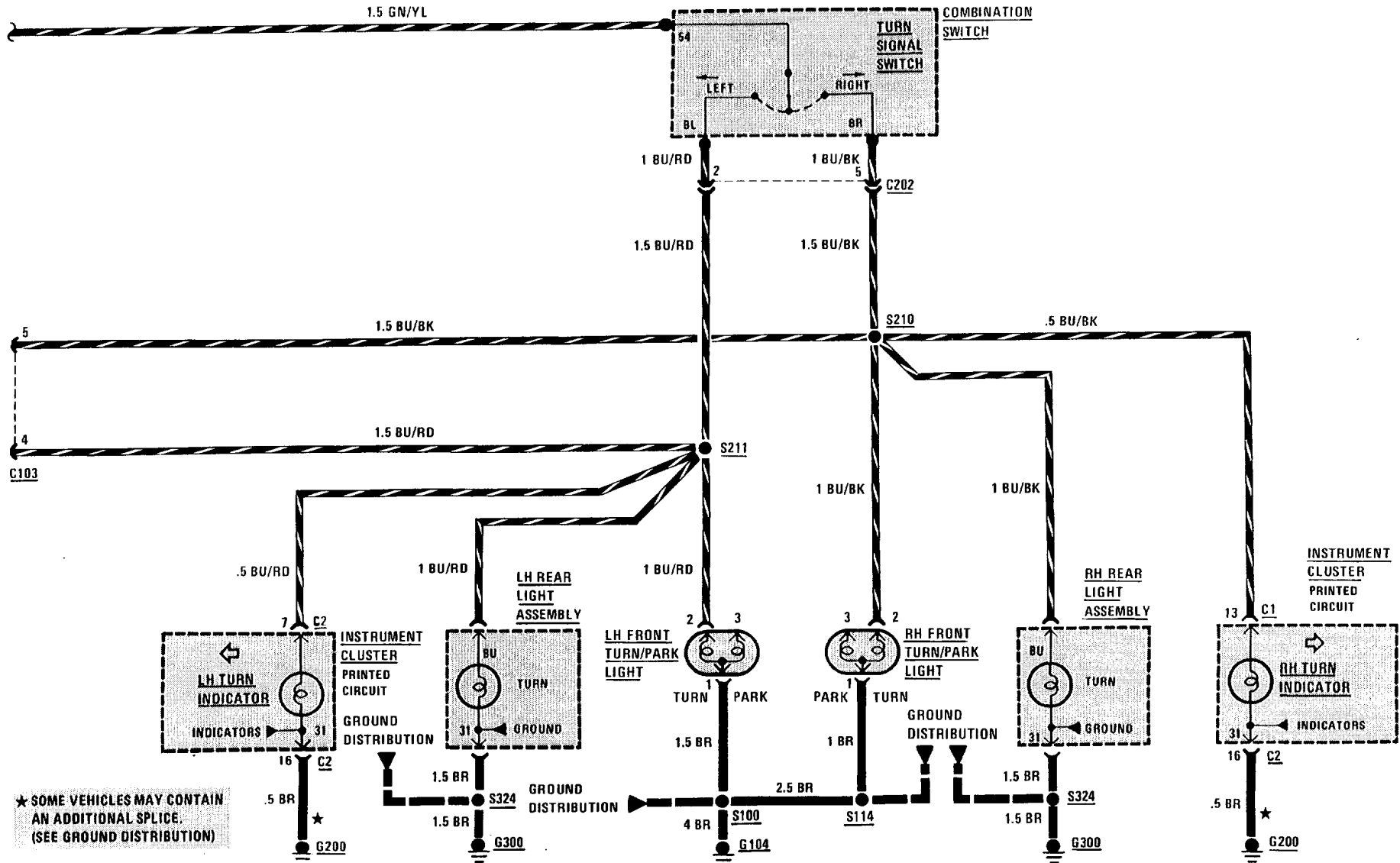

6314-0 PARK/TAIL/FRONT MARKER LIGHTS

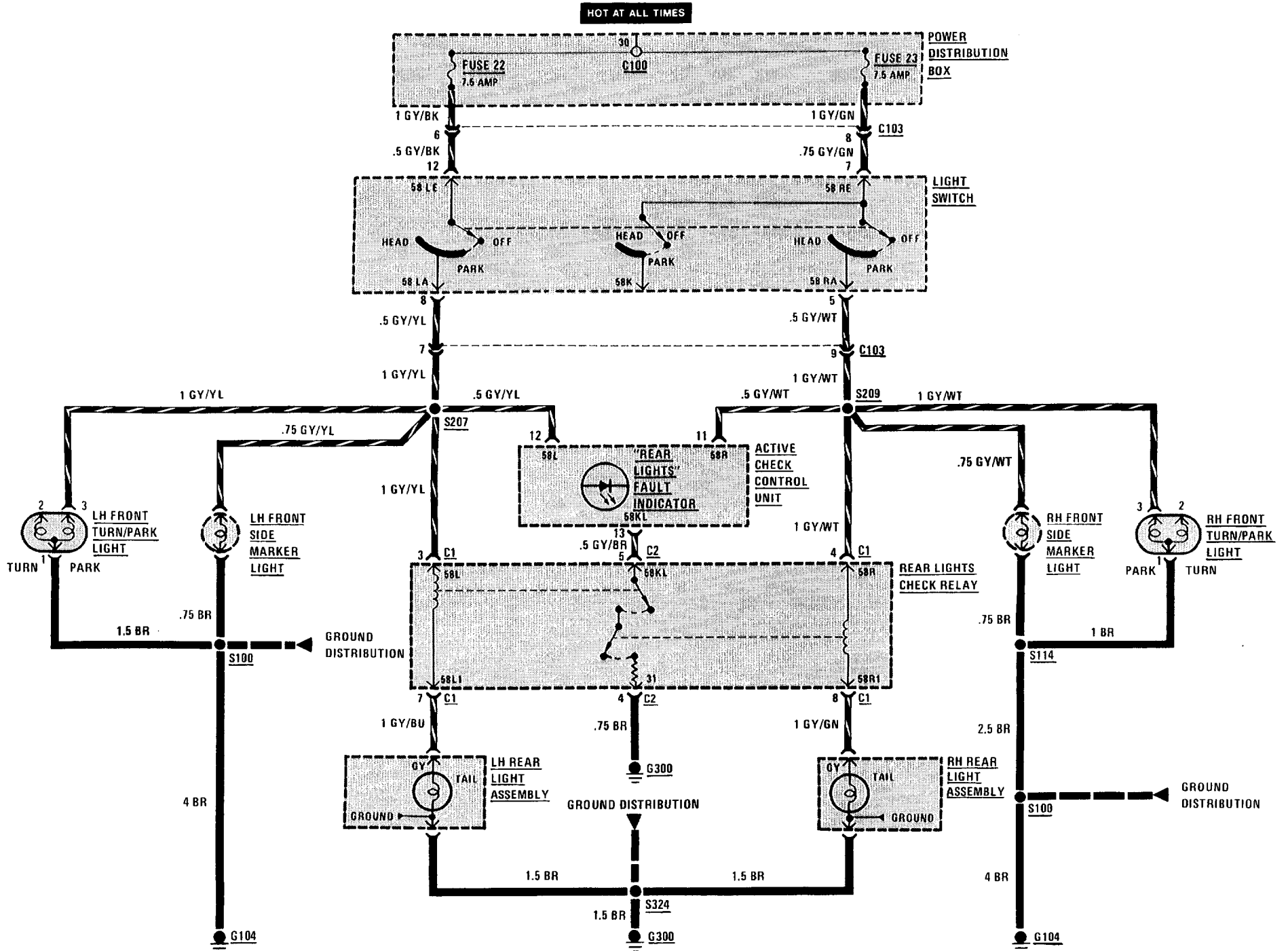

6320-0 REAR MARKER/LICENSE/TRUNK LIGHTS

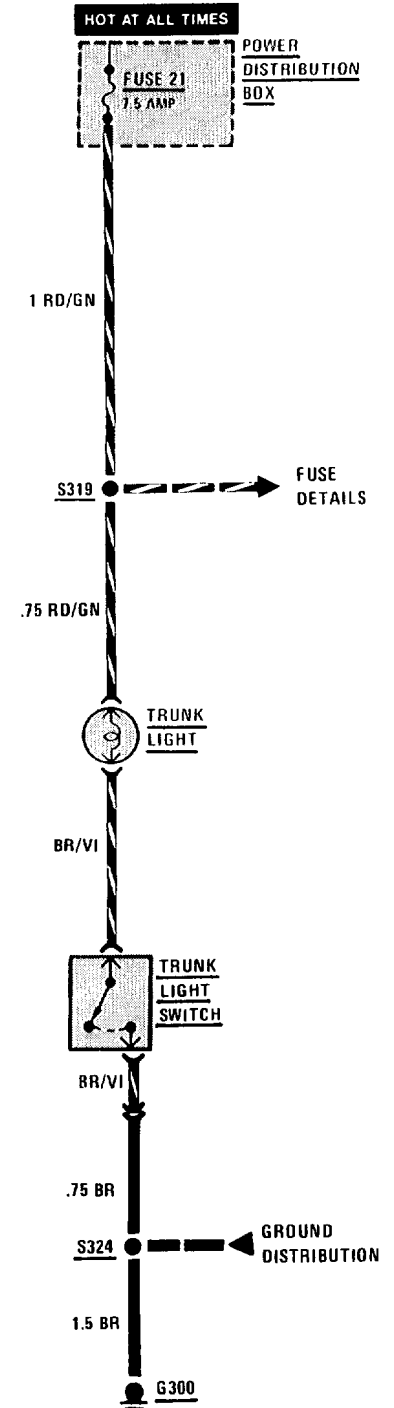
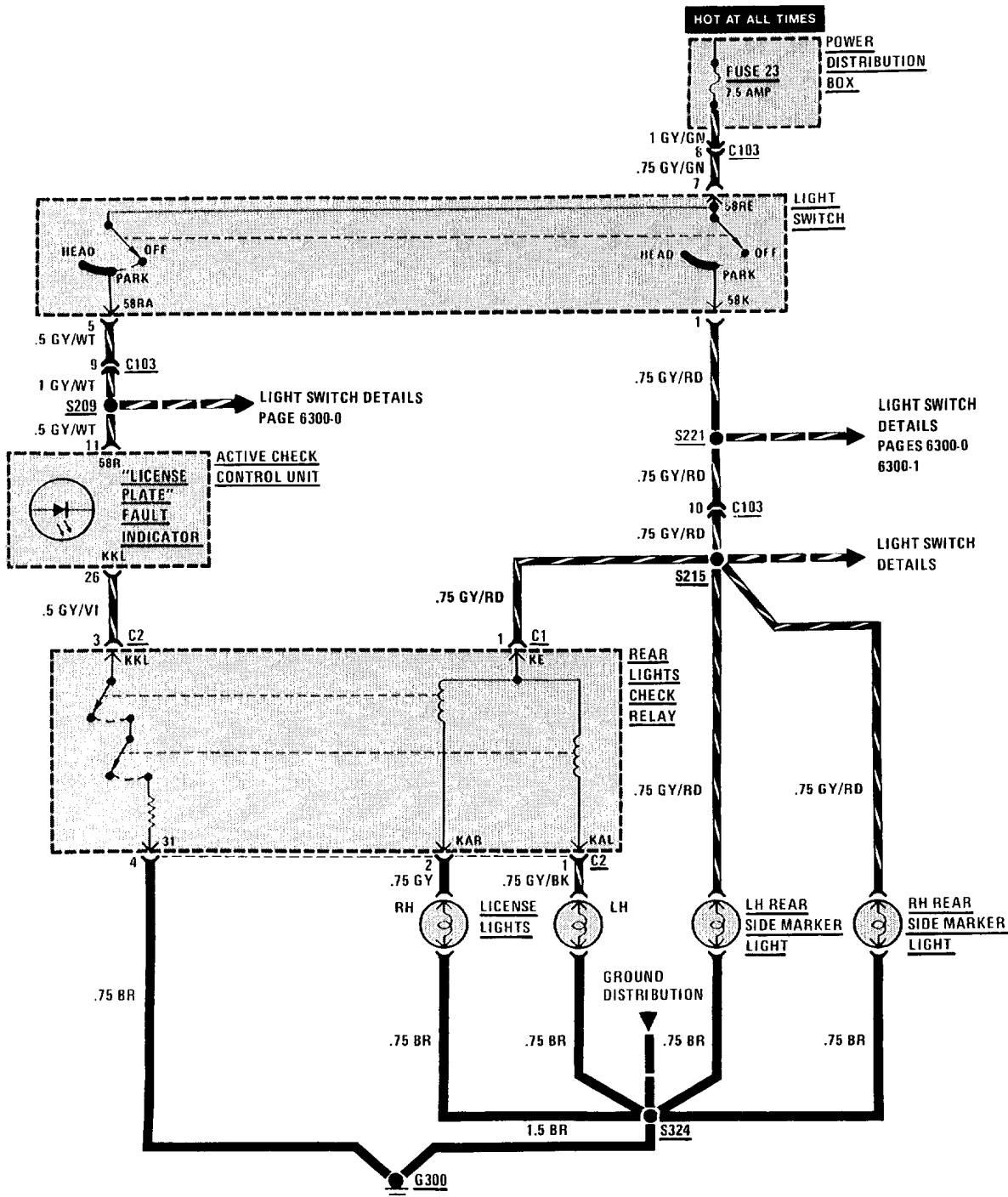

6322-0 BACK UP LIGHTS

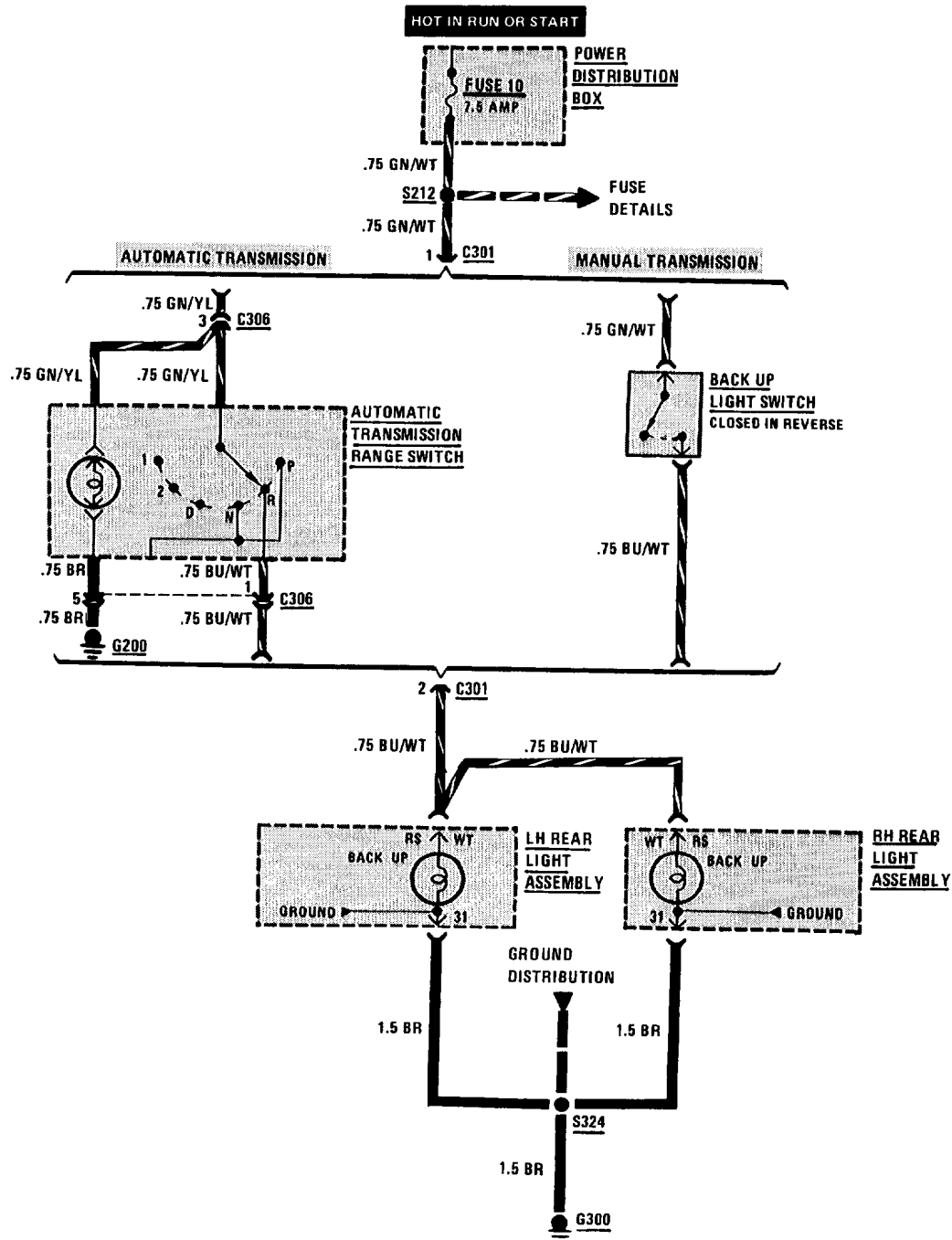

6325-0 STOP LIGHTS

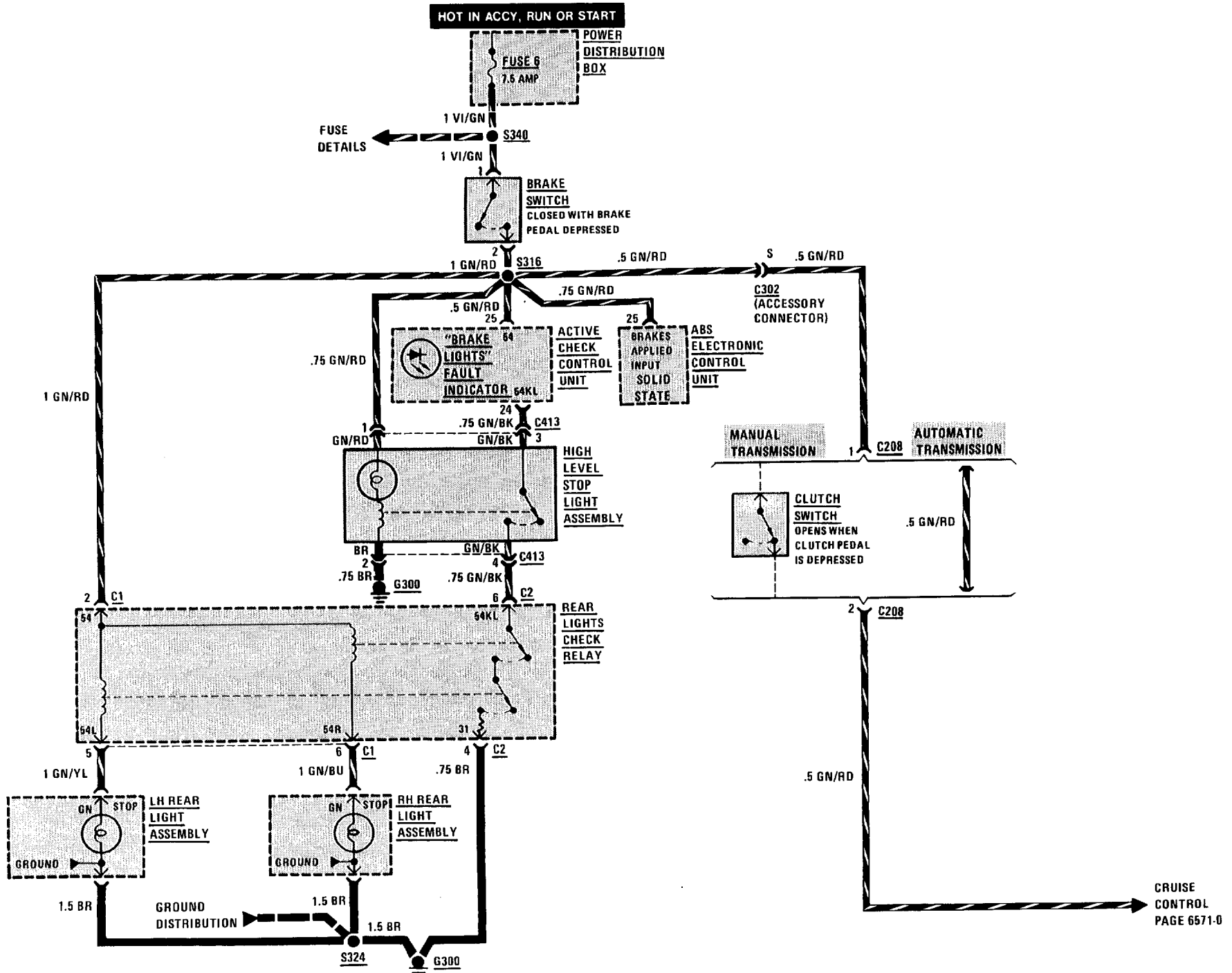

6330-0 INTERIOR LIGHTS

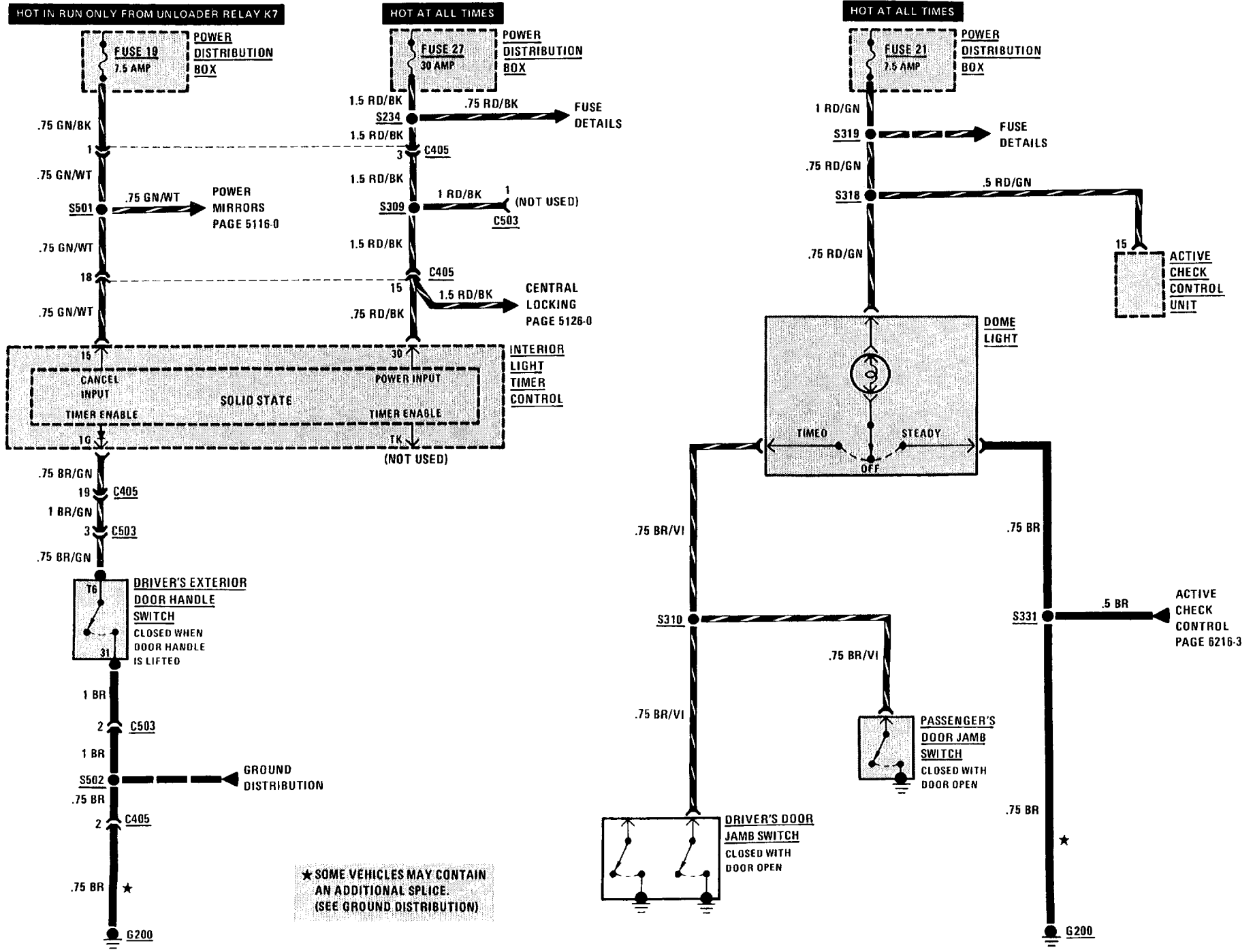

6410-0 HEATING AND AIR CONDITIONING

SYSTEM CHECK

This procedure provides an overall check of the Heating and Air Conditioning System. Each of the steps can be performed without disassembly or the use of tools.

Complete this procedure with the temperature outside the car above 60 degrees F (16 degrees C) and the engine warm and running at idle.

SYSTEM CHECK TABLE

SET: Temperature Control fully counterclockwise Upper and Lower Slide Levers to extreme left Center Slide Lever to extreme right Blower Speed Control at 0 (OFF)	
ACTION	NORMAL RESULT
Press Fresh/Recirculating Air Switch (ON). Release A/C button (OFF).	Fresh/Recirculating pushbutton lights. Blower runs slowly.
Rotate Blower Speed Control through steps 1 to 4	Blower speed increases at each step to maximum speed at Step 4
Press Fresh/Recirculating Air Switch to release it (OFF)	Fresh/Recirculating button is no longer lit. Outside air is drawn into car. (The sound of Flap Door Motors may be heard repositioning flaps.)
Rotate Temperature Control at least 1/4 turn clockwise	Air flow becomes warm
Depress A/C button (ON)	A/C button lights. A/C Compressor runs. Auxiliary Cooling Fan runs.
Press A/C button to release it (OFF)	A/C button is no longer lit. A/C Compressor turns off. Auxiliary Cooling Fan turns off.
Set Blower Speed Control to 0 (OFF)	Blower turns off

6411-0 A/C TEMPERATURE CONTROL

HEATING AND AIR CONDITIONING (HOT WATER CONTROL)

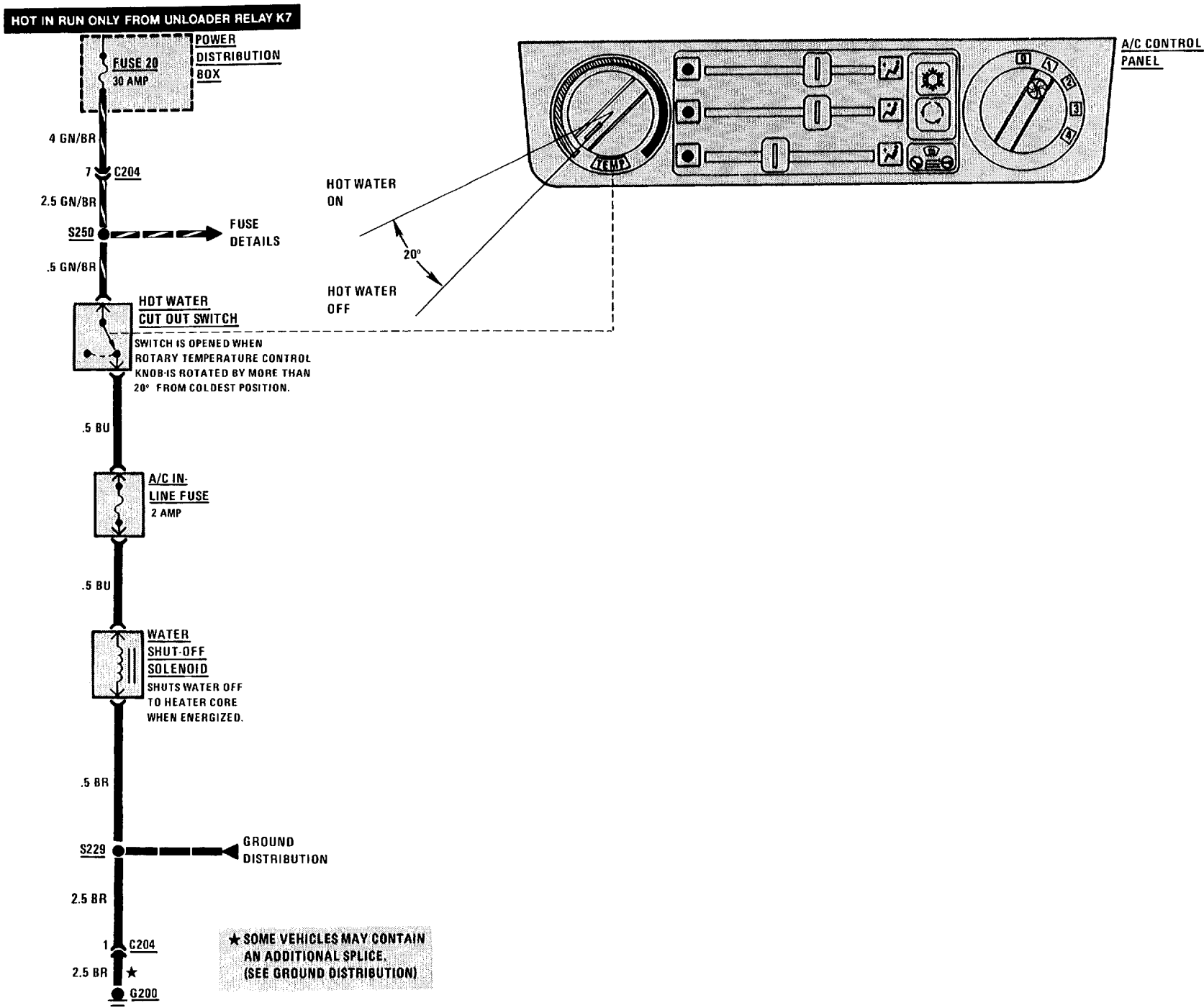

CIRCUIT OPERATION

The Water Shut-Off Solenoid controls the flow of engine coolant through the heater core. When the solenoid is energized, coolant flow is shut off to allow maximum cooling from the air conditioning system. The Water Shut-Off Solenoid is controlled by the Hot Water Cut-Off Switch, which is part of the A/C Control Panel TEMP Control.

Battery voltage is applied through Fuse 20 to the Hot Water Cut-Off Switch when the Ignition Switch is in RUN. The Hot Water Cut-Off Switch is closed when the TEMP Control is rotated fully counterclockwise (coldest position), and opens when the control is rotated more than 20 degrees in a clockwise direction. When the switch is closed, battery voltage is applied through the A/C In-Line Fuse to the Water Shut-Off Solenoid. The solenoid is energized and shuts off the coolant flow through the heater core.

The Water Shut-Off Solenoid and A/C In-Line Diode are protected by the A/C In-Line Fuse. If any failures occur in the solenoid, the fuse will isolate them to prevent the failures from affecting other parts of the heating and air conditioning circuits.

TROUBLESHOOTING HINTS

- Try the following checks before doing the System Diagnosis.
- 1. Check that Water Shut-Off Solenoid connector is firmly seated.
- 2. Check the A/C In-Line Fuse.
- Go to Heating and Air Conditioning (6410-0) System Check for a guide to normal operation.
- Go to System Diagnosis for diagnostic tests.

SYSTEM DIAGNOSIS

- Do the following test if the Water Shut-Off Solenoid does not operate normally.

WATER SHUT-OFF SOLENOID TEST (TABLE 1)

Measure: VOLTAGE At: WATER SHUT-OFF SOLENOID CONNECTOR (Disconnected) Conditions: <ul style="list-style-type: none"> • Ignition Switch: RUN • A/C Control Panel TEMP Control: FULLY COUNTERCLOCKWISE 		
Measure Between	Correct Voltage	For Diagnosis
BU & Ground	Battery	See 1
BU & or BR	Battery	See 2
<ul style="list-style-type: none"> • Rotate A/C Control Panel TEMP Control to Mid-Position 		
BU & Ground	0 Volts	See 3

(Continued in next column)

(Continued from previous column)

- If all voltages are correct, replace the Water Shut-Off Solenoid.
- 1. Check the BU wire and A/C In-Line Fuse for an open. If wire and fuse are good, go to Table 2.
- 2. Check the BR wire for an open to ground. Check that connector C204 is properly mated.
- 3. Check BU wire for a wire-to-wire short to voltage. If wire is good, replace the A/C Control Panel TEMP Control.

WATER SHUT-OFF SOLENOID TEST (TABLE 2)

Measure: VOLTAGE At: HOT WATER CUT-OFF SWITCH CONNECTOR (Disconnected) Conditions: <ul style="list-style-type: none"> • Ignition Switch: RUN • Water Shut-Off Solenoid: CONNECTED 		
Measure Between	Correct Voltage	For Diagnosis
GN/BR & Ground	Battery	See 1
GN/BR & BU	Battery	See 2
<ul style="list-style-type: none"> • If both voltages are correct, replace the A/C Control Panel TEMP Control. 1. Check the GN/BR wire for an open back to Fuse 20. 2. Check the BU wire for an open. 		

HEATING AND AIR CONDITIONING (BLOWER CONTROLS)

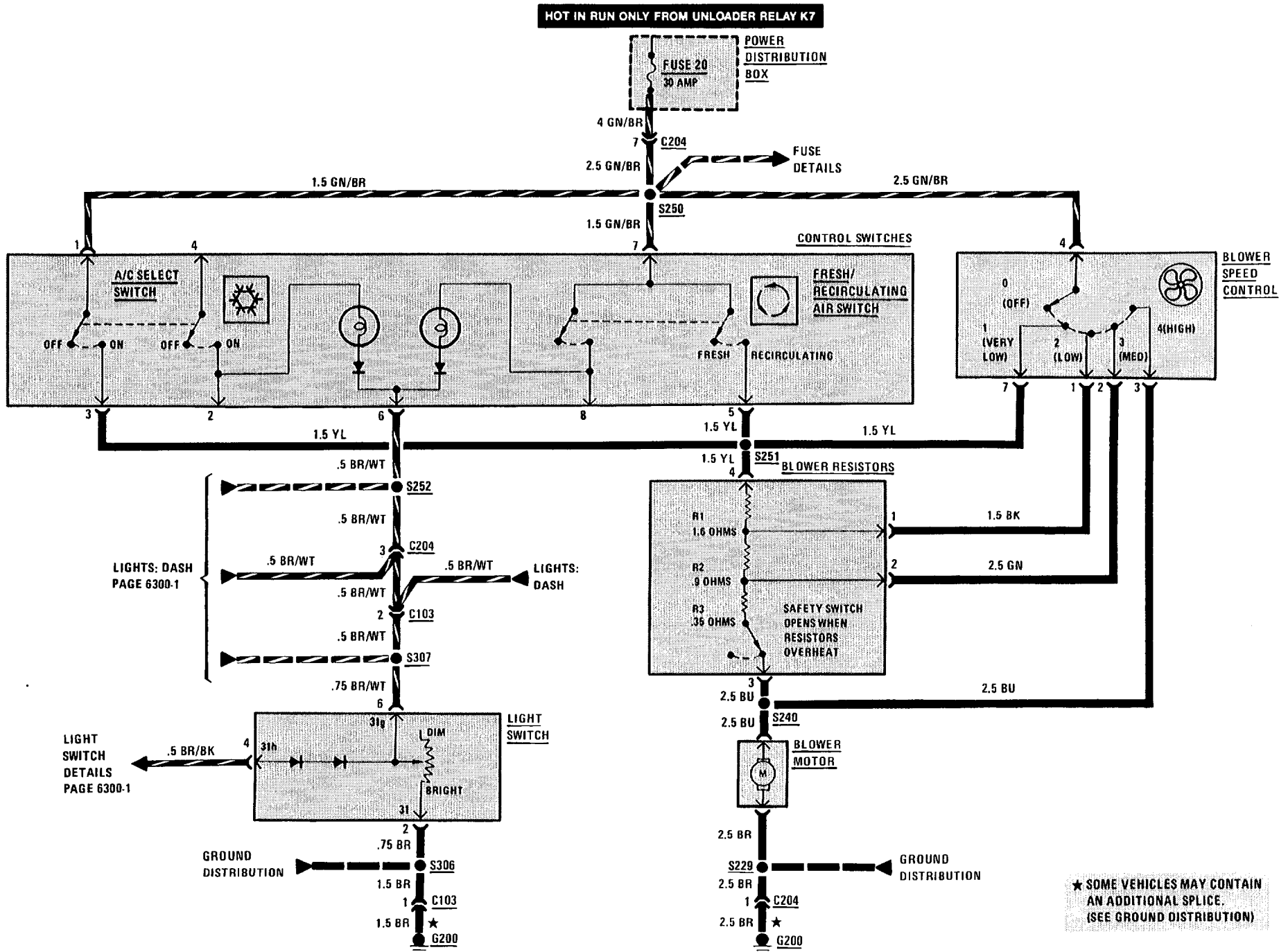

CIRCUIT OPERATION

With the Ignition Switch in RUN, battery voltage is applied to the Control Switches and the Blower Speed Control through the GN/BR wires. If either the A/C Select Switch or the Fresh/Recirculating Air Switch are ON or the Blower Speed Control is in position 1, battery voltage is applied through the YL wire to the Blower Resistors and the Blower Motor.

The Blower Motor is a variable speed motor which runs at a speed proportional to the voltage applied to it. With all of the Blower Resistors in the circuit, the voltage applied to the motor is reduced so the motor runs at a low speed.

As the Blower Speed Control is moved through positions 2 and 3, some of the resistors are bypassed, allowing more voltage to be applied to the Blower Motor, which then runs at a higher speed. When the Blower Speed Control is moved to position 4, battery voltage is applied directly to the Blower Motor, which then runs at maximum speed.

The Blower Resistors dissipate heat because of the current flowing through them. They are cooled by the air flow from the blower. If there is insufficient air flow to cool the resistors, the safety switch will open, shutting the Blower Motor off until the resistors have cooled.

TROUBLESHOOTING HINTS

- Try the following checks before doing the System Diagnosis.
- 1. Check Fuse 20 by visual inspection.
- 2. If Blower will run in high only, check the Blower Resistors' Safety Switch for an open.

- Go to Heating and Air Conditioning (6410-0) System Check for a guide to normal operation.
- Go to System Diagnosis for diagnostic tests.

SYSTEM DIAGNOSIS

- Do the tests listed for your symptom in the Symptom Table below.
- Tests follow the Symptom Table.

SYMPTOM TABLE

SYMPTOM	DO TEST
Blower Motor does not run in any speed setting	B
Blower runs only in HIGH (does not run in any other speed setting)	B
Blower does not run in some modes	A
Blower does not run with A/C ON or in Recirculating mode	A
A/C Select Switch or Fresh/Recirculating Air Switch does not light	A

A: CONTROL SWITCH VOLTAGE TEST

Measure: VOLTAGE		
At: CONTROL SWITCHES CONNECTOR (Disconnected)		
Conditions:		
<ul style="list-style-type: none"> • Ignition Switch: RUN • Blower Speed Control: OFF 		
Measure Between	Correct Voltage	For Diagnosis
1 (GN/BR) & Ground	Battery	See 1
1 (GN/BR) & 3 (YL)	Battery	See 2 & 4
7 (GN/BR) & Ground	Battery	See 1
7 (GN/BR) & 5 (YL)	Battery	See 2 & 4
7 (GN/BR) & 6 (BR/WT)	Battery	See 3
<ul style="list-style-type: none"> • If all voltages are correct, do Test B. 1. Check the GN/BR wire for an open. 2. Check the YL wire for an open. 3. Check the BR/WT wire for an open. 4. If voltage is not present between the GN/BR wire and both the YL wires (terminals 3 and 5), do Test B. 		

6413-2 A/C BLOWER CONTROLS

B: BLOWER SPEED CONTROL TEST

Measure: VOLTAGE AT: BLOWER SPEED CONTROL CONNECTOR (Disconnected) Conditions: <ul style="list-style-type: none"> • Ignition Switch: RUN • A/C Select Switch: ON (Depressed) • Fresh/Recirculating Air Switch: FRESH (Not Depressed) 		
Measure Between	Correct Voltage	For Diagnosis
4 (GN/BR) & Ground	Battery	See 1
7 (YL) & Ground	Battery	See 2
• A/C Select Switch: OFF (Not Depressed)		
7 (YL) & Ground	0 Volts	See 3
4 (GN/BR) & 7 (YL)	Battery	See 4, 8, 9, & 10
4 (GN/BR) & 1 (BK)	Battery	See 5, 8, 9, & 10
4 (GN/BR) & 2 (GN)	Battery	See 6, 8, 9, & 10
4 (GN/BR) & 3 (BU)	Battery	See 7 & 10
<ul style="list-style-type: none"> • If all voltages are correct, replace the Blower Motor. <ol style="list-style-type: none"> 1. Check the GN/BR wire for an open. 2. Check the YL wire for an open between Blower Speed Control and splice S231. 3. Check the YL wire for a wire to wire short to voltage. 		

(Continued in next column)

(Continued from previous column)

<ol style="list-style-type: none"> 4. Check the YL wire for an open between splice S231 and the Blower Resistors. 5. Check the BK wire for an open. 6. Check the GN wire for an open. 7. Check the BU wire for an open. 8. If voltage is not present at the YL wire, but is present at the GN wire or BK wire, replace the Blower Resistors. 9. If voltage is not present at the YL, BK or GN wires, check for an open Blower Resistors' Safety Switch. 10. If voltage is not present at the YL, BK, GN and BU wires, do Test C.

C: BLOWER MOTOR TEST

Measure: VOLTAGE At: BLOWER MOTOR CONNECTOR (Disconnected) Conditions: <ul style="list-style-type: none"> • Ignition Switch: RUN • A/C Select Switch: ON • Blower Speed Control: HIGH 		
Measure Between	Correct Voltage	For Diagnosis
BU & Ground	Battery	See 1
BU & BR	Battery	See 2
<ul style="list-style-type: none"> • If both voltages are correct, replace the Blower Motor. <ol style="list-style-type: none"> 1. Check the BU wire for an open. If wire is good, recheck Test B. 2. Check the BR wire to ground G200 for an open. 		

6421-0 A/C AIR DELIVERY CONTROL

HEATING AND AIR CONDITIONING (FRESH/RECIRCULATING AIR CONTROLS)

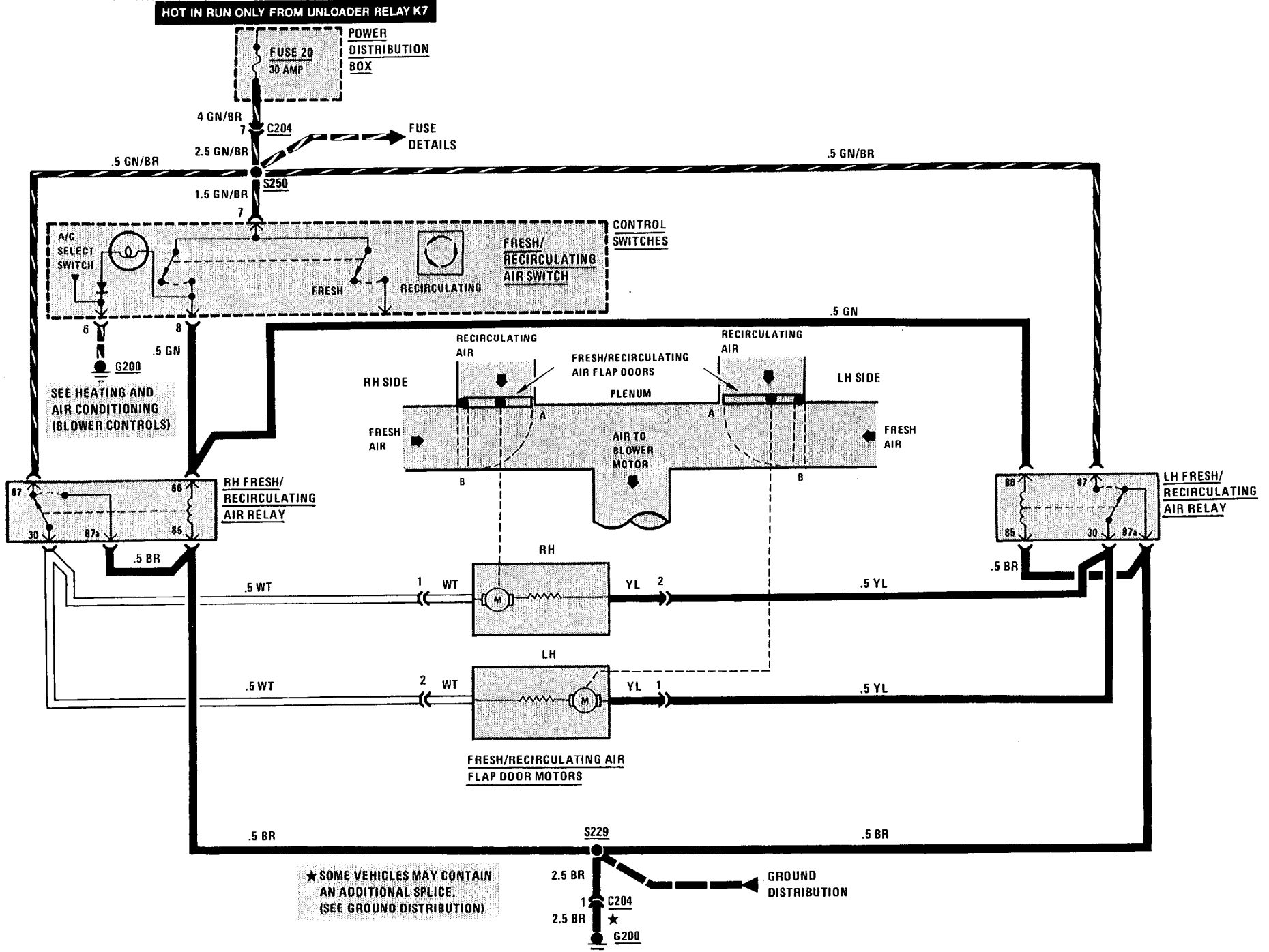

CIRCUIT OPERATION

When the Ignition Switch is in RUN, battery voltage is applied to terminal 7 of the Control Switches, the normally open contacts of the LH Fresh/Recirculating Air Relay, and the normally closed contacts of the RH Fresh/Recirculating Air Relay. If the Fresh/Recirculating Air Switch is not depressed (open), battery voltage is applied through the normally closed contacts of the RH Fresh/Recirculating Air Relay to both Fresh/Recirculating Air Flap Door Motors and then to ground through the normally closed contacts of the LH Fresh/Recirculating Air Relay. Both motors operate and move the Fresh/Recirculating Air Flap Doors to position A, allowing fresh air to enter the blower.

When the Fresh/Recirculating Air Switch is depressed (closed), battery voltage is applied through the switch to both the LH and RH Fresh/Recirculating Air Relay coils. Both relays are energized. Battery voltage is then applied through the closed contacts of the LH Fresh/Recirculating Air Relay to the Flap Door Motors, and to ground through the closed contacts of the RH Fresh/Recirculating Air Relay. Since the voltage is now applied to the Flap Door Motors in the opposite direction, the motors reverse direction and move the Fresh/Recirculating Air Flap Doors to position B, allowing only recirculating air to enter the blower. Both of the Air Flap Door Motors remain energized continuously. When the doors reach the end of their travel, the motors stall and hold the doors in position.

TROUBLESHOOTING HINTS

- Try the following checks before doing the System Diagnosis.
- 1. Check that LH and RH Fresh/Recirculating Air Relays are firmly seated.
- 2. Check that LH and RH Fresh/Recirculating Air Relay pigtail connectors are properly mated.
- Go to Heating and Air Conditioning (6410-0) System Check for a guide to normal operation.
- Go to System Diagnosis for diagnostic tests.

SYSTEM DIAGNOSIS

- Do the tests below if the Fresh/Recirculating Air Flap Doors do not operate.

A: FRESH/RECIRCULATING AIR FLAP DOOR MOTOR VOLTAGE TEST

Measure: VOLTAGE At: FRESH/RECIRCULATING AIR FLAP DOOR MOTOR PIGTAIL CONNECTORS (Disconnected) Conditions: <ul style="list-style-type: none"> • Ignition Switch: RUN • Fresh/Recirculating Air Switch: RELEASED (FRESH) 		
Measure Between	Correct Voltage	For Diagnosis
WT and Ground	Battery	See 1
WT and YL	Battery	See 2
• Fresh/Recirculating Air Switch: DEPRESSED (RECIRCULATING)		
YL and Ground	Battery	See 3

(Continued in next column)

(Continued from previous column)

YL and WT	Battery	See 3
• If all voltages are correct, replace the inoperative motor.		
1. Check the WT wire for an open. If wire is good, do Test B for RH Air Relay.		
2. Check the YL wire for an open. If wire is good, do Test B for LH Air Relay.		
3. Do Test B for both Air Relays.		

B: FRESH/RECIRCULATING AIR RELAY VOLTAGE TEST

Measure: VOLTAGE At: FRESH/RECIRCULATING AIR RELAY CONNECTOR (Disconnected) Conditions: <ul style="list-style-type: none"> • Ignition Switch: RUN • Fresh/Recirculating Air Switch: DEPRESSED (RECIRCULATING) • Fresh/Recirculating Air Flap Door Motor Connectors: CONNECTED 		
Measure Between	Correct Voltage	For Diagnosis
87 (GN/BR) and Ground	Battery	See 1
86 (GN) and Ground	Battery	See 2
86 (GN) and 85 (BR)	Battery	See 3
86 (GN) and 87a (BR)	Battery	See 3

(Continued on next page)

6421-2 A/C AIR DELIVERY CONTROL

(Continued from previous page)

- If all voltages are correct, replace the suspect Fresh/Recirculating Air Relay.
- 1. Check the GN/BR wire for an open.
- 2. Check the GN wire back to the Control Switches for an open. If wire is good, do Test C.
- 3. Check the BR wire for an open.

C: CONTROL SWITCHES VOLTAGE TEST

Measure: VOLTAGE At: CONTROL SWITCHES CONNECTOR (Disconnected) Condition: <ul style="list-style-type: none">• Ignition Switch: RUN		
Measure Between	Correct Voltage	For Diagnosis
7 (GN/BR) & Ground	Battery	See 1
7 (GN/BR) & 8 (GN)	Battery	See 2
<ul style="list-style-type: none">• If both voltages are correct, replace the Control Switches.1. Check the GN/BR wire for an open. If wire is good, check that connector C204 is properly mated.2. Check the GN wire for an open between the Control Switches and the LH and RH Fresh/Recirculating Air Relays.		

6452-0 A/C COMPRESSOR CONTROLS

HEATING AND AIR CONDITIONING (COMPRESSOR CONTROLS)

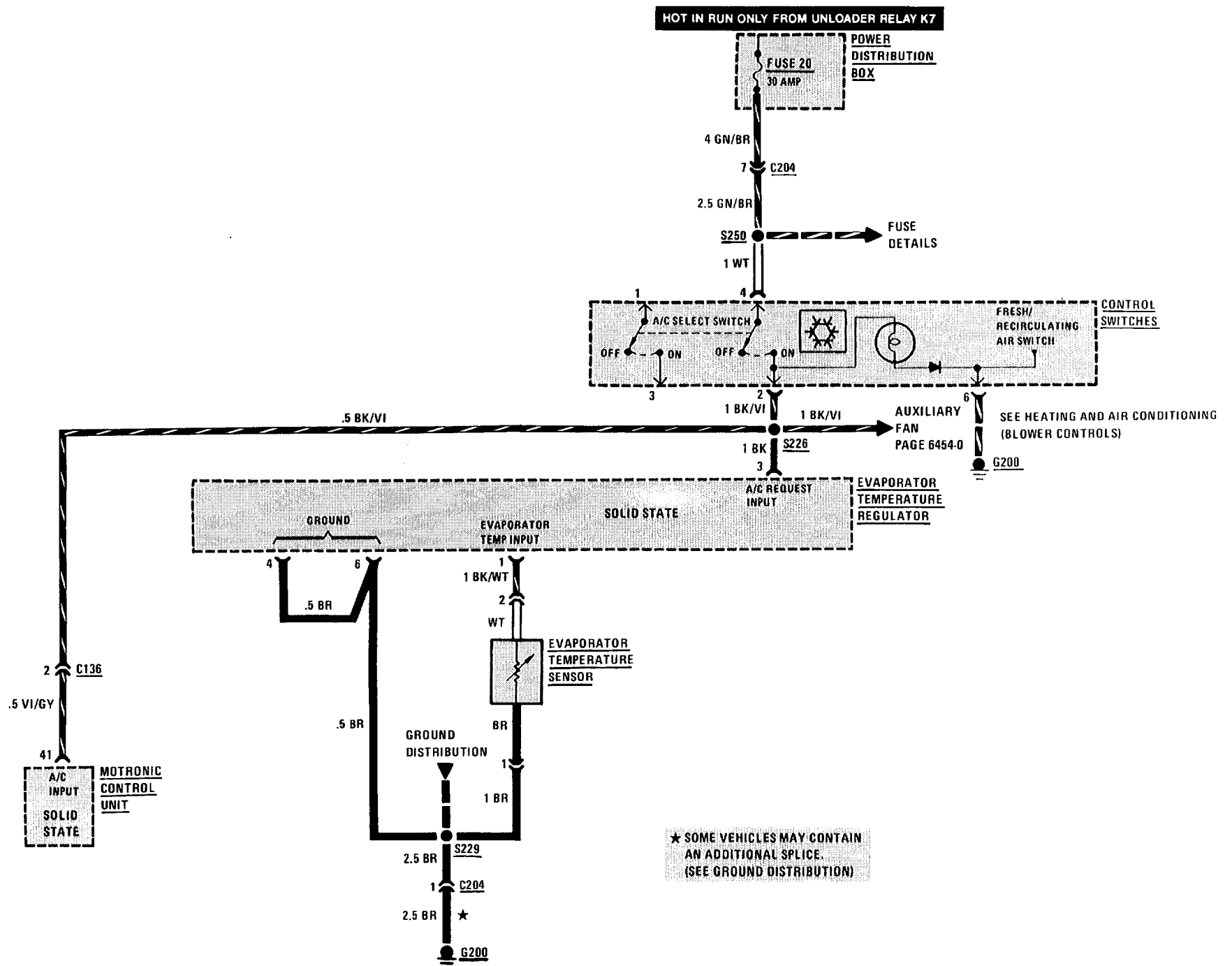

HEATING AND AIR CONDITIONING (COMPRESSOR CONTROLS)

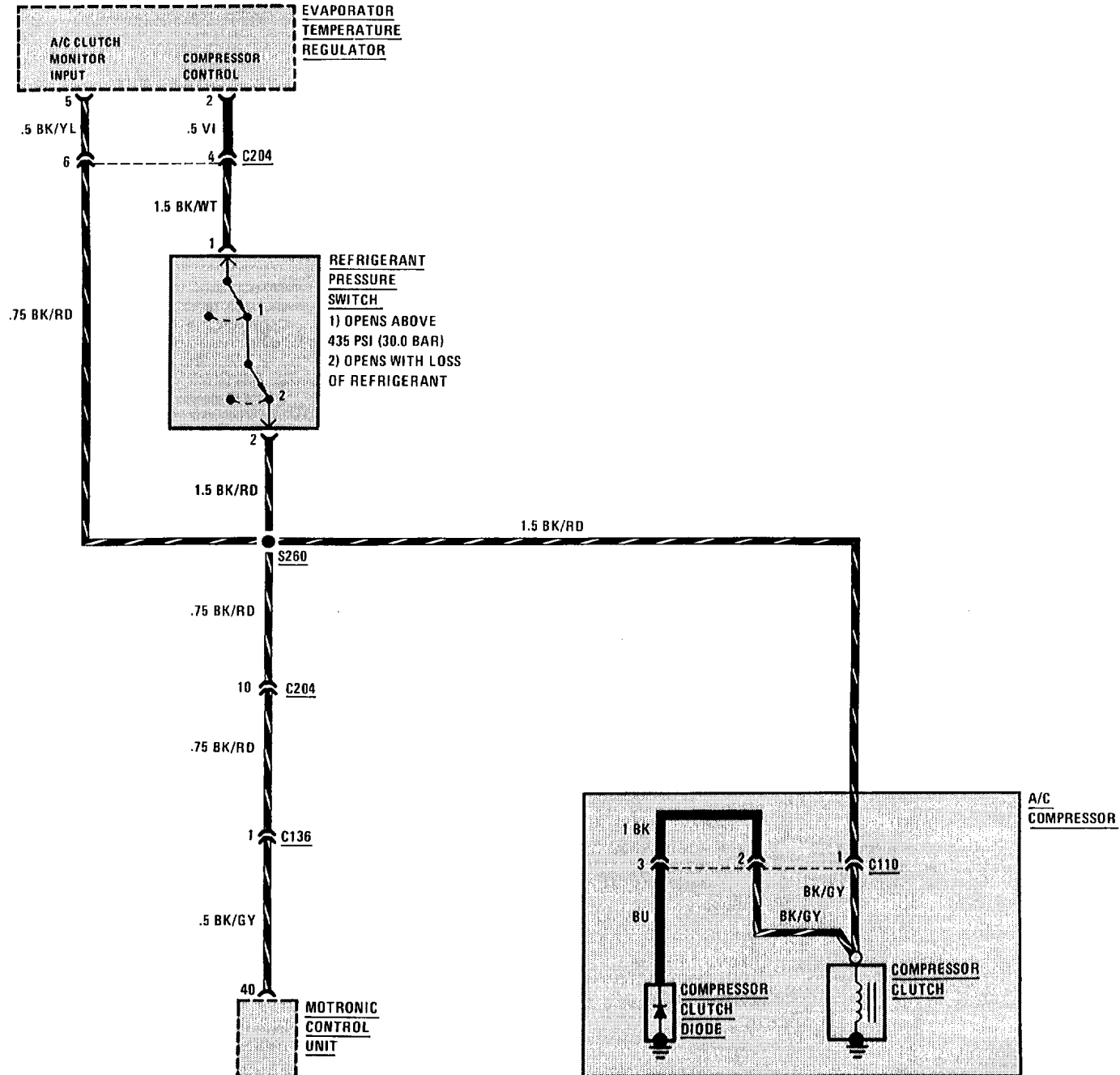

CIRCUIT OPERATION

When the Ignition Switch is in RUN, battery voltage is applied through Fuse 20 to the A/C Select Switch. When the A/C Select Switch is pressed voltage is applied to terminal 3 of the Evaporator Temperature Regulator. The Evaporator Temperature Regulator applies voltage from terminal 2 to the Compressor Clutch through the Refrigerant Pressure Switch.

The Refrigerant Pressure Switch will disengage the Compressor Clutch when refrigerant pressure rises above 435 PSI (30.0 Bar), or when a loss of refrigerant brings the pressure below 21 PSI (1.5 Bar). The Evaporator Temperature Regulator will detect the High Pressure Cut-Out Switch opening at terminal 5 and will turn off the output voltage at the Compressor Control terminal. The Evaporator Temperature Regulator will not allow the Compressor Clutch to be turned on again until circuit continuity has been restored between terminals 5 and 2. The Evaporator Temperature Regulator tests for continuity by momentarily applying voltage at the Compressor Control every 8 to 10 seconds. Voltage at the A/C Clutch Monitor Input indicates continuity. The Evaporator Temperature Regulator will continue to apply voltage at the on Compressor Control output, which will energize the Compressor Clutch.

Clutch Diode

Whenever the Compressor Clutch is de-energized, the collapsing magnetic field induces a voltage in the winding. The Clutch Diode provides a path for the resulting current.

A/C On Input

When the Compressor Clutch is turned on, voltage is applied to terminal 29 of the Motronic Control Unit. The Motronic Control Unit uses this signal increase idle speed to compensate for the increased engine load from the Compressor Clutch engaging.

TROUBLESHOOTING HINTS

- Try the following checks before doing the System Diagnosis.
 1. Check Fuse 20 by visual inspection.
 2. Check that Compressor Clutch connector is firmly seated.
- Go to Heating and Air Conditioning (6410A-0) System Check for a guide to normal operation.
- Go to System Diagnosis for diagnostic tests.

SYSTEM DIAGNOSIS

- Do the tests listed for your symptom in the Symptom Table below.
- Tests follow the Symptom Table.

SYMPTOM TABLE

Compressor Clutch does not engage	A
Engine idle speed is not high enough when Compressor Clutch engages	D

A: A/C ISOLATION TEST (TABLE 1)

Measure: VOLTAGE At: EVAPORATOR TEMPERATURE REGULATOR (Disconnected) Conditions: <ul style="list-style-type: none"> • Ignition Switch: RUN (Engine need not be running) • A/C Selector Switch: ON (Depressed) 		
Measure Between	Correct Voltage	For Diagnosis
3 & Ground	Battery	See 1
<ul style="list-style-type: none"> • If voltage is correct, go to Table 2. 1. Go to Test E. 		

A: A/C ISOLATION TEST (TABLE 2)

Connect: FUSED JUMPER At: EVAPORATOR TEMPERATURE REGULATOR (Disconnected) Conditions: • Ignition Switch: RUN • A/C Selector Switch: ON (Depressed)		
Connect Across	Correct Result	For Diagnosis
2 & 3	Compressor Clutch Engages	See 1
• If result is correct go to Test C. 1. Go to Test B.		

B: PRESSURE SWITCH TEST

Measure: RESISTANCE At: EVAPORATOR TEMPERATURE REGULATOR CONNECTOR (Disconnected) Conditions: • Ignition Switch: OFF • Negative Battery Terminal: DISCONNECTED		
Measure Between	Correct Resistance	For Diagnosis
2 & Ground	Approximately 3 to 4 ohms	See 1
• If measurement is correct replace the Evaporator Temperature Regulator. 1. Check for an open Refrigerant Pressure Switch, A/C Temperature Switch, or associated wiring (see schematic). If Refrigerant Pressure Switch is open, check refrigerant pressure to be sure it is normal before replacing the switch. If the switches and related wiring are OK, replace the Compressor Clutch.		

C: EVAPORATOR TEMPERATURE REGULATOR VOLTAGE AND RESISTANCE TEST

Measure: RESISTANCE At: EVAPORATOR TEMPERATURE REGULATOR CONNECTOR (Disconnected) Conditions: • Ignition Switch: OFF • Negative Battery Terminal: DISCONNECTED		
Measure Between	Correct Resistance	For Diagnosis
1 & Ground	Approximately 3.5K to 4.5K ohms at 70°F (21°C)	See 1
4 & Ground	Less than 0.5 ohms	See 2
6 & Ground	Less than 0.5 ohms	See 2
5 & 2	Less than 0.5 ohms	See 3
• If all resistances are correct but Compressor Clutch does not operate normally, replace the Evaporator Temperature Regulator. 1. Check the BK/WT wire for an open or a short to ground (see schematic). Check the BR wire for an open (see schematic). If wires are good, replace the Evaporator Temperature Sensor. 2. Check the BR wire for an open (see schematic). 3. Check BK/RD for an open between terminal 5 and the Refrigerant Pressure Switch.		

6454-0 AUXILIARY FAN

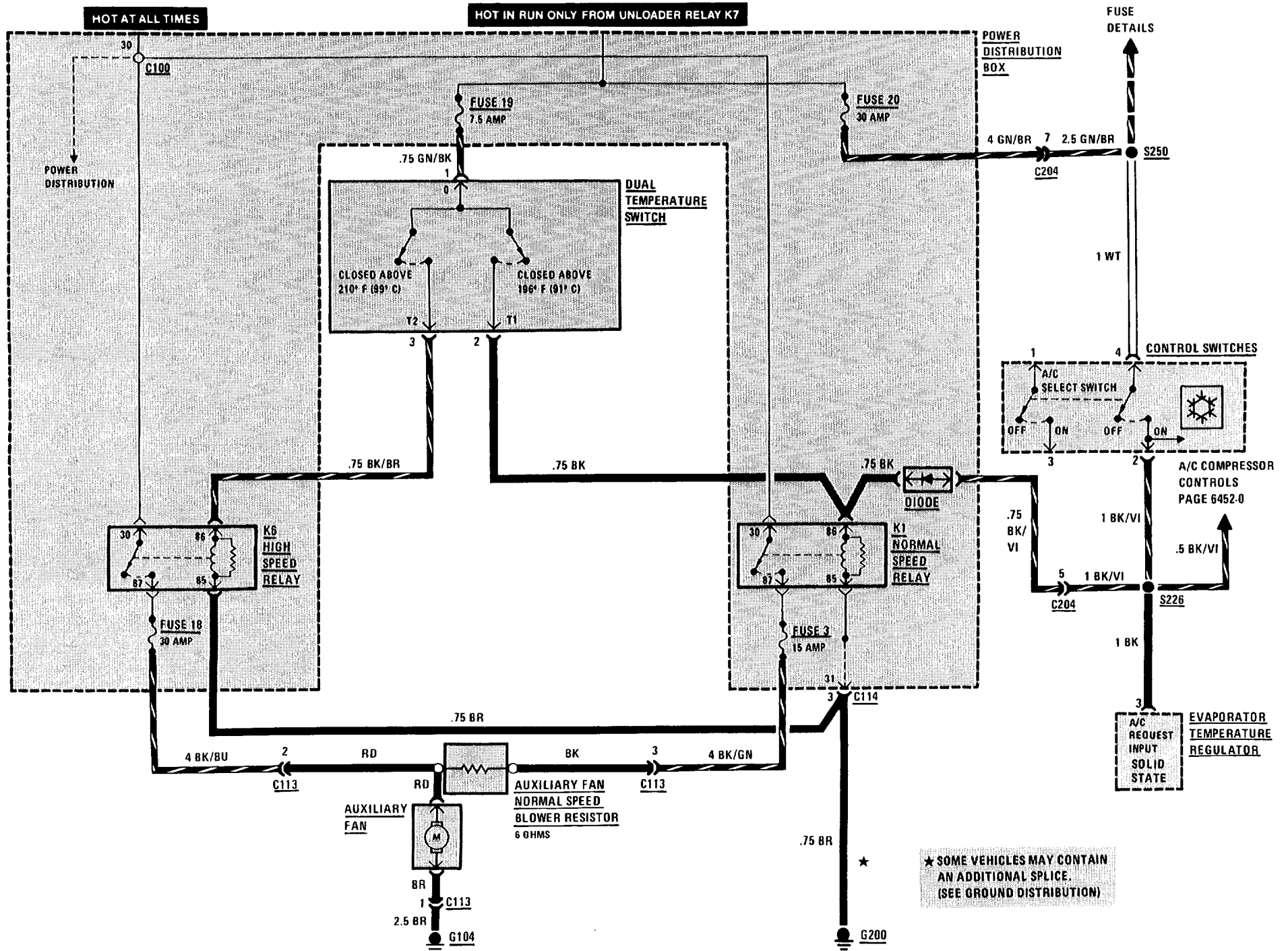

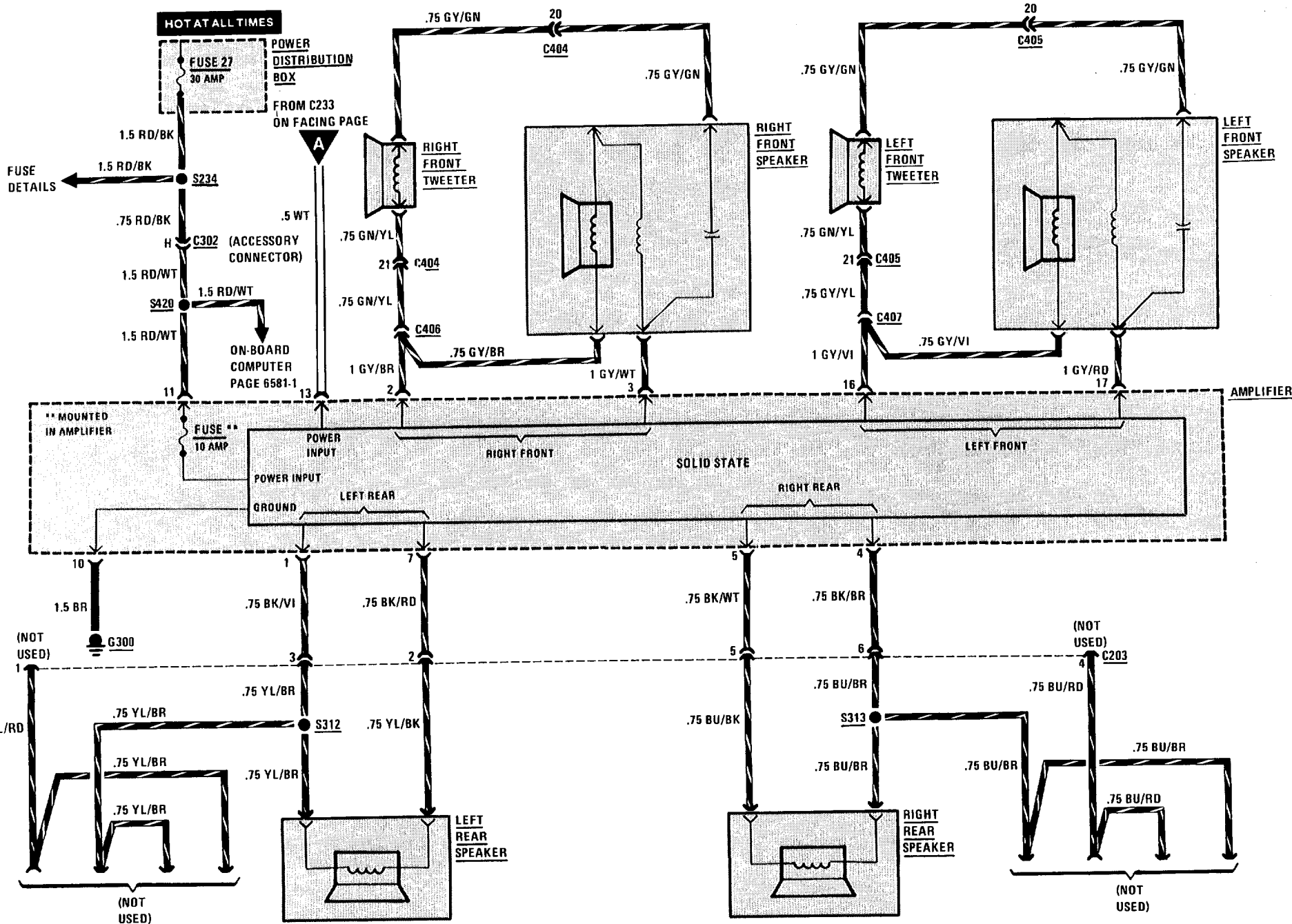

6500A-0 RADIO/ANTENNA

CIRCUIT OPERATION

With the Ignition Switch in ACCY, RUN or START, Fuse 12 provides voltage to turn on the three components in the system. When the Radio Switch is on, voltage is applied to the Radio and the Amplifier. This voltage is used to control the individual unit's main power supply.

Fuse 21 constantly supplies voltage to the Memory Power Input of the Radio. This allows the Radio to maintain the present settings while it is turned off.

The Amplifier receives constant power at terminal 11 from Fuse 27. When the Radio is on, voltage is applied to terminal 13 to enable the Amplifier.

The actual Radio signal originates at the Antenna. It is supplied to the Radio, processed, and output from the Left Channel and Right Channel Outputs. The signal is then input to the Left Front, Left Rear, Right Front and Right Rear Inputs to the Amplifier. After amplification, the signal is output to the corresponding speakers.

TROUBLESHOOTING HINTS

- Try the following checks before doing the System Check.
 1. Check power input to the Radio by observing if Instrument Cluster Indicators light.
 2. Check memory power to Radio by checking operation of the Glove Box Light.
 3. Check power input to the Amplifier.
 4. Check that the Antenna is properly connected.
 5. Before troubleshooting a suspect Speaker, check all connections to that Speaker.
 6. If display shows "CODE" and Radio will not operate, the individual Anti-Theft Code must be entered. Refer to "Anti-Theft" instruction booklet.
 7. Check Radio Fuse located on back of Radio.
 8. Check Amplifier Fuse located on back of Amplifier.
 9. For Radios without sound system. If a speaker is inoperative switch with a good speaker. If still inoperative, check related wiring. Remove Radio for service if wiring is OK.

SYSTEM CHECK

- Use the System Check Table as a guide to normal operation.
- Refer to System Diagnosis for a list of symptoms and diagnostic steps.

SYSTEM CHECK TABLE

ACTION	NORMAL RESULT
With Ignition Switch in RUN, turn Radio ON.	Digital display lights. Sound is emitted from all Speakers.
Operate Fader Control.	Sound volume varies from front to rear.

- Refer to System Diagnosis when a result is not normal.

SYSTEM DIAGNOSIS

- Do the tests listed for your symptom in the Symptom Table below.
- Tests follow the Symptom Table.

SYMPTOM TABLE

SYMPTOM	FOR DIAGNOSIS
Radio does not work (no display, no sound).	Do Test A
Digital display lights, but there is no sound.	Do Test B
LH Speakers or RH Speakers do not operate.	Do Test C

(Continued on next page)

(Continued from previous page)

An individual Speaker does not operate.	Do Test D
Excessive noise comes from all speakers.	Do Test E

A: RADIO POWER TEST

Measure: VOLTAGE At: RADIO CONNECTOR C216 (Disconnected) or CONNECTOR C215 (Disconnected) Condition: • Ignition Switch: RUN		
Measure Between	Correct Voltage	For Diagnosis
C216/2 & Ground	Battery	See 1
C216/2 & C216/1	Battery	See 2
C215/2 & Ground	Battery	See 3
• If all voltages are correct, check wire from connector C215 to Radio for an open. If wire is OK, remove Radio for service. 1. Check power input wire for an open 2. Check ground wire for an open to ground. Make sure ground G200 is clean and tight. 3. Check memory power supply wire for an open.		

B: AMPLIFIER POWER TEST

Measure: VOLTAGE At: AMPLIFIER CONNECTOR (Disconnected) Conditions: • Ignition Switch: RUN • Radio: ON		
Measure Between	Correct Voltage	For Diagnosis
11 & Ground	Battery	See 1
11 & 18	Battery	See 2
13 & Ground	Battery	See 3
11 & 10	Battery	See 4
• If all voltages are correct, go to Test C. 1. Check power supply wire for an open. 2. Check Amplifier ground to Amplifier for an open to ground. Make sure ground G200 is clean and tight. 3. Check Amplifier "Radio On" wire for an open. 4. Check wire from terminal 10 for an open to ground. Make sure ground G106 is clean and tight.		

C: FADER SIGNAL TEST (WITH SOUND SYSTEM)

Measure: VOLTAGE At: AMPLIFIER CONNECTOR (Disconnected) Conditions: • Ignition Switch: RUN • Radio: ON		
Measure Between	Correct Voltage	For Diagnosis
14 & Ground	Approximately 6 Volts	See 1
15 & Ground	Approximately 6 Volts	See 1
19 & Ground	Approximately 6 Volts	See 1
20 & Ground	Approximately 6 Volts	See 1
• If all voltages are correct but sound was not present, remove Amplifier for service. 1. Check between Radio and Amplifier for an open in the wiring. If wire is OK, remove Radio for service.		

6500A-2 RADIO/ANTENNA

D: SUSPECT SPEAKER TEST

Connect: OHMMETER At: SUSPECT SPEAKER (Disconnected) Condition: <ul style="list-style-type: none"> • Ohmmeter set on Rx 1 scale or Diode Check Scale 		
Action	Correct Result	For Diagnosis
Connect Ohmmeter across Speaker Terminals	Speaker "pops"	See 1
<ul style="list-style-type: none"> • If the result is correct, check wires to the Amplifier or Radio for opens or shorts. If wires are OK, check the related wire between Radio and Amplifier. If OK, remove Radio for service. <ol style="list-style-type: none"> 1. Replace the suspect Speaker. 		

E: NOISE DIAGNOSIS

With Radio on and noise present, unplug the Antenna at the back of the Radio.

- If noise is no longer present, it was being picked up by the Antenna. Perform Antenna Noise Test.
- If noise persists, it is coming in the Radio wiring. Refer to the following Noise Symptom Table.

ANTENNA NOISE TEST

Measure: RESISTANCE At: ANTENNA		
Measure Between	Correct Resistance	For Diagnosis
Antenna Plug Base & Ground	Less than 3 Ohms	See 1
Antenna Plug Tip & Antenna Plug Base	Greater than 1 Megaohm (open circuit)	See 2
<ul style="list-style-type: none"> • If both resistances are correct, check the hood ground strap. If OK, substitute different Antenna at Radio. If good, replace Antenna. If noise is still present, refer to Noise Symptom Table. <ol style="list-style-type: none"> 1. Check ground contact at Antenna base. If necessary, install a braided ground strap from the Antenna Base to Chassis ground. Check for an open in the Antenna Cable. 2. Check for a short to ground at the Antenna or Antenna cable. 		

NOISE SYMPTOM TABLE

SYMPTOM	POSSIBLE CAUSE	REPAIR ACTION
Harsh popping or crackling noise present when ignition on-changes with engine rpm.	Ignition Noise	<ul style="list-style-type: none"> • Check for proper distributor cap shielding. • Check shielding ground strap. If not present, install. • Check for defective spark plug or spark plug wire. • Reroute spark plug wires laying against anything that could be transmitting noise to the Radio (wiring or sensor leads traveling into the passenger compartment). • Check engine/firewall ground strap and engine hood/body ground strap. • Check if engine hood is closing properly. • Connect dedicated ground strap to Radio. • Replace distributor cap and rotor.
High whine or howling that changes with engine rpm.	Alternator noise	<ul style="list-style-type: none"> • Connect dedicated ground strap to Radio. • Run a direct wire from Battery to Alternator.
AM only is weak and noisy.	AM alignment	<ul style="list-style-type: none"> • Remove Radio for service.
FM only is weak and noisy.	FM alignment	<ul style="list-style-type: none"> • Remove Radio for service.

6571-0 CRUISE CONTROL

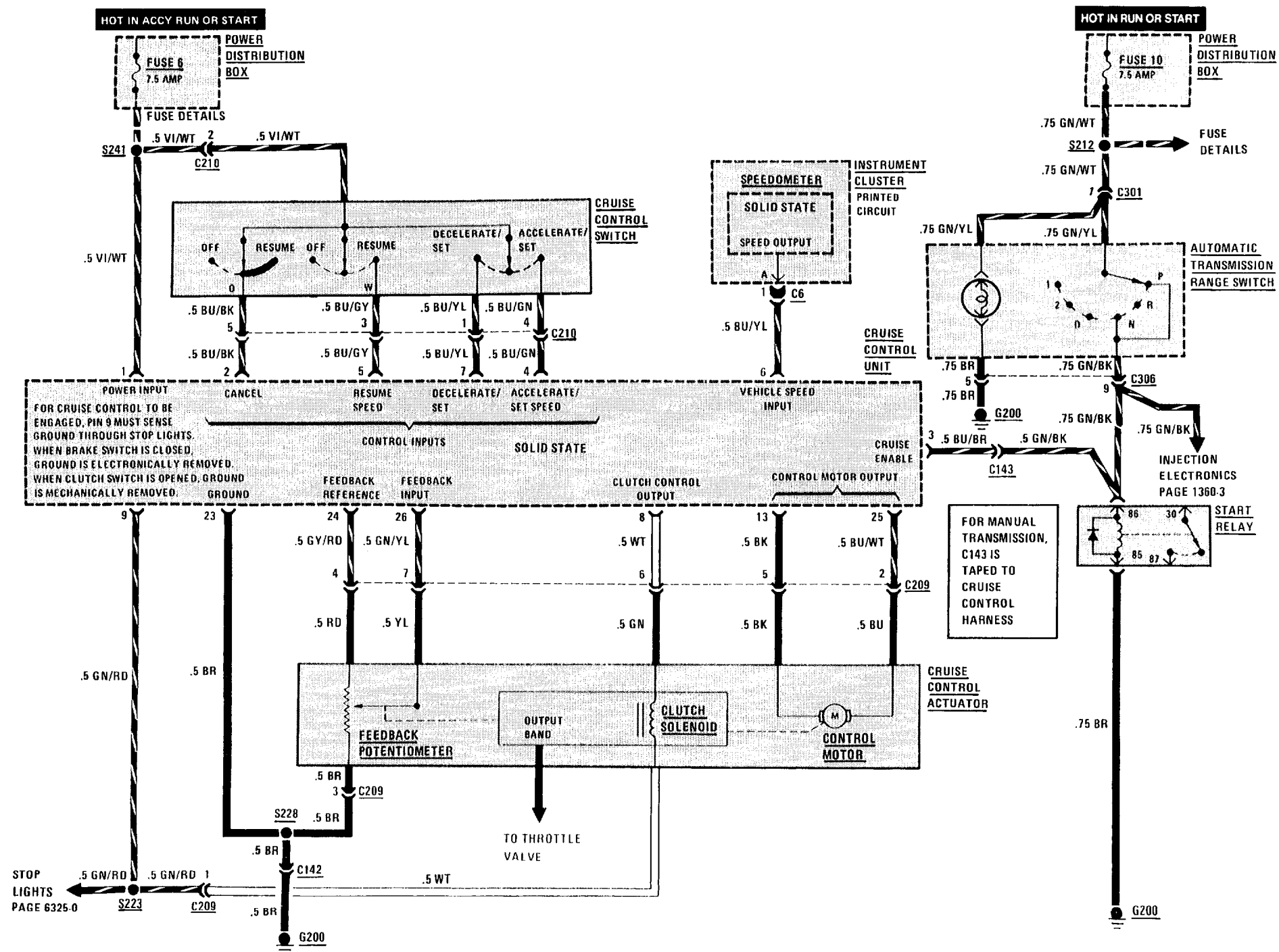

6581-0 ON-BOARD COMPUTER

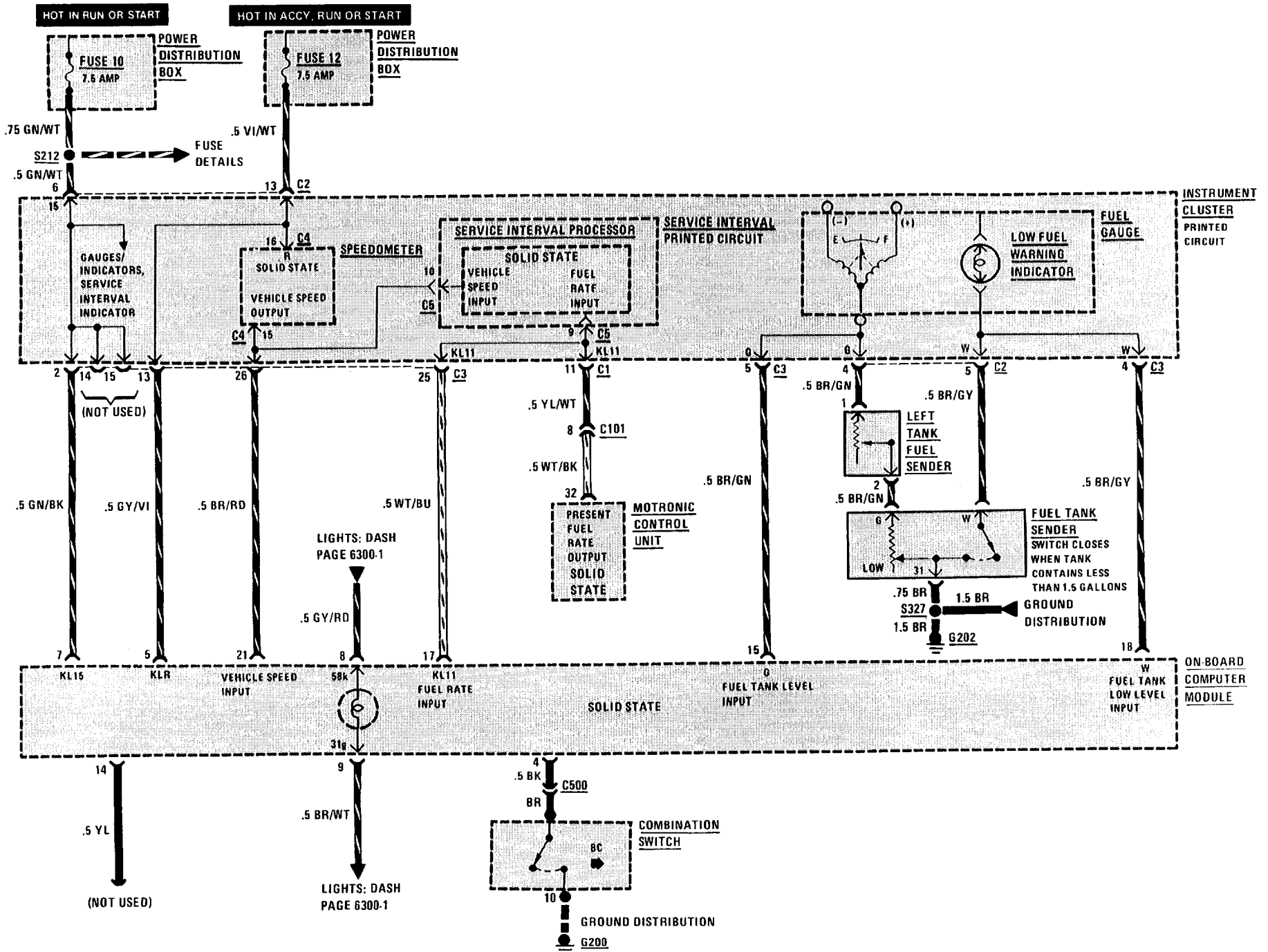

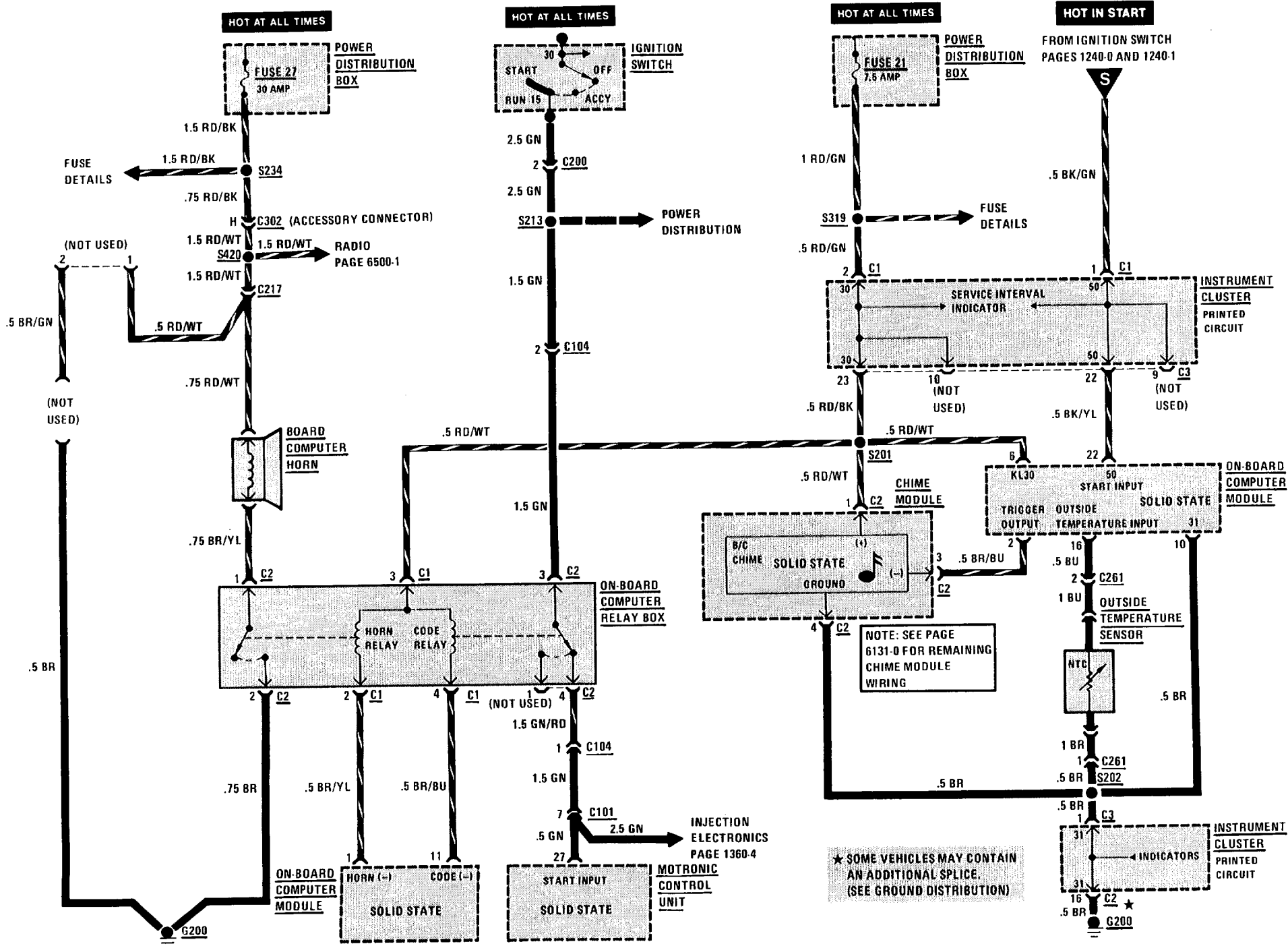

7000-0 COMPONENT LOCATION VIEWS

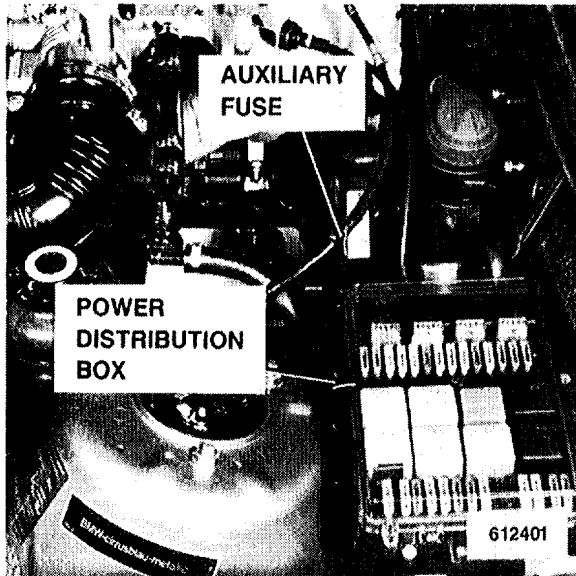

Figure 1 - LH Rear of Engine Compartment



Figure 3 - LH Rear of Engine Compartment

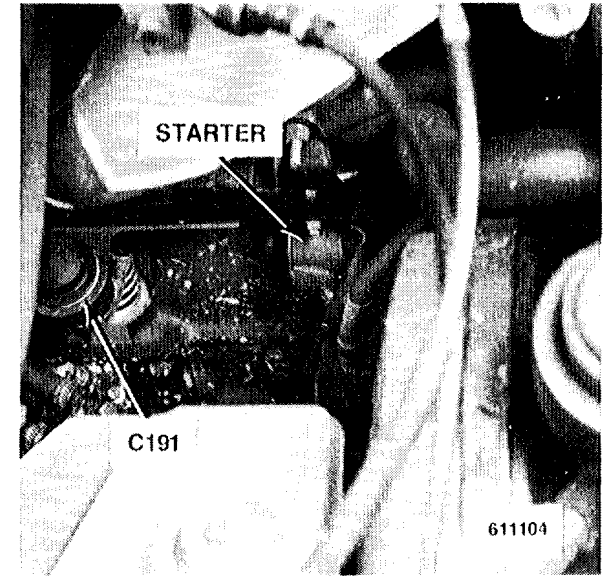

Figure 5 - Lower LH Rear of Engine

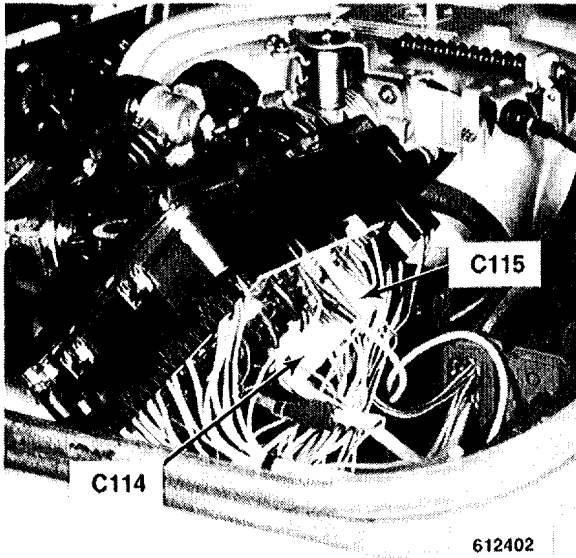

Figure 2 - LH Rear of Engine Compartment
(Inside Power Distribution Box)

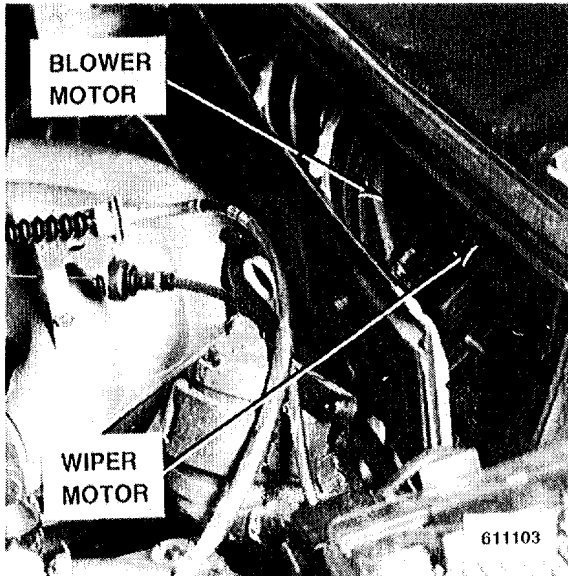

Figure 4 - Behind Fresh Air Intake Cowl

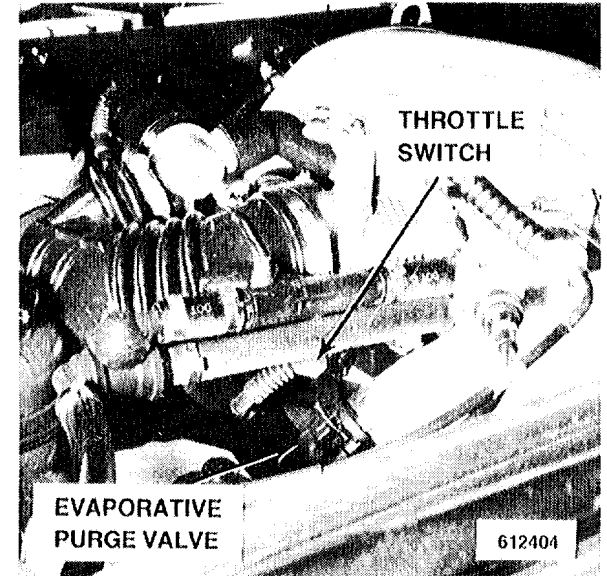

Figure 6 - LH Side of Engine

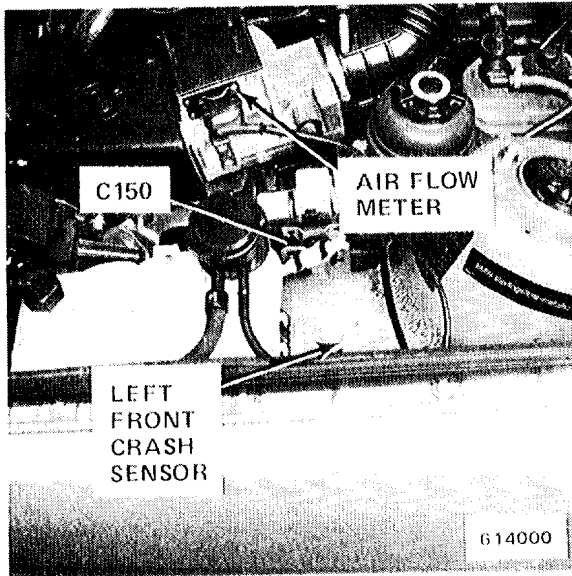

Figure 1 - Forward of LH Shock Tower
(Relay Cover Removed)

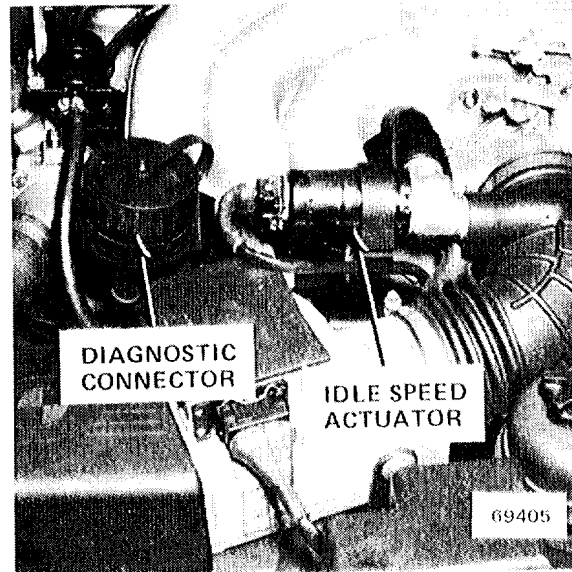

Figure 3 - LH Front of Engine

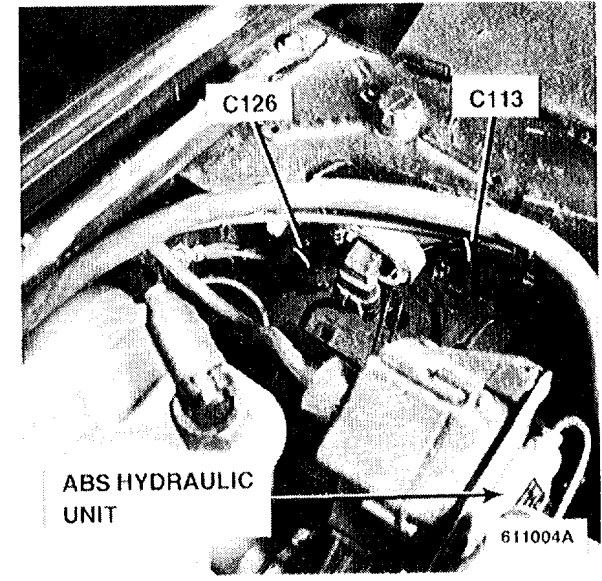

Figure 5 - LH Front Corner of Engine
Compartment

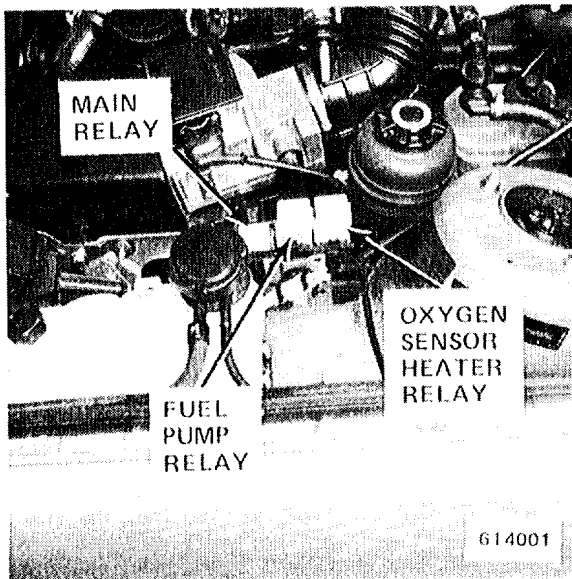

Figure 2 - Forward of LH Shock Tower
(Relay Cover Removed)

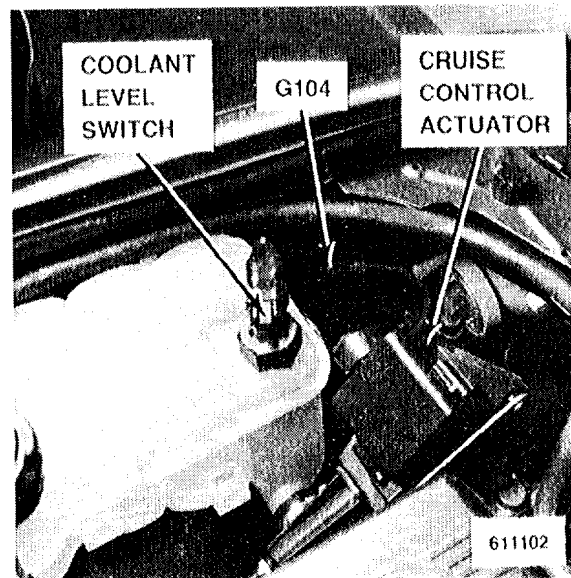

Figure 4 - LH Front Corner of Engine
Compartment



Figure 6 - Lower LH Side of Engine

7000-2 COMPONENT LOCATION VIEWS

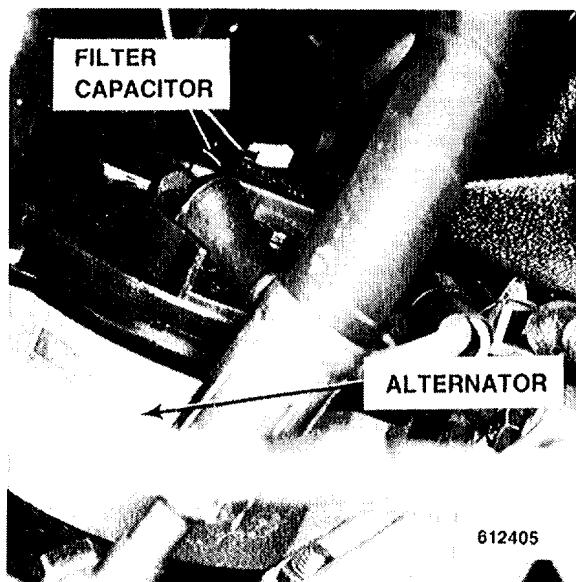

Figure 1 - Lower LH Front of Engine
(From Below Car)

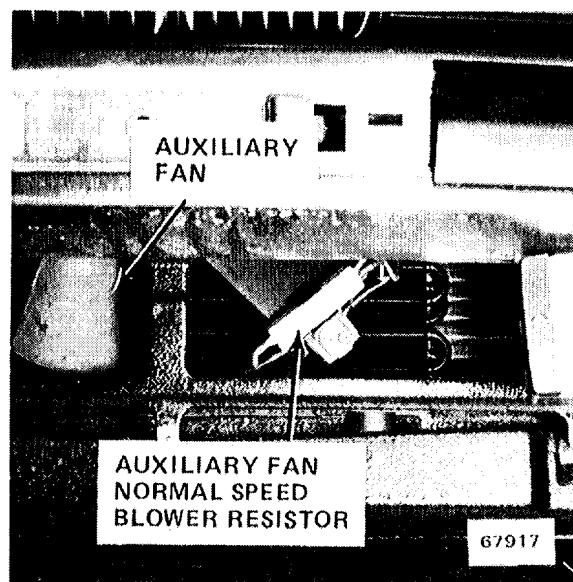

Figure 3 - Behind Center of Front Bumper

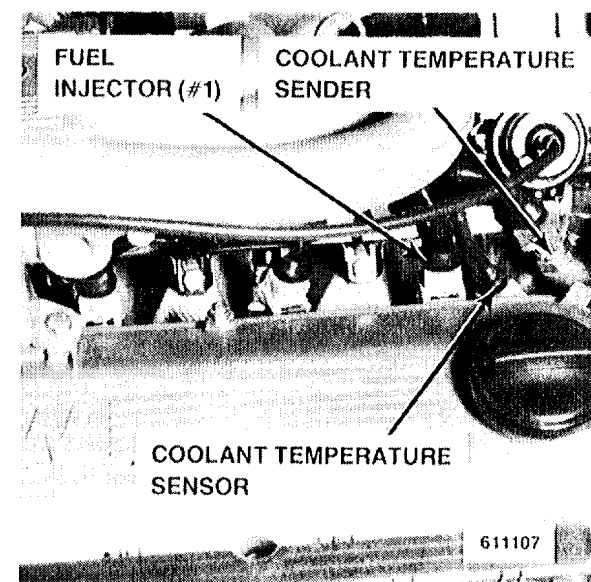

Figure 5 - Top Front of Engine

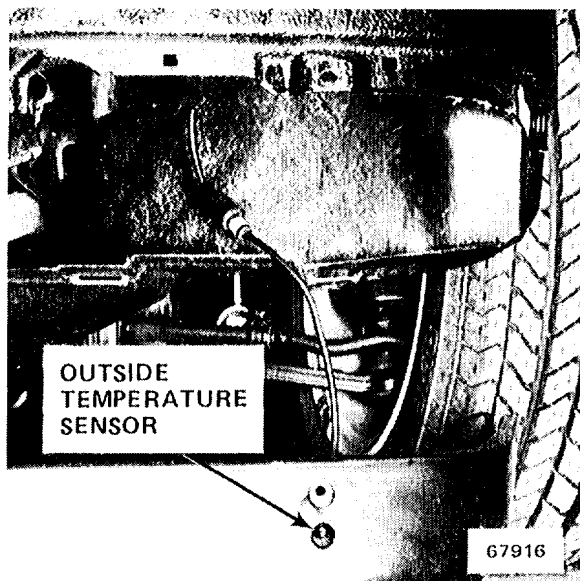

Figure 2 - Behind LH Side of Front Bumper

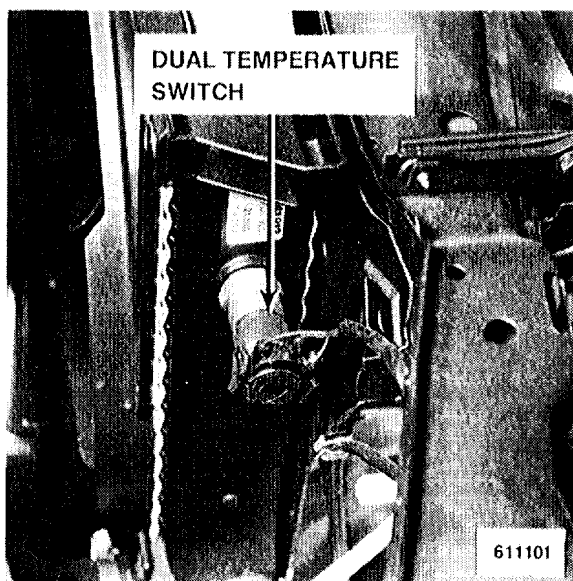

Figure 4 - Top RH Side of Radiator

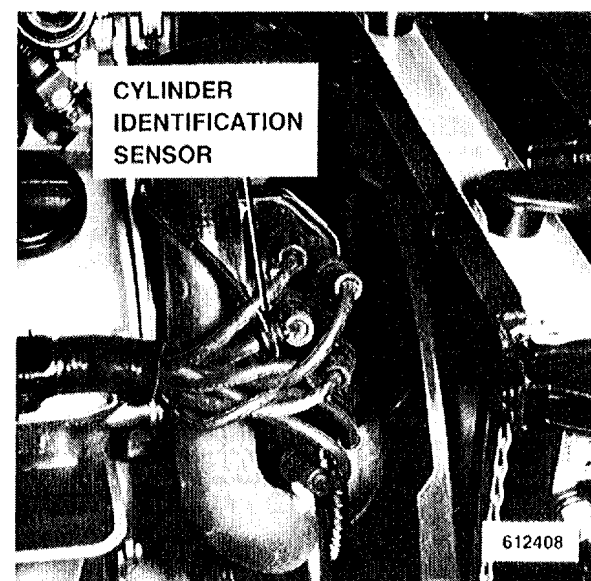

Figure 6 - RH Front of Engine

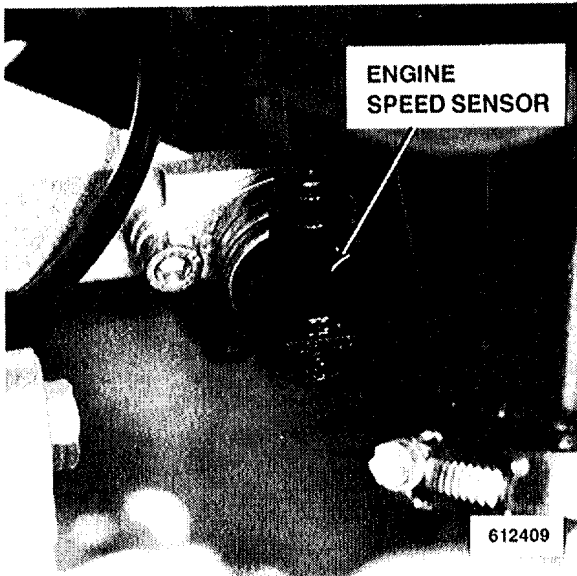

Figure 1 - Lower RH Front of Engine



Figure 3 - Lower RH Front of Engine

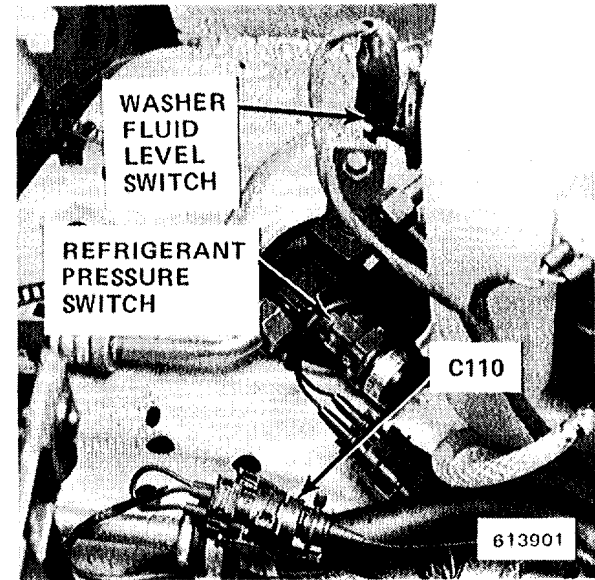

Figure 5 - RH Front of Engine Compartment

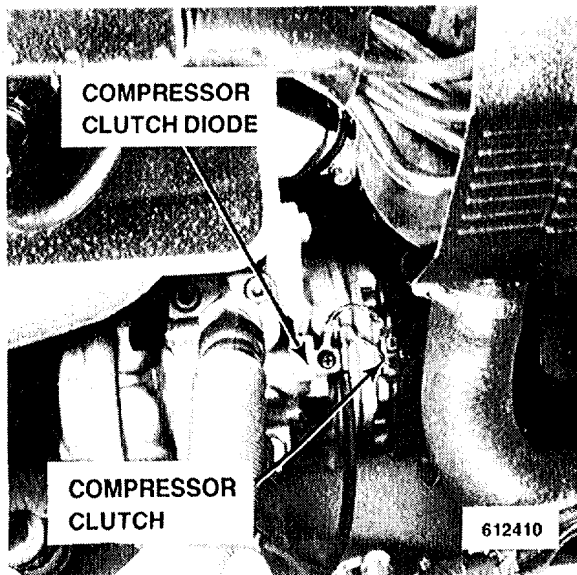

Figure 2 - Lower RH Front of Engine

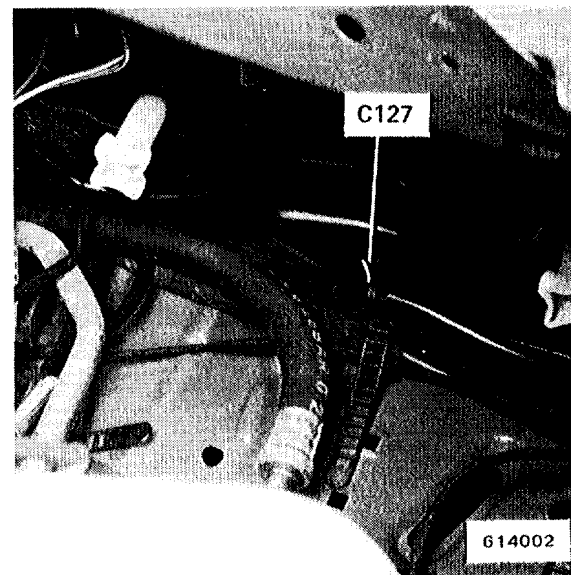

Figure 4 - RH Front Corner of Engine Compartment

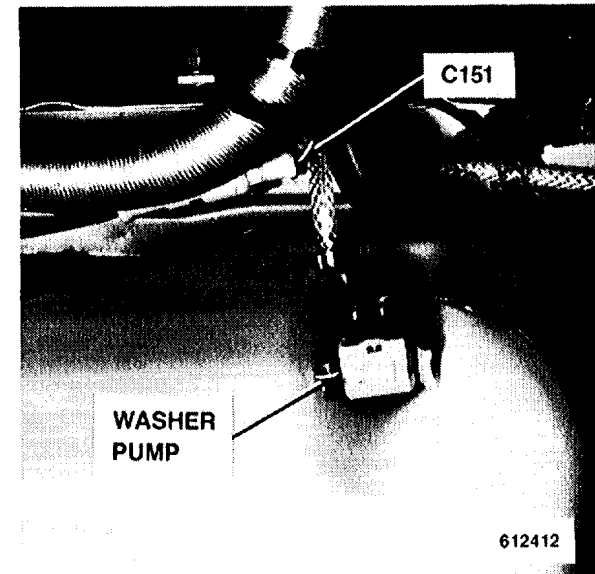

Figure 6 - RH Side of Engine Compartment

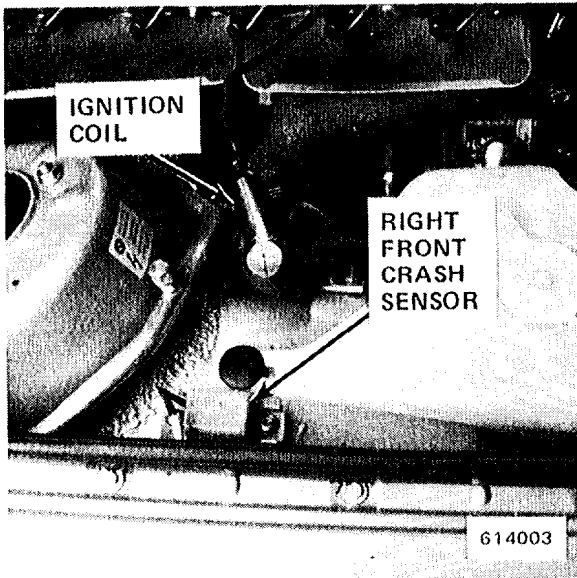

Figure 1 - RH Side of Engine Compartment

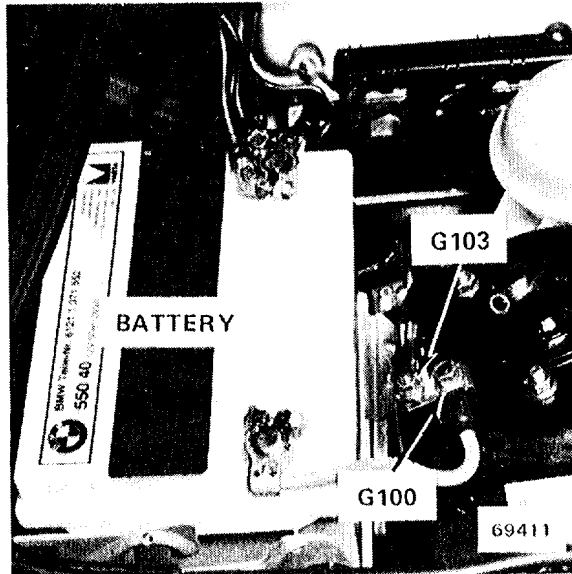

Figure 3 - RH Rear of Engine Compartment

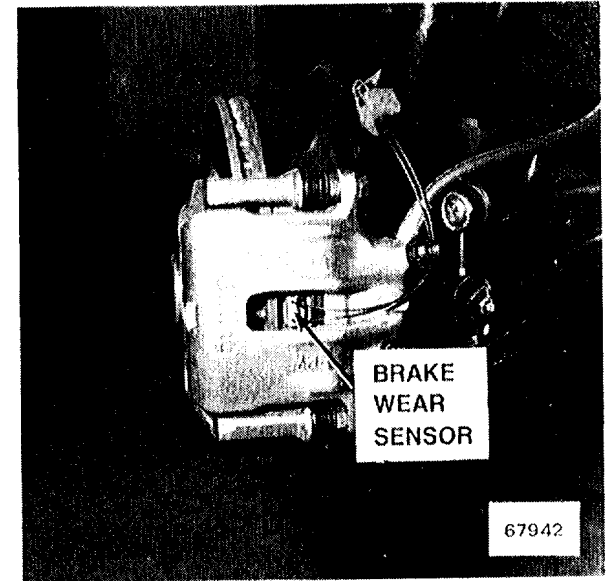

Figure 5 - LH Front Brake Assembly
(Wheel Removed)
(RH Rear Similar)

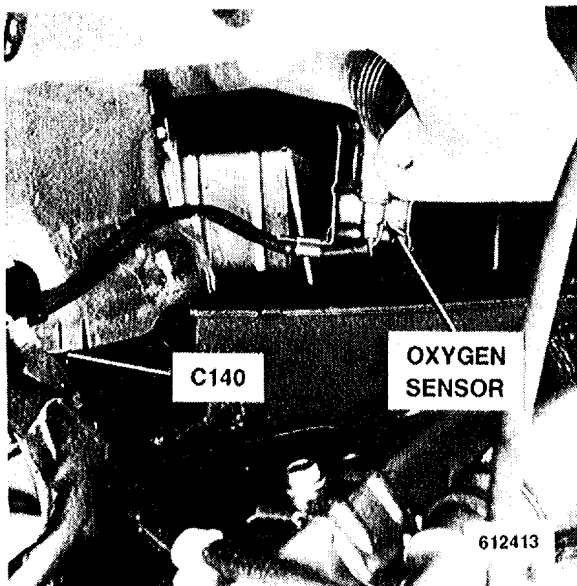

Figure 2 - Lower RH Rear of Engine

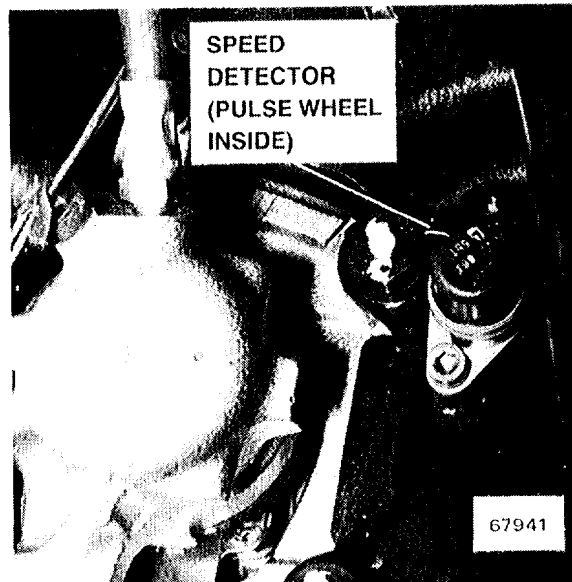

Figure 4 - LH Front Spindle Assembly
(All Others Similar)

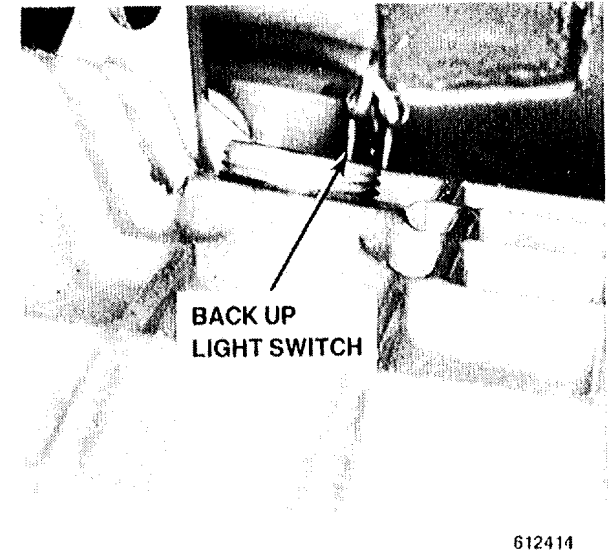

Figure 6 - RH Side of Transmission

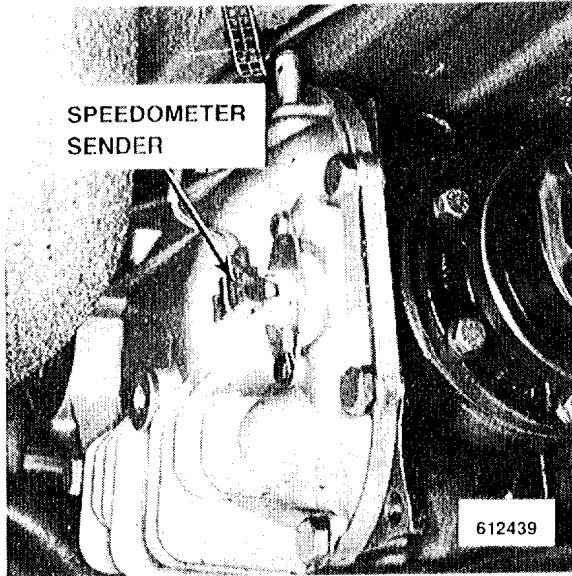

Figure 1 - Rear of Rear Differential

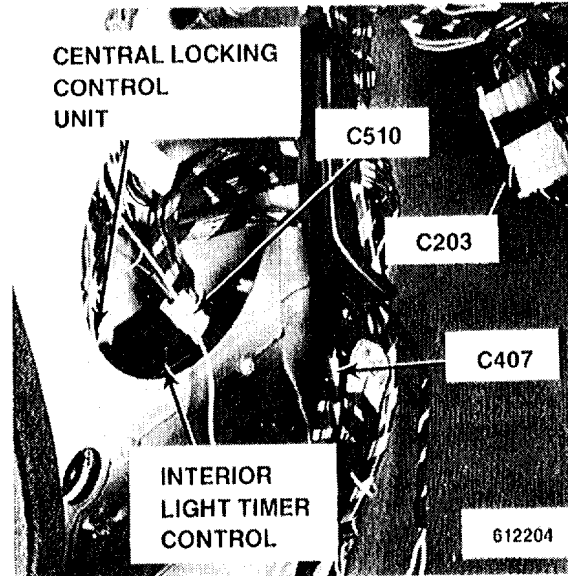

Figure 3 - LH Kick Panel
(Speaker Removed)

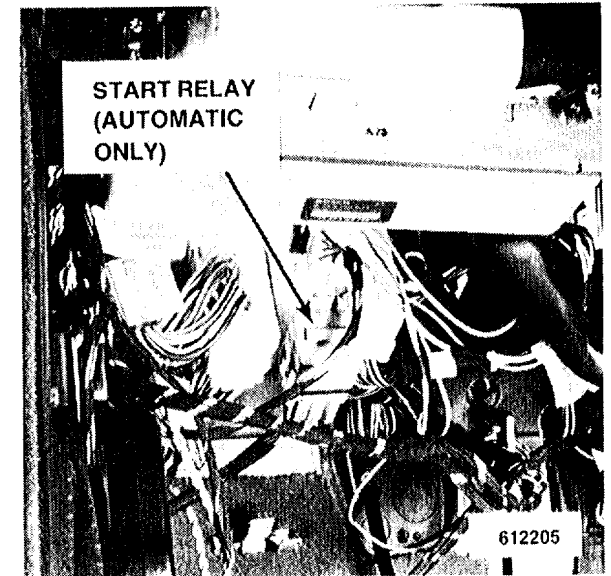

Figure 5 - Below LH Side of Dash,
Left of Steering Column

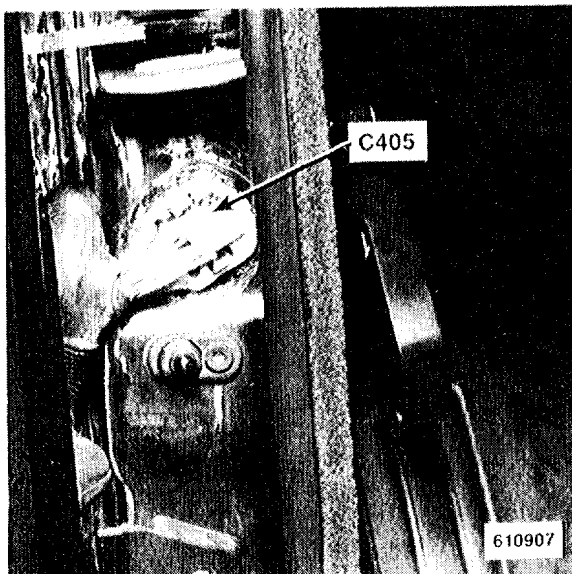

Figure 2 - Above LH Front Door Jamb Switch

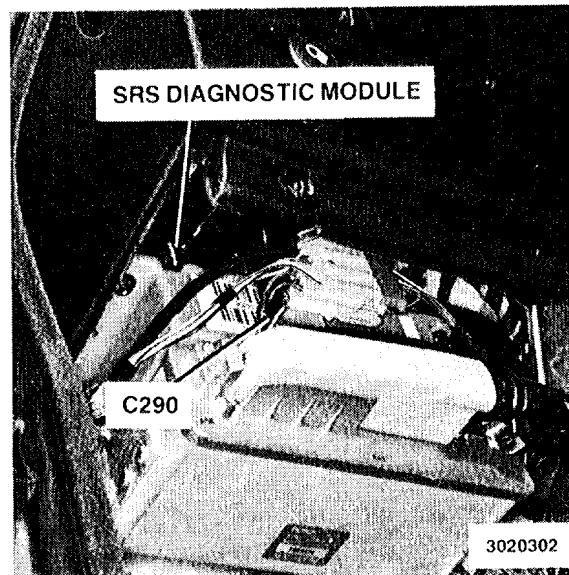

Figure 4 - Below LH Side of Dash,
Left of Steering Column

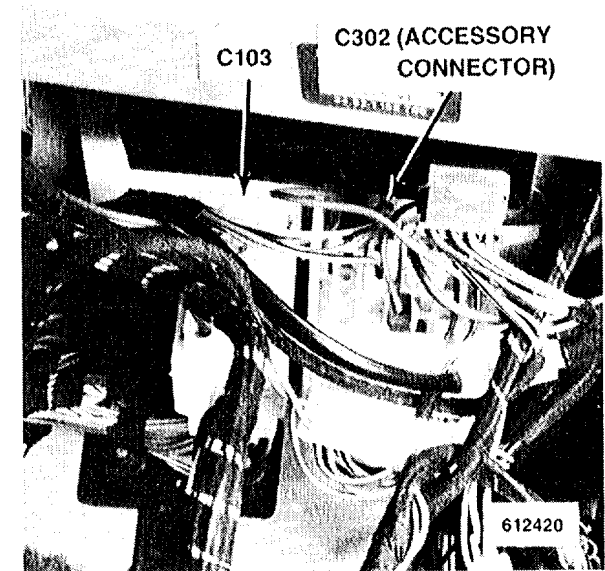

Figure 6 - Below LH Side of Dash,
Left of Steering Column

7000-6 COMPONENT LOCATION VIEWS

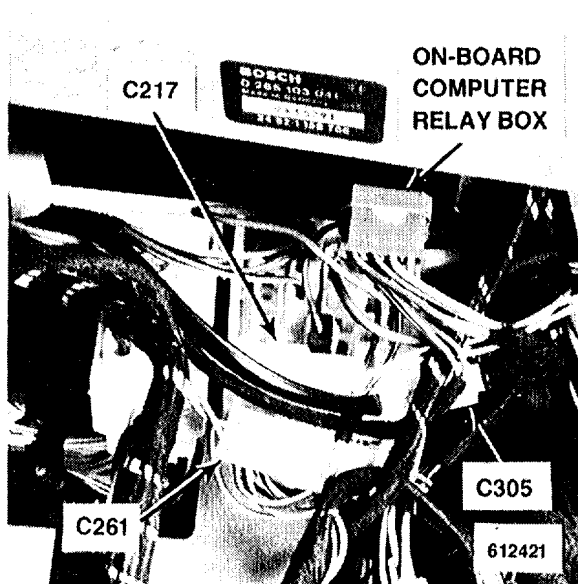

Figure 1 - Below LH Side of Dash, Left of Steering Column

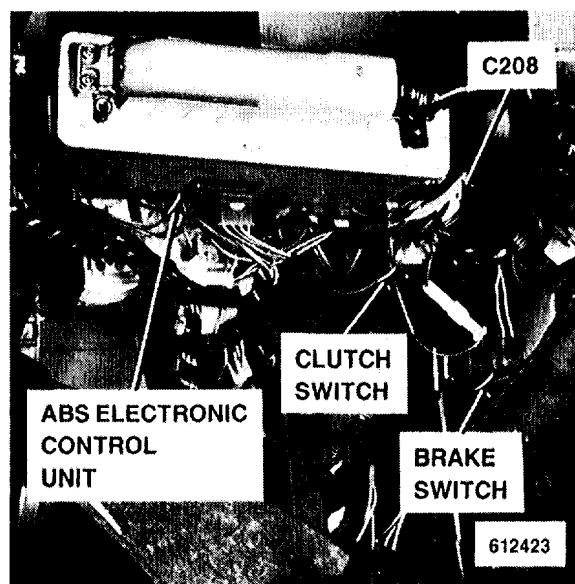

Figure 3 - Below LH Side of Dash, Left of Steering Column

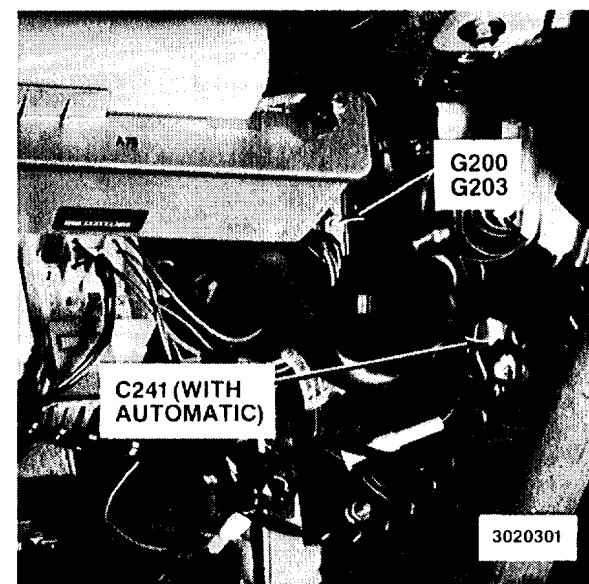

Figure 5 - Below LH Side of Dash, Left of Steering Column

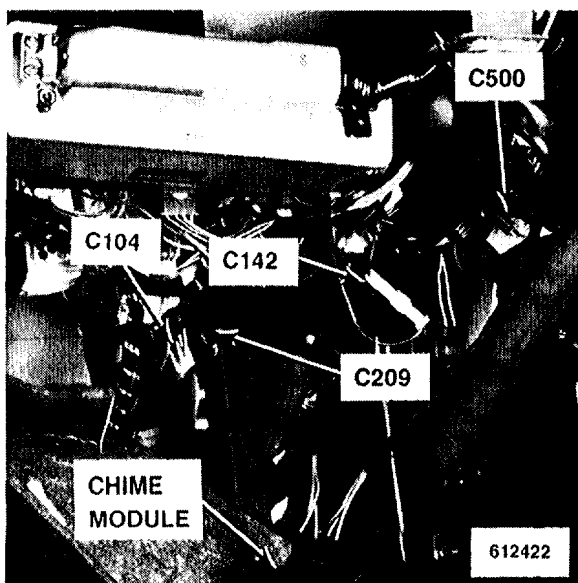

Figure 2 - Below LH Side of Dash, Left of Steering Column

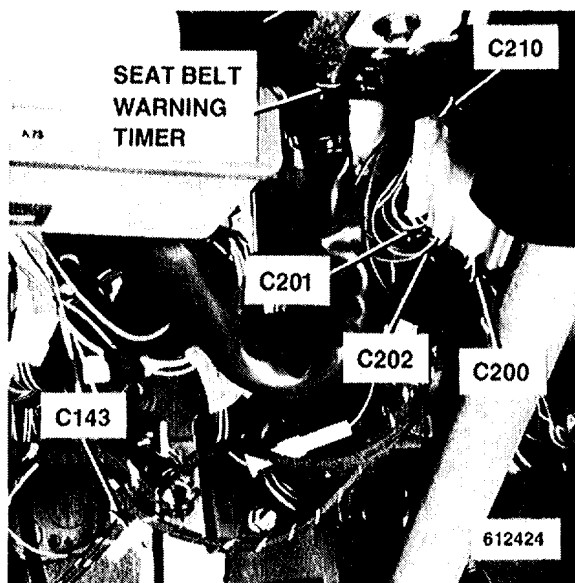

Figure 4 - Below LH Side of Dash, Left of Steering Column

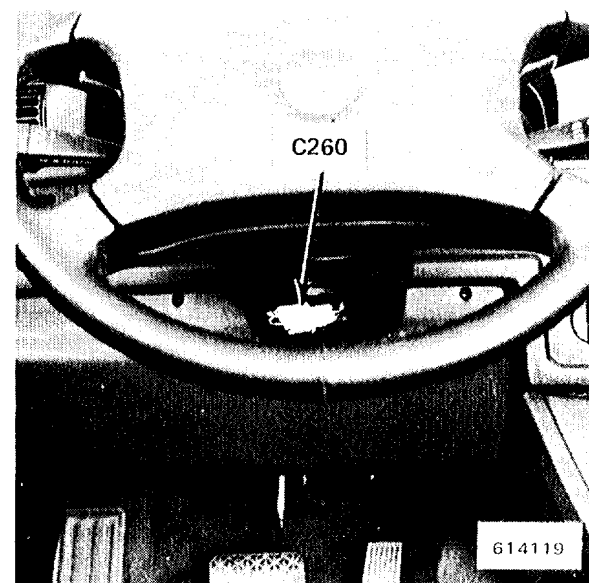

Figure 6 - Underside of Steering Column

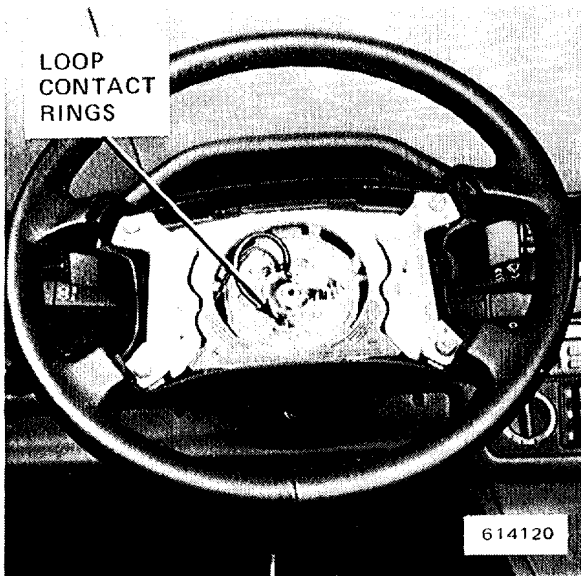

Figure 1 - Top of Steering Column
(Air Bag Gas Generator Removed)

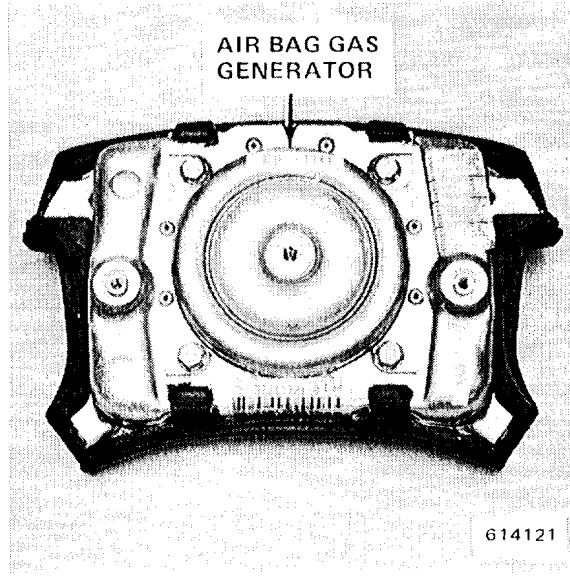

Figure 3 - Inside Steering Wheel
(Removed From Car)

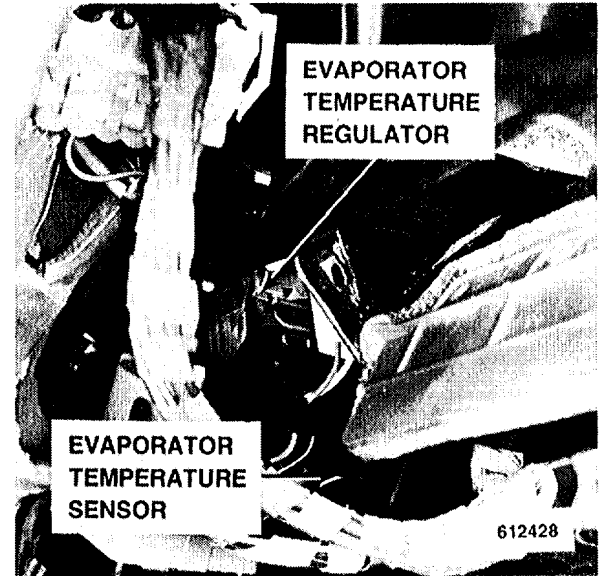

Figure 5 - LH Side of Evaporator Housing

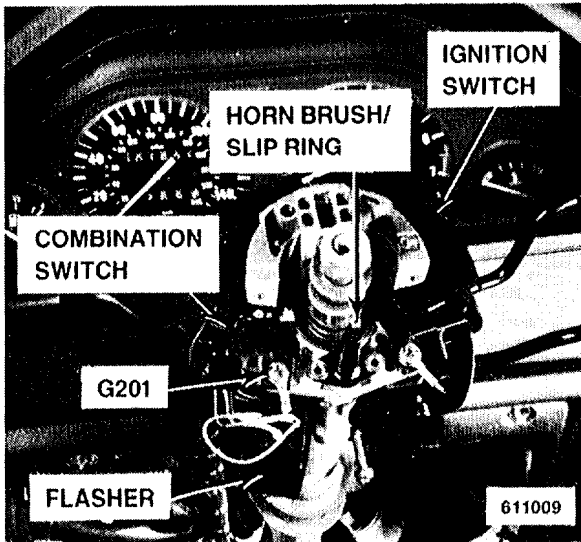

Figure 2 - Top of Steering Column
(Steering Wheel Removed)

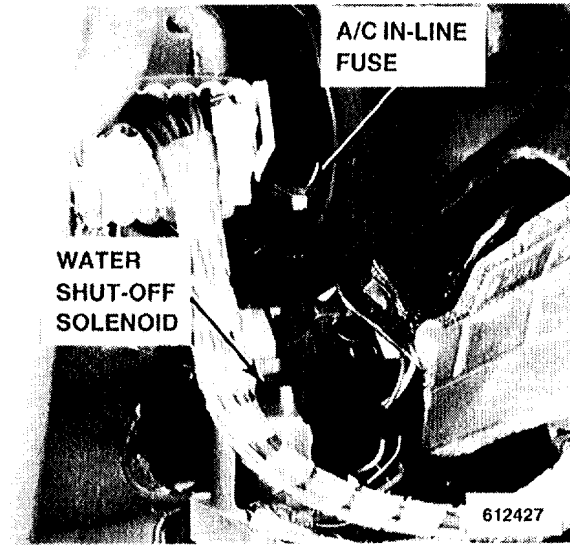

Figure 4 - LH Side of Evaporator Housing

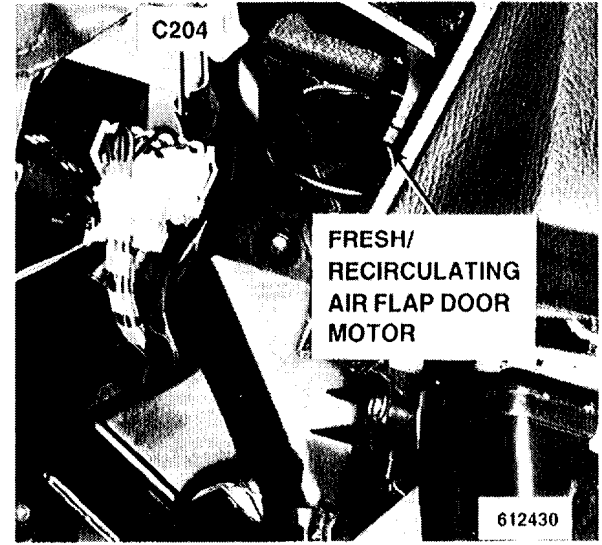

Figure 6 - LH Side of Evaporator Housing

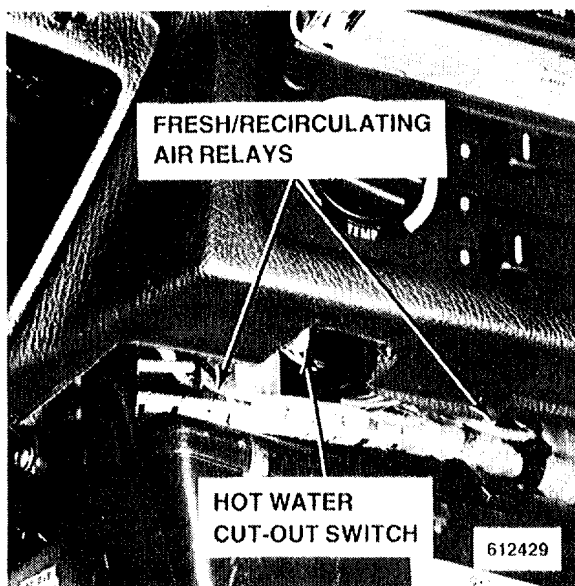

Figure 1 - Behind Center of Dash

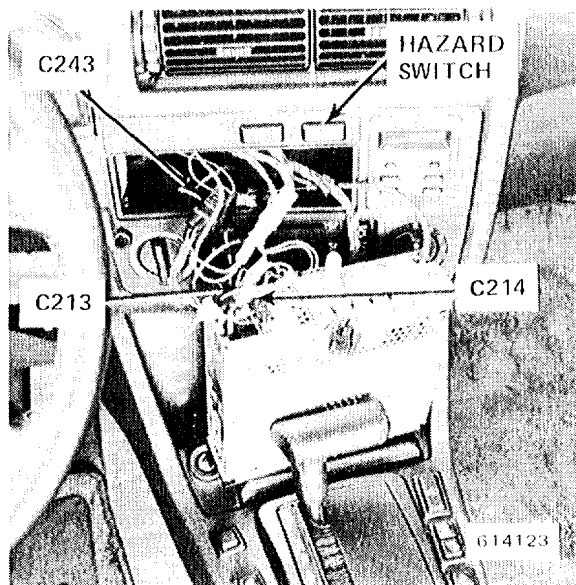

Figure 3 - Behind Center of Dash
(325i Shown; 325iC Similar)

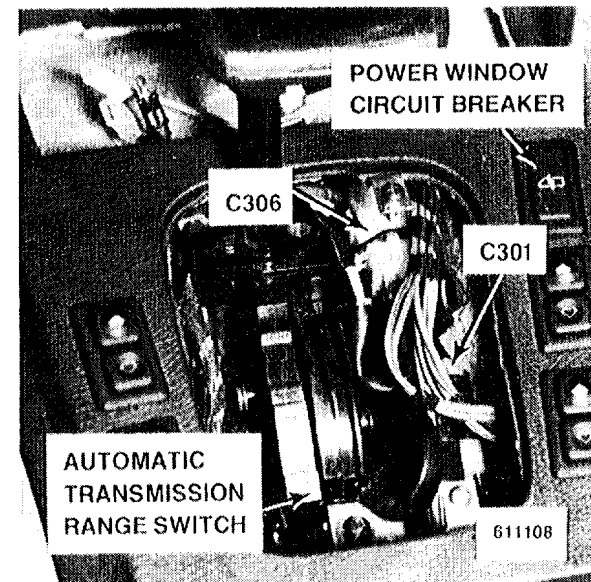

Figure 5 - Below Center Console

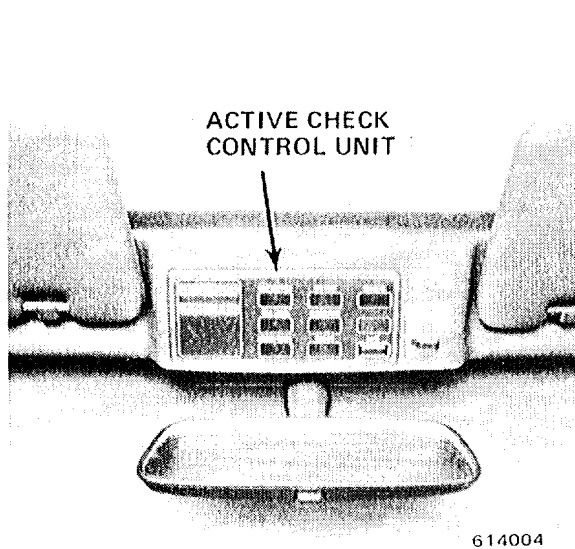

Figure 2 - Center of Windshield Header

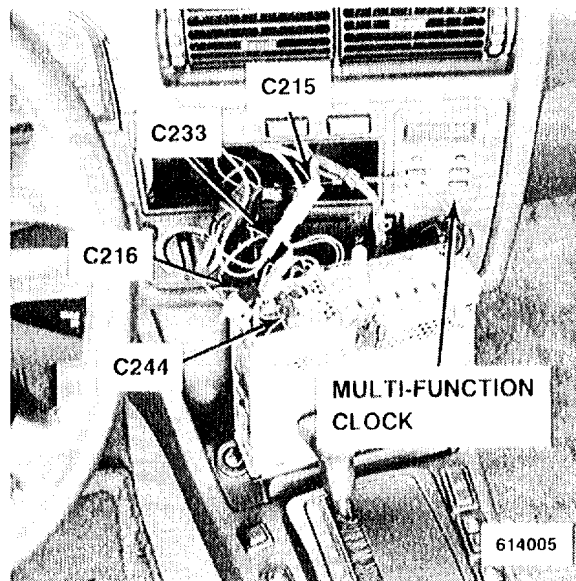

Figure 4 - Behind Center of Dash
(325i Shown; 325iC Similar)

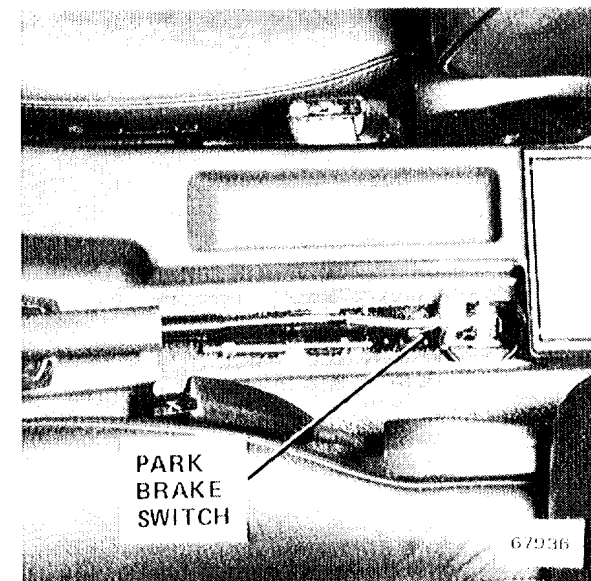

Figure 6 - Below Rear of Center Console

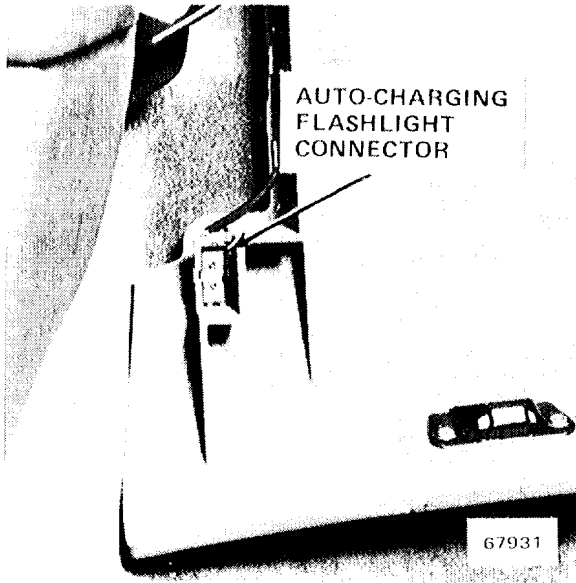

Figure 1 - LH Side of Glove Box

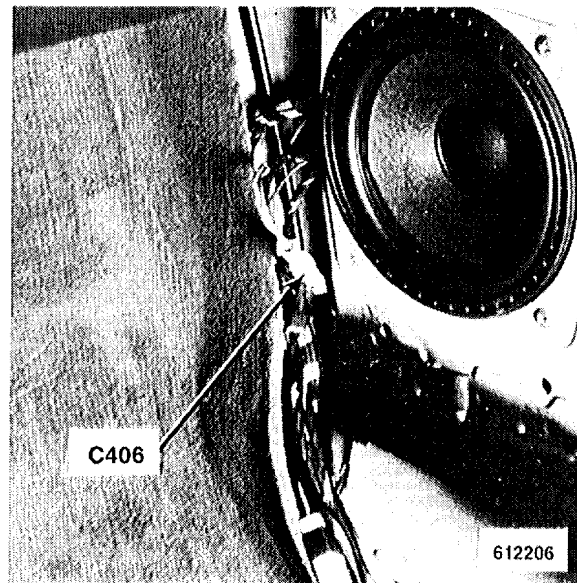

Figure 3 - RH Kick Panel

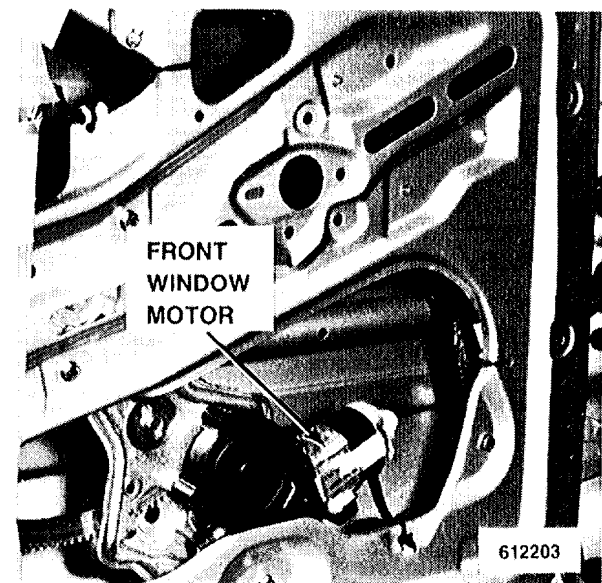

Figure 5 - Inside Front of LH Front Door (RH Similar)

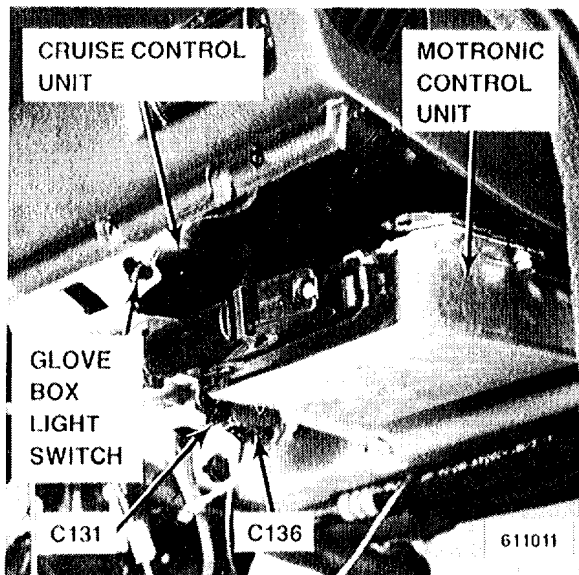

Figure 2 - Below RH Side of Dash, Above Glove Box

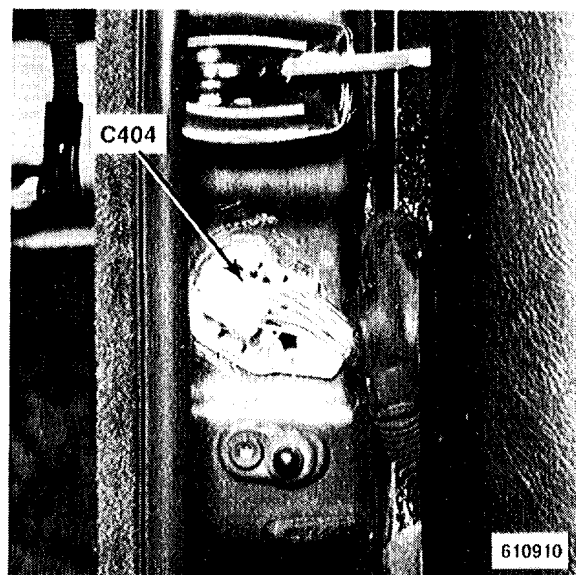

Figure 4 - Above RH Front Door Jamb Switch

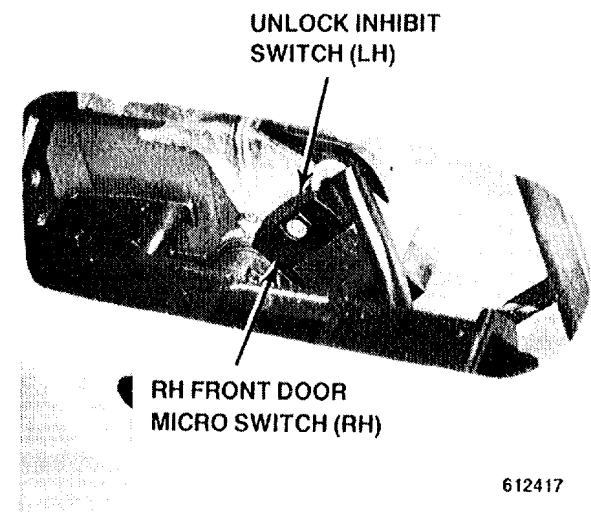

Figure 6 - Inside Rear of LH Front Door (RH Similar)



Figure 1 - Inside Rear of LH Front Door

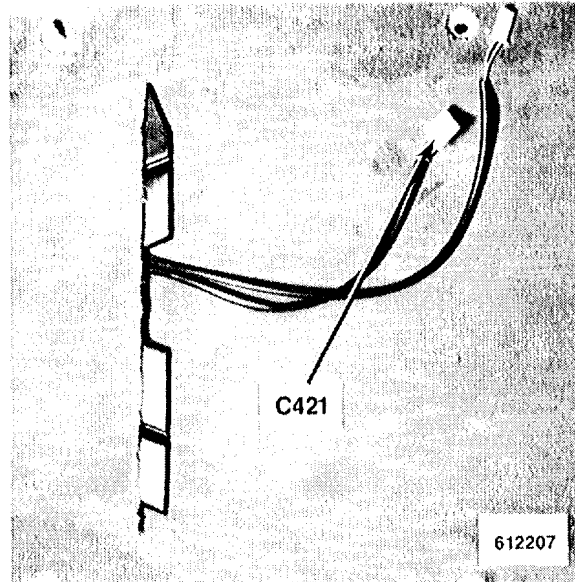

Figure 3 - Below LH Front Seat

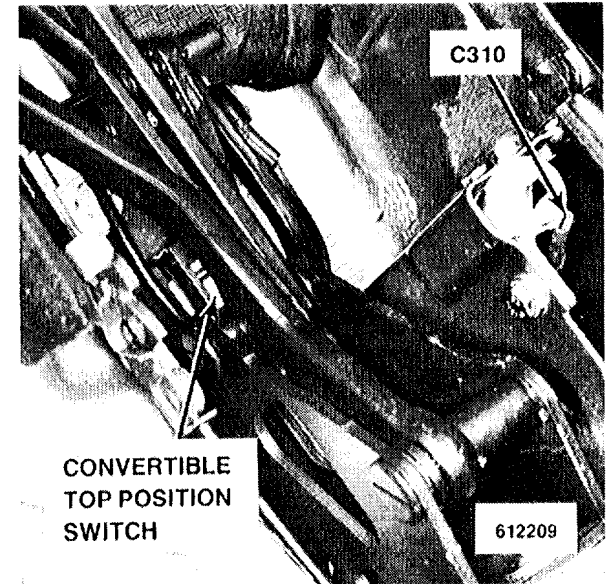

Figure 5 - LH Side of Soft Top Stowage Compartment

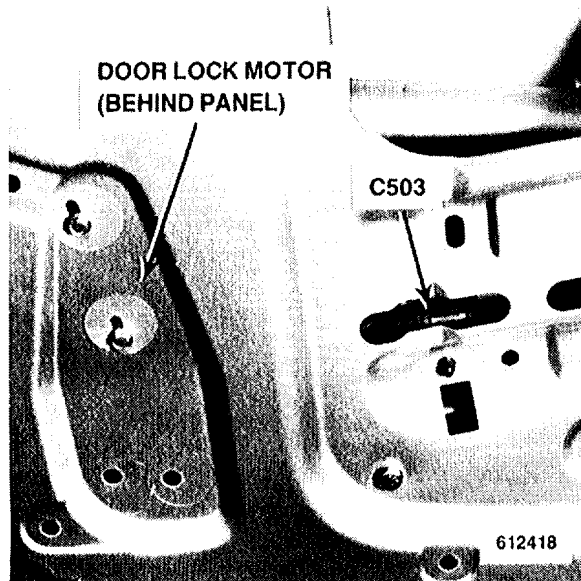

Figure 2 - Inside Rear of LH Front Door (RH Similar)

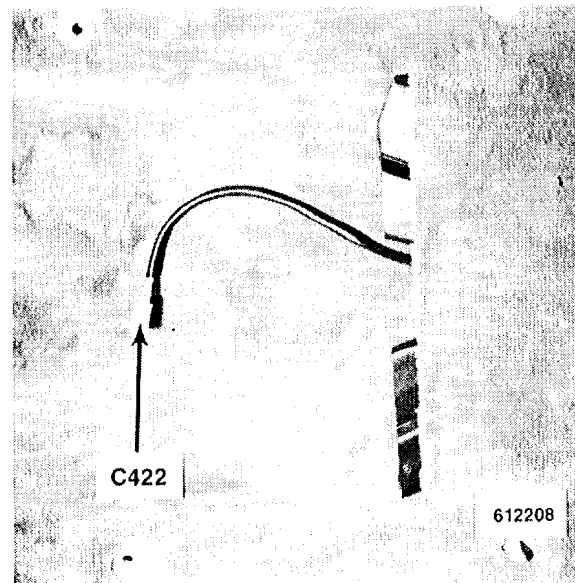

Figure 4 - Below RH Front Seat

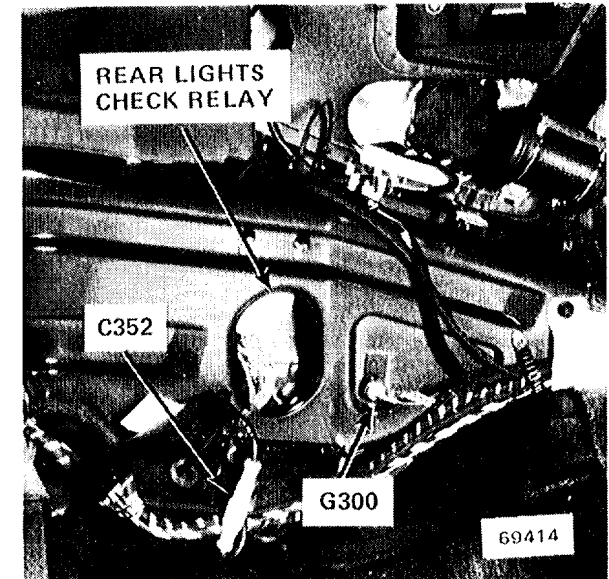

Figure 6 - Below LH Side of Rear Seat

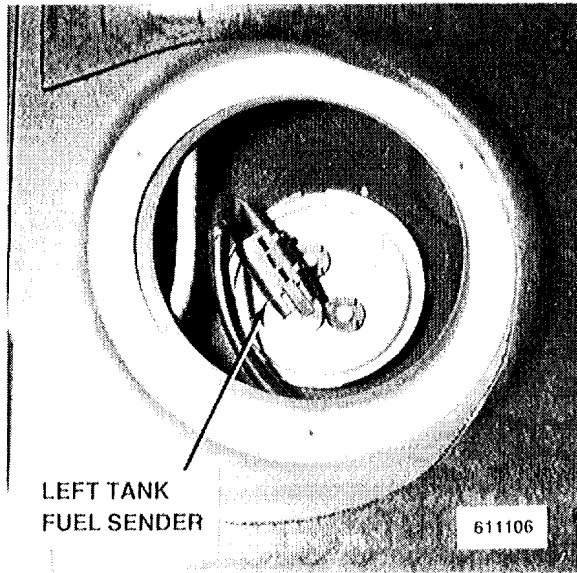

Figure 1 - Below LH Side of Rear Seat

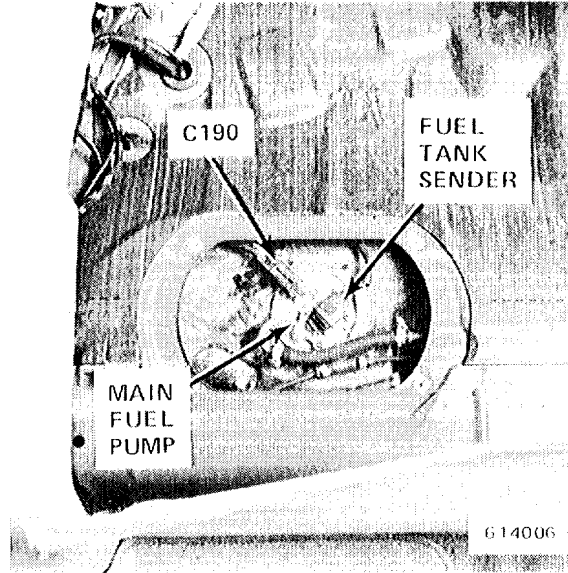

Figure 3 - Below RH Side of Rear Seat

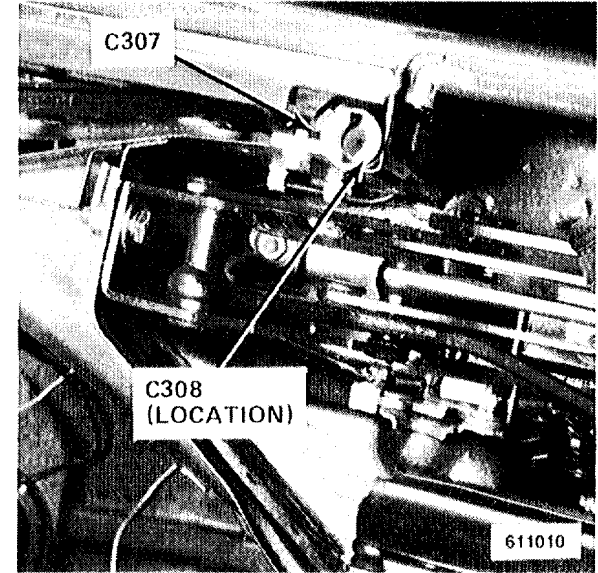

Figure 5 - RH Side of Soft Top Stowage Compartment

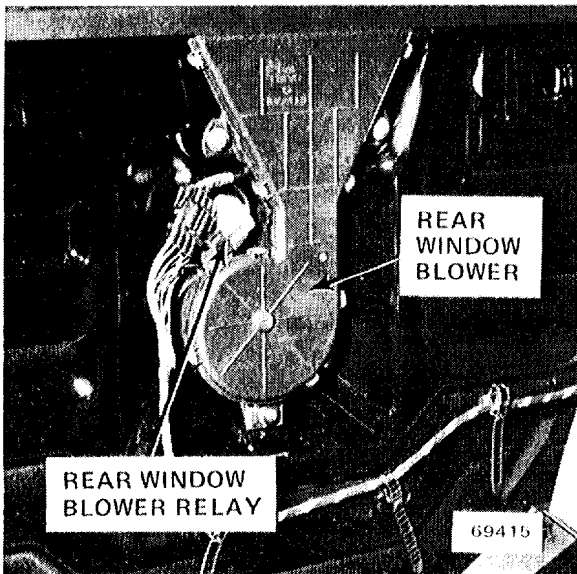

Figure 2 - Behind Center of Rear Seat

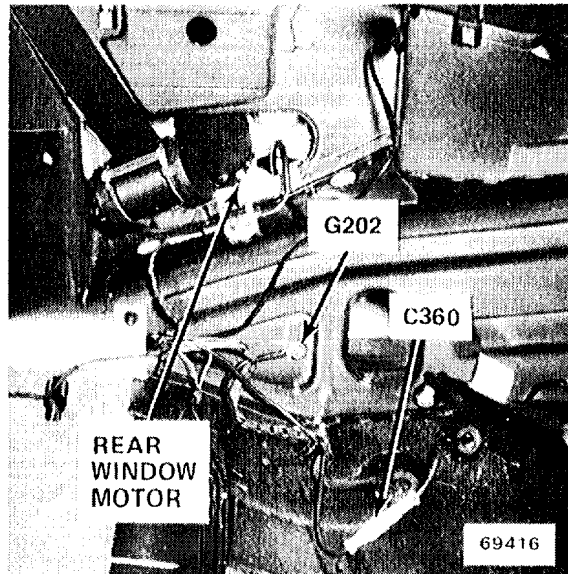

Figure 4 - RH Rear of Passenger Compartment (LH Similar)

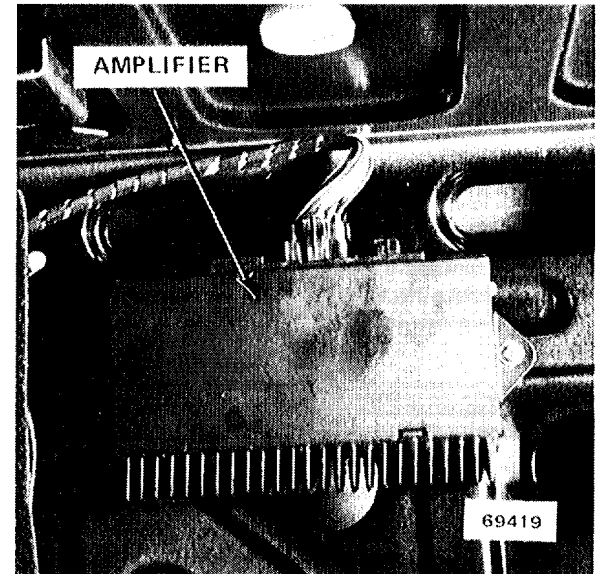

Figure 6 - LH Front of Trunk

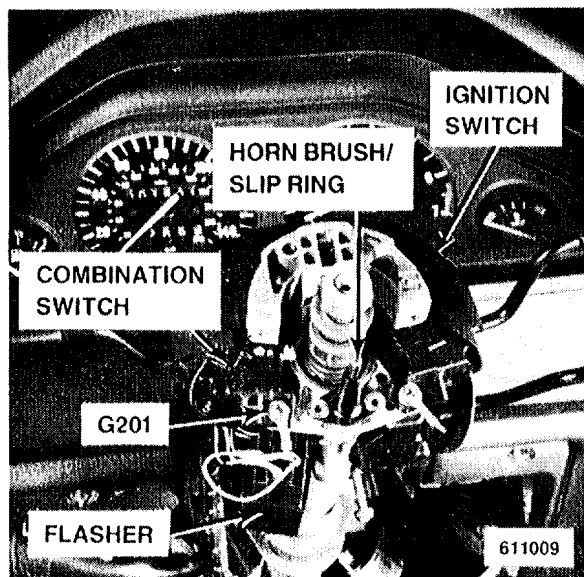

Figure 1 - LH Side of Trunk



Figure 3 - Center Rear of Trunk

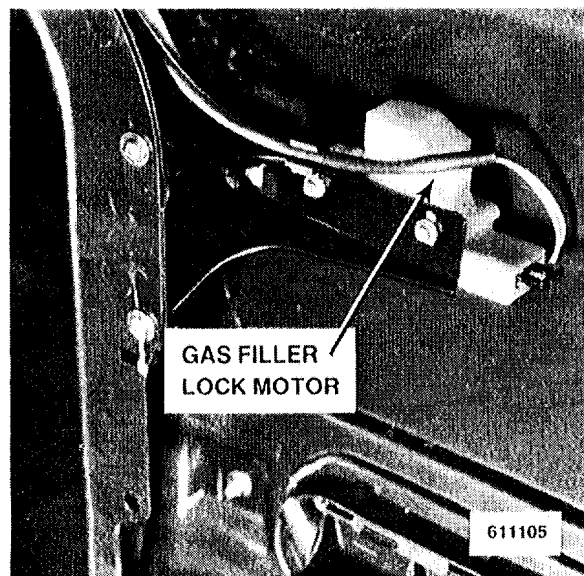

Figure 2 - RH Side of Trunk

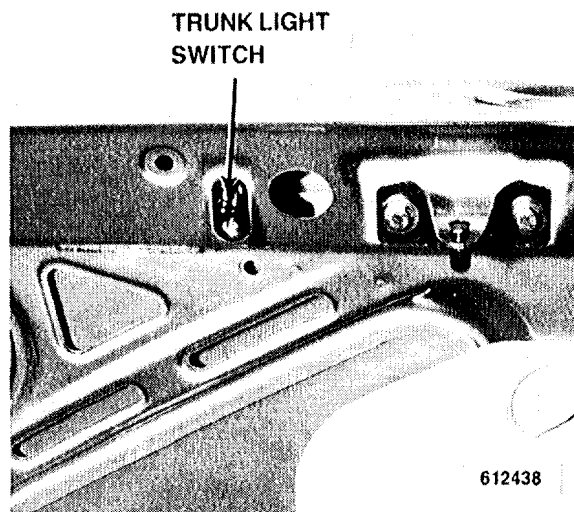

Figure 4 - LH Rear of Trunk Lid

8000-0 SPLICE LOCATION VIEWS

INDEX

This index lists all the splices in the vehicle, the harness location of each splice, and the page on which each splice appears. The drawings after the index show how the harnesses are routed through the vehicle and the location of the splices on the harnesses.

SPLICE	HARNESS	PAGE NUMBER	SPLICE	HARNESS	PAGE NUMBER
S100	MAIN	8000-2	S229	AIR CONDITIONING	NOT SHOWN
S101	ENGINE	8000-3	S230	MAIN	8000-2
S104	ENGINE	8000-3	S231	MAIN	8000-2
S105	ENGINE	8000-3	S232	MAIN	8000-2
S106	ENGINE	8000-3	S233	MAIN	8000-2
S107	ENGINE	8000-3	S234	MAIN	8000-2
S108	ENGINE	8000-3	S235	MAIN	8000-2
S109	ENGINE	8000-5	S236	MAIN	8000-2
S111	ENGINE	8000-3	S237	MAIN	8000-2
S112	ENGINE	8000-3	S239	MAIN	8000-2
S113	ENGINE	8000-3	S240	AIR CONDITIONING	NOT SHOWN
S114	MAIN	8000-2	S250	AIR CONDITIONING	NOT SHOWN
S115	MAIN	8000-2	S251	AIR CONDITIONING	NOT SHOWN
S116	MAIN	8000-2	S252	AIR CONDITIONING	NOT SHOWN
S118	MAIN	8000-2	S260	MAIN	8000-2
S119	MAIN	8000-2	S300	DOOR	8000-4
S120	ENGINE	8000-3	S301	DOOR	8000-4
S201	ON-BOARD COMPUTER	8000-6	S302	DOOR	8000-4
S202	ON-BOARD COMPUTER	8000-6	S303	DOOR	8000-4
S207	MAIN	8000-2	S305	DOOR	8000-4
S209	MAIN	8000-2	S306	INSTRUMENT PANEL	8000-5
S210	MAIN	8000-2	S307	INSTRUMENT PANEL	8000-5
S211	MAIN	8000-2	S308	DOOR	8000-4
S212	MAIN	8000-2	S309	DOOR	8000-4
S213	MAIN	8000-2	S310	MAIN	8000-2
S215	MAIN	8000-2	S312	MAIN	8000-2
S219	INSTRUMENT PANEL	8000-5	S313	MAIN	8000-2
S221	INSTRUMENT PANEL	8000-5	S316	MAIN	8000-2
S228	CRUISE CONTROL	NOT SHOWN	S319	DOOR	8000-2
			S322	DOOR	8000-4

SPLICE	HARNESS	PAGE NUMBER
S324	MAIN	8000-2
S327	MAIN	8000-2
S329	MAIN	8000-2
S330	MAIN	8000-2
S332	DOOR	8000-3
S333	DOOR	8000-4
S340	MAIN	8000-2
S342	DOOR	8000-4
S345	RADIO	NOT SHOWN
S346	MAIN	8000-2
S400	RADIO	NOT SHOWN
S403	RADIO	NOT SHOWN
S404	RADIO	NOT SHOWN
S411	DOOR	8000-4
S420	RADIO	NOT SHOWN
S501	DOOR	8000-4
S502	DOOR	8000-4
S503	DOOR	8000-4
S504	DOOR	8000-4
S540	HEATED SEATS	NOT SHOWN
S541	HEATED SEATS	NOT SHOWN
S542	HEATED SEATS	NOT SHOWN
S543	HEATED SEATS	NOT SHOWN
S700	ENGINE	8000-3
S701	ENGINE	8000-3
S702	ENGINE	8000-3
S703	ENGINE	8000-3

8000-2 SPLICE LOCATION VIEWS

MAIN HARNESS SPLICE LOCATIONS

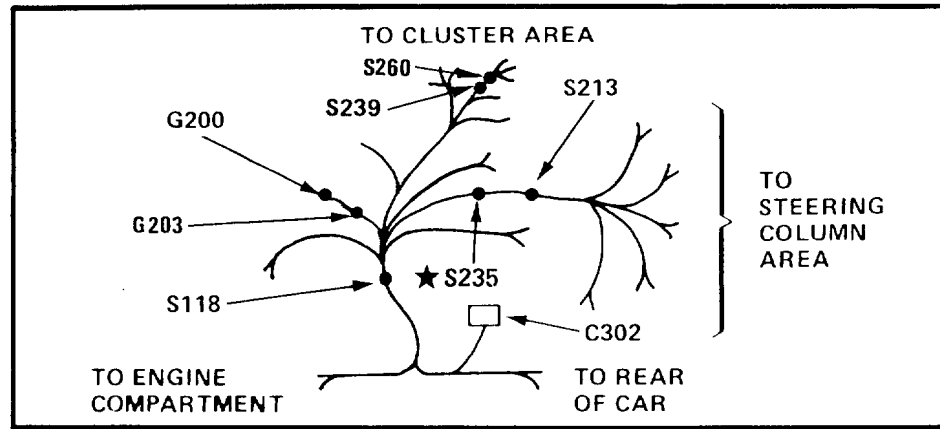

★ S235 MAY NOT EXIST ON ALL VEHICLES

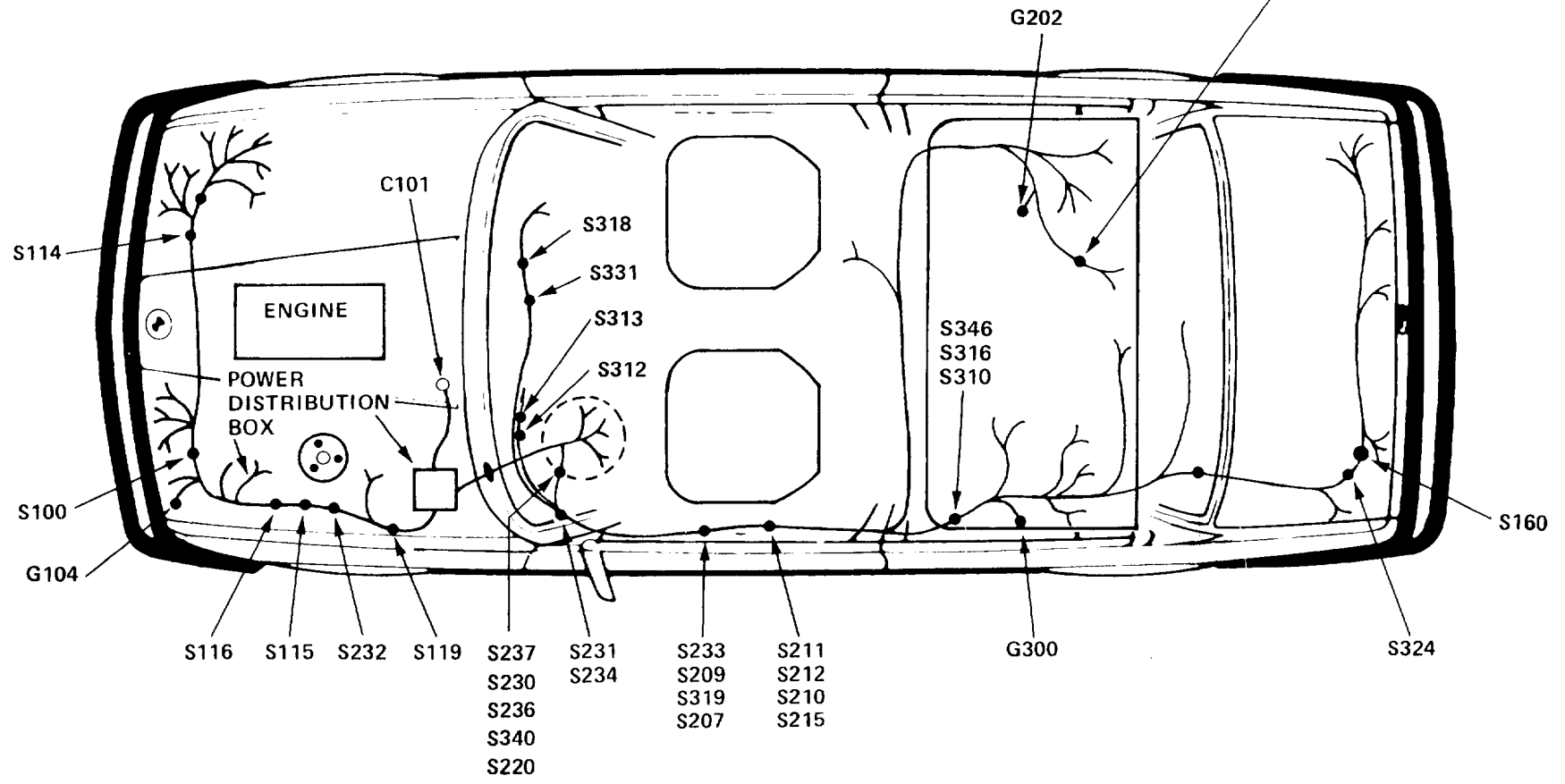

ENGINE HARNESS SPLICE LOCATIONS

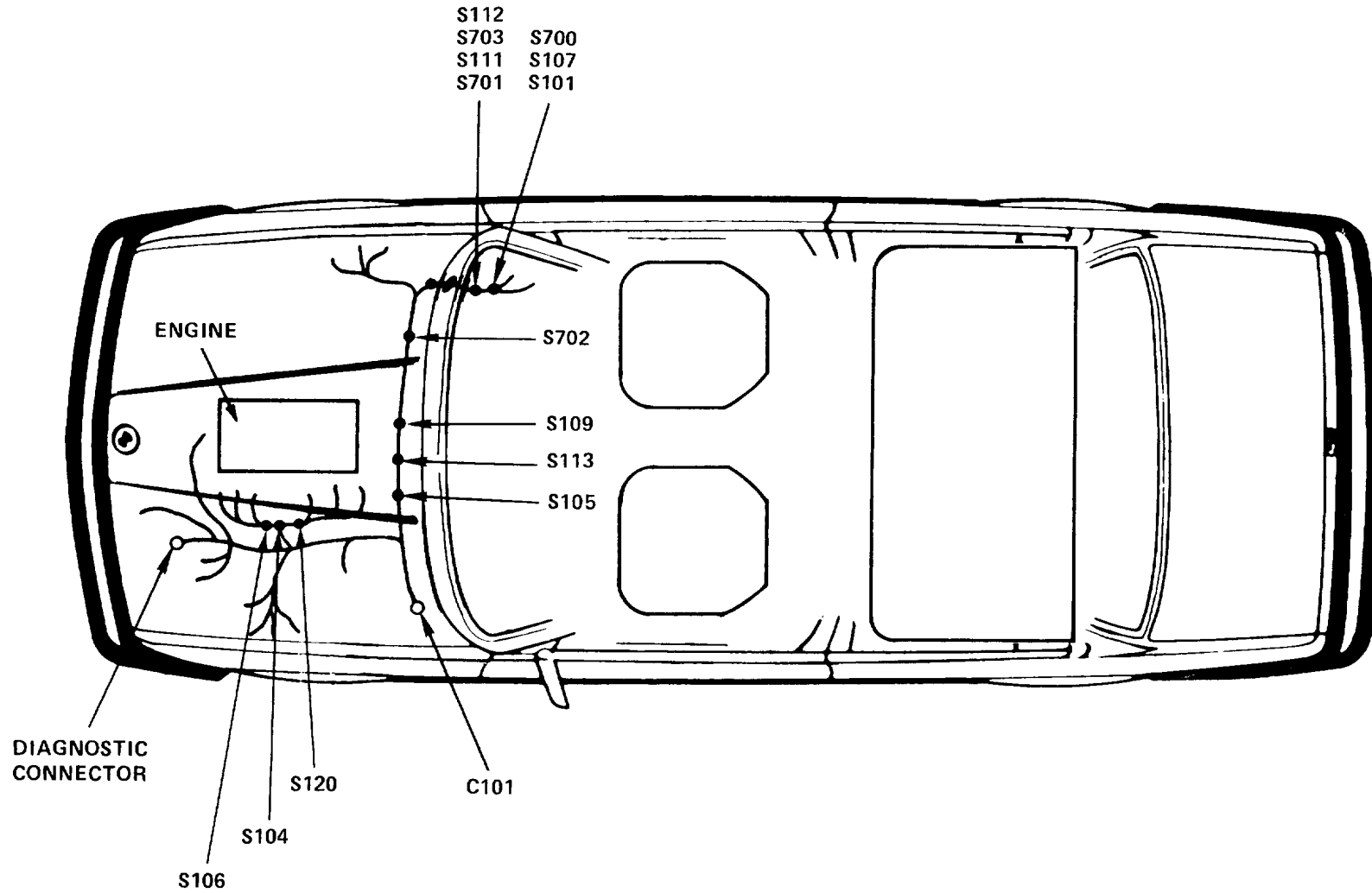

8000-4 SPLICE LOCATION VIEWS

DOOR HARNESS SPLICE LOCATIONS

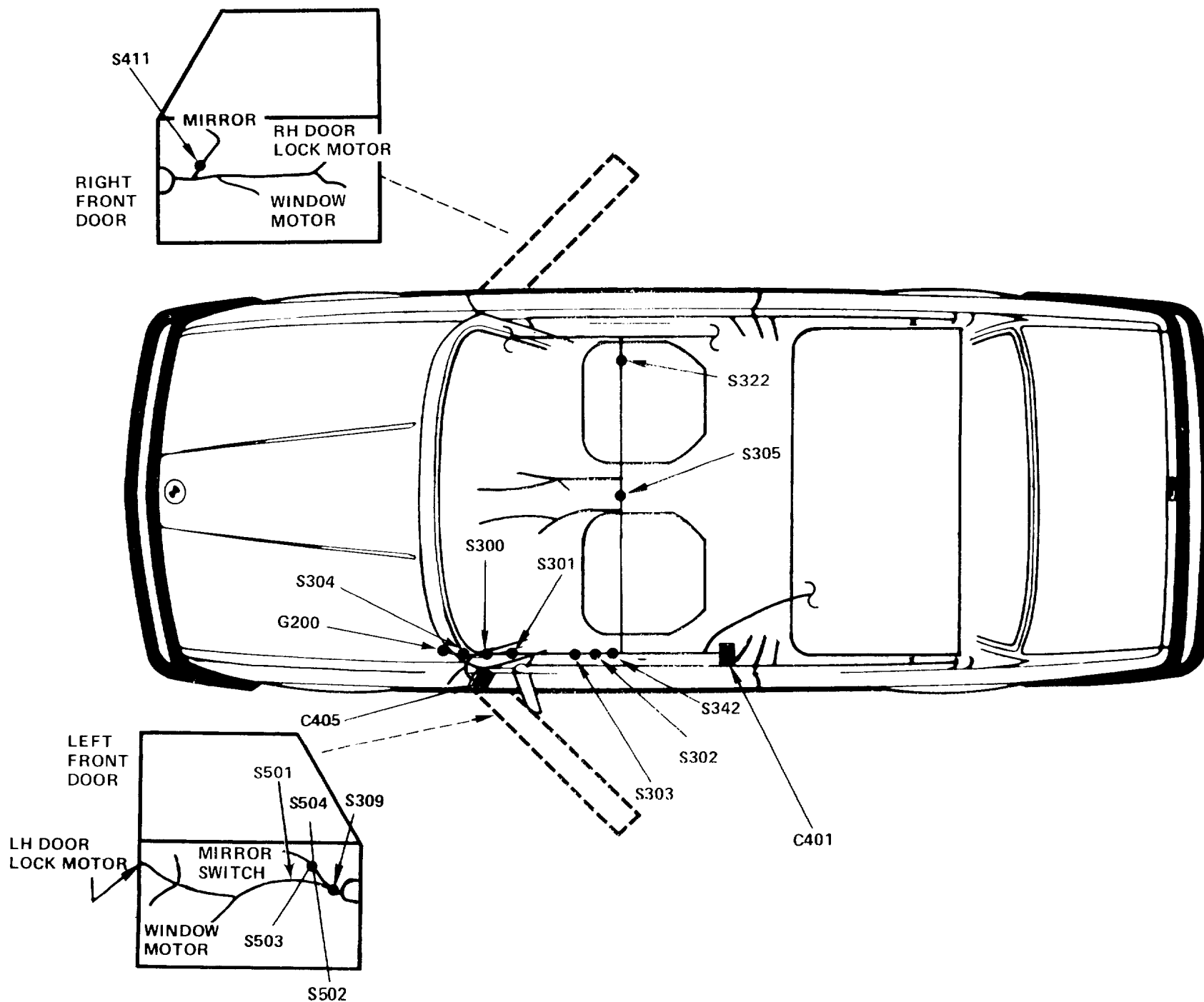

INSTRUMENT PANEL HARNESS SPLICE LOCATION

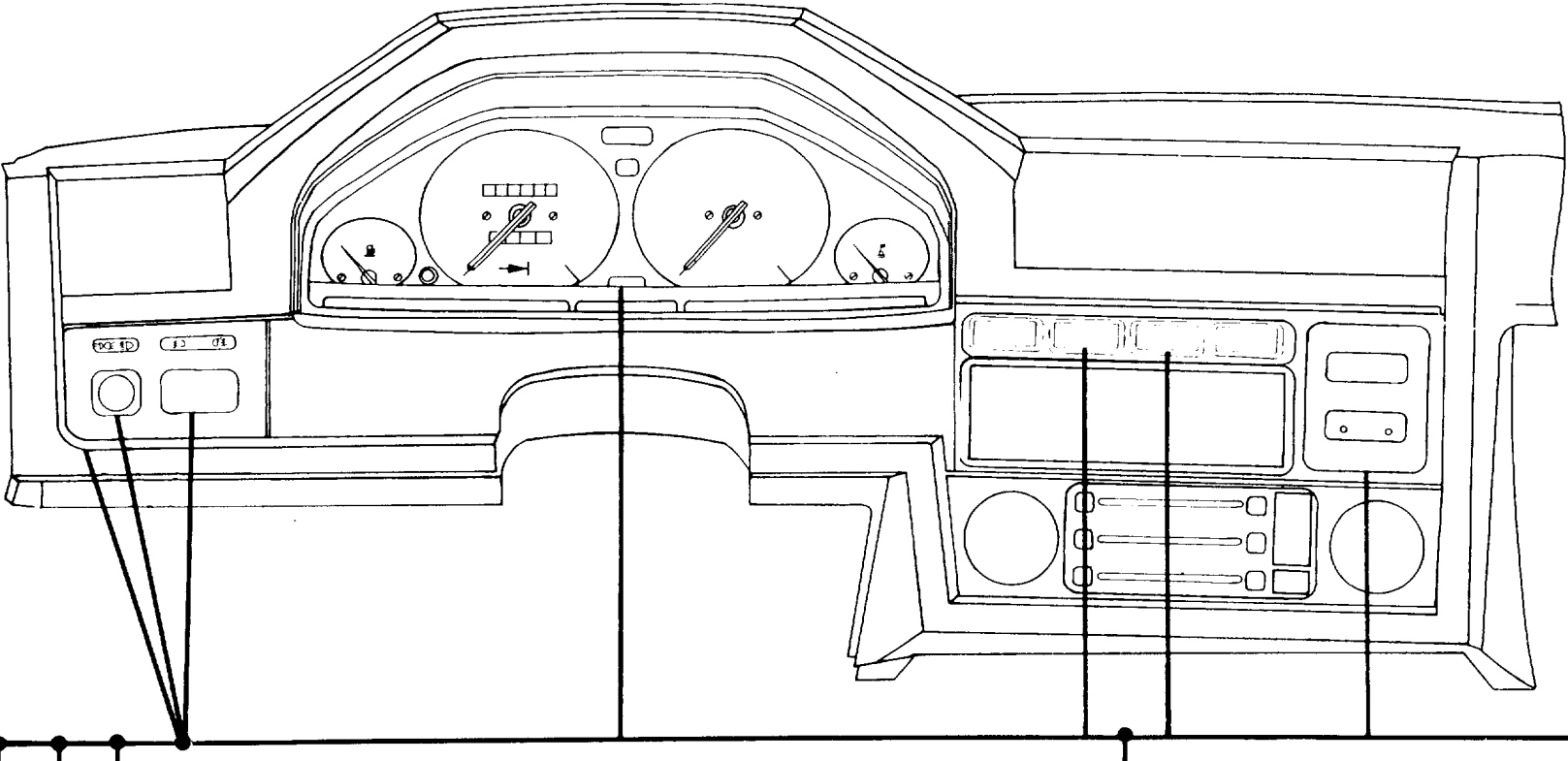

C103

S306

S307

S221

S219

8000-6 SPLICE LOCATION VIEWS

ON-BOARD COMPUTER HARNESS SPLICE LOCATIONS

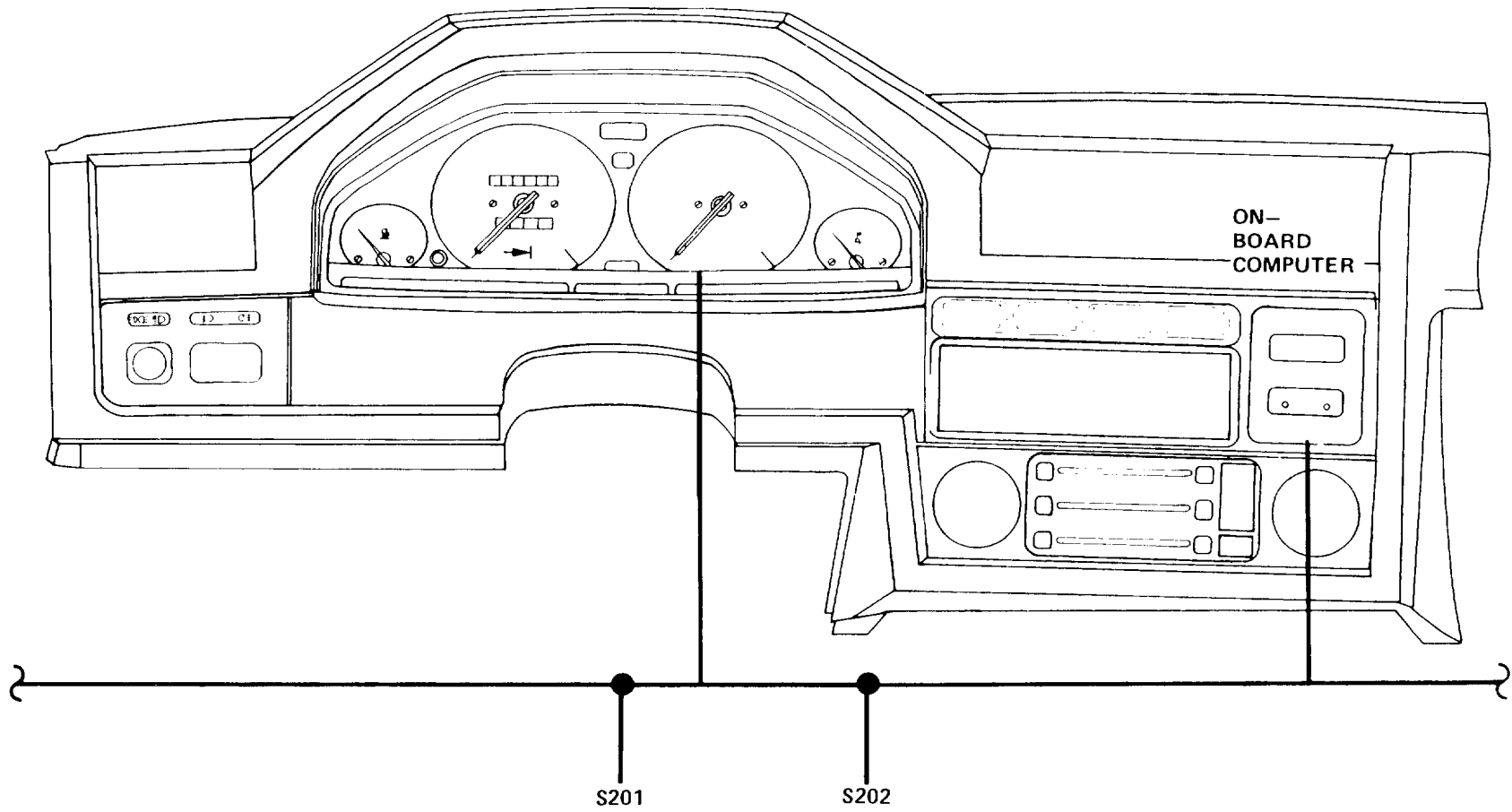

8500-0 CONNECTOR VIEWS

DIAGNOSTIC CONNECTOR

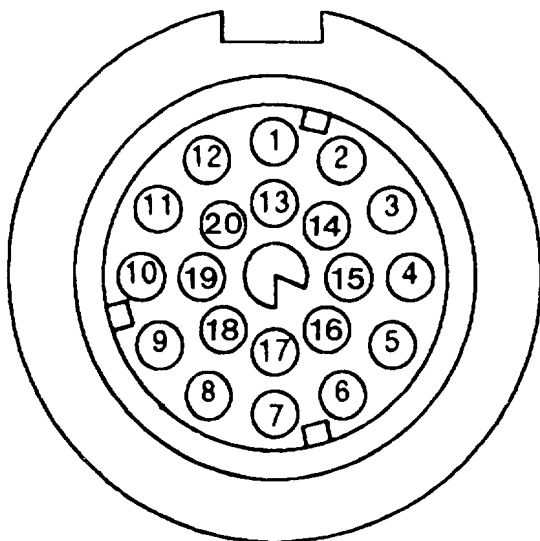

DIAGNOSTIC CONNECTOR FACE

Pin	Wire Size	Wire Color	Circuit and Component Connected
1	1	BK	Ignition Coil, Motronic Control Unit
6	.5	WT/BK	SRS Connector
7	.5	WT/BU	Service Interval Indicator, Service Interval Processor (Reset)
11	2.5	BK/YL	Starter, Start Signal (50)
12	.75	BU	Charge, Alternator (D+)
14	2.5	RD	Battery (+)
15	.5	BK/YL	Motronic Control Unit (RXD)
16	1.5	GN/WT	Oxygen Sensor/Power (318is)
18	.5	GN/BU	Motronic Control Unit (Programming Voltage)
19	1.5	BR	Ground Distribution (G103)
20	.5	WT/VI	Motronic Control Unit (TXD)

ACCESSORY CONNECTOR

CIRCUITS USING C302 (ACCESSORY CONNECTOR)

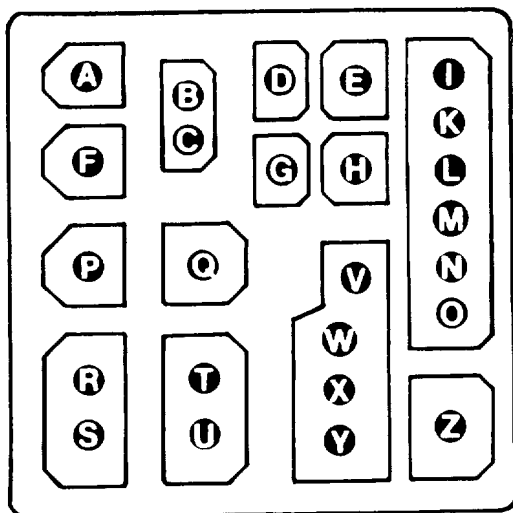
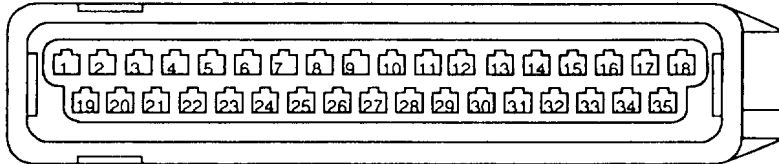

Figure 1-C302 (Accessory Connector)
Front View—Under LH Side
of Dash Ahead of Pedal Assembly

TERMINAL	CIRCUIT	TERMINAL	CIRCUIT
A	Not Used	N	Not Used
B	Not Used	O	Not Used
C	Anti-Lock Braking	P	Not Used
D	Not Used	Q	Power Windows
E	Not Used	R	Anti-Lock Braking
F	Not Used	S	Cruise Control
G	Anti-Lock Braking	T	Not Used
H	Multifunction Clock	U	Not Used
I	Not Used	V	Radio
J	Not Used	W	Radio
K	Not Used	X	Radio
L	Not Used	Y	Radio
M	Not Used	Z	Power Antenna

8500-2 CONNECTOR VIEWS

B350002.04



Mating Face
ABS CONTROL UNIT

B070008.00

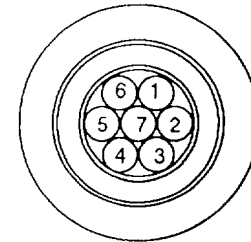

Mating Face
AIR FLOW METER
318is

B120014

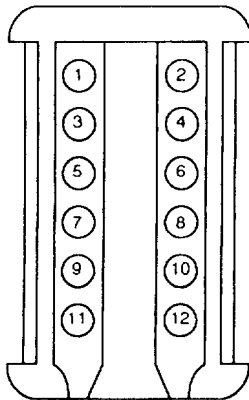

Wiring Face
ABS HYDRAULIC UNIT

B090001.14

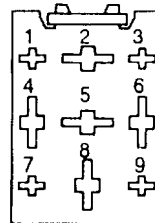

Mating Face
ABS NEUTRAL
INPUT RELAY

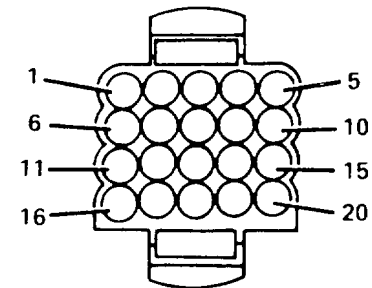

Wiring Face
AMPLIFIER
(SOUND SYSTEM)

B050010.00

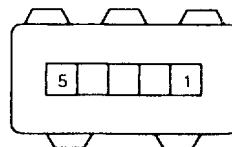

Mating Face
AIR FLOW METER
325i/is, M3, 325ix, 325ic

B080012

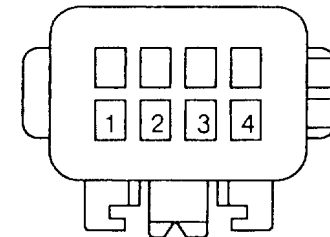

Wiring Face
AUXILIARY FUSE

B260002.01

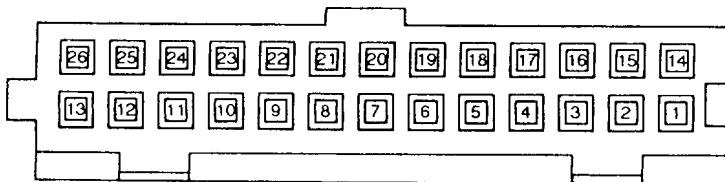

Mating Face
ACTIVE CHECK CONTROL

B090005

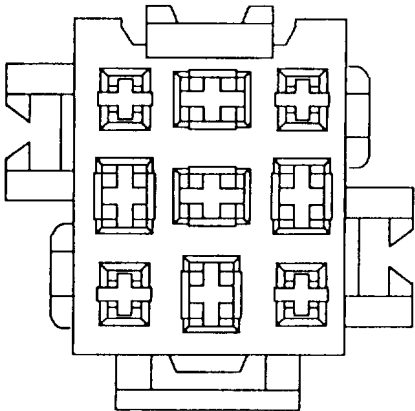

Mating Face
A/C COMPRESSOR CONTROL UNIT
318is

B260002.03

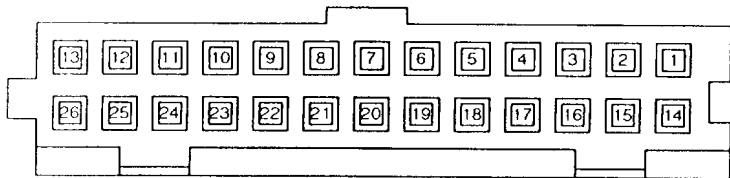

Wiring Face
CRUISE CONTROL
UNIT

B080014.00

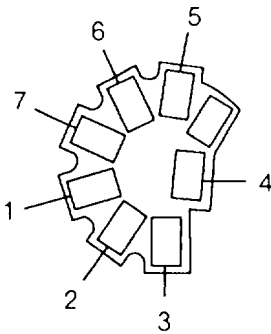

Wiring Face
BLOWER SPEED CONTROL

B030015.03

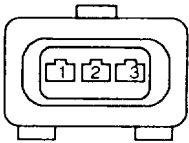

Wiring Face
BAROMETRIC PRESSURE
SENSOR



Wiring Face
CHIME MODULE (C1)

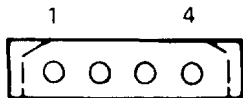

Wiring Face
BLOWER RESISTORS

B040013

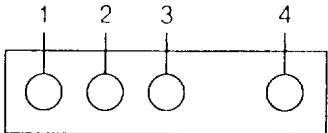

Wiring Face
CHIME MODULE (C2)

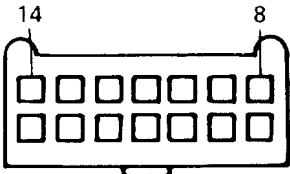

Wiring Face
CENTRAL LOCKING CONTROL UNIT

8500-4 CONNECTOR VIEWS

B080013.00

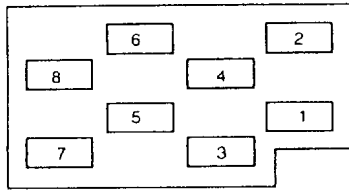

Wiring Face

CONTROL SWITCHES

B030019.00

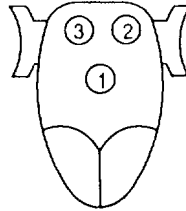

Wiring Face

DUAL TEMPERATURE SWITCH

B060024

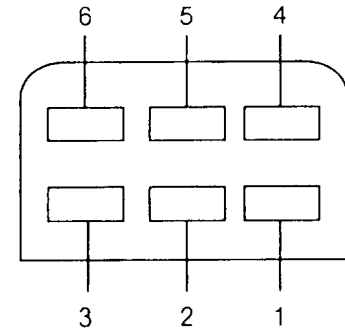

Wiring Face

EVAPORATOR TEMPERATURE
REGULATOR

B030015.05

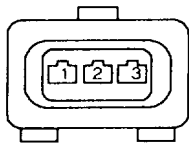

Mating Face

CYLINDER IDENTIFICATION
SENSOR

B030015.04

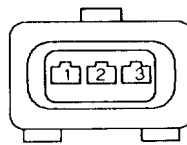

Wiring Face

ENGINE SPEED SENSOR

49A

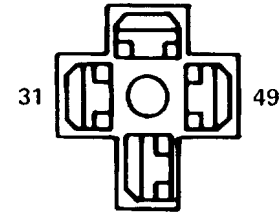

Wiring Face

FLASHER

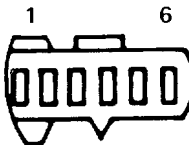

Wiring Face

DOOR LOCK MOTOR

B090001.04

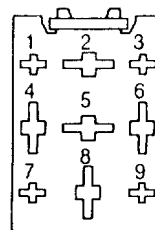

Mating Face

EVAPORATIVE
PURGE VALVE RELAY

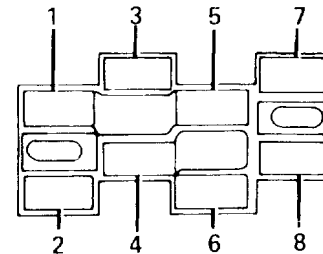

Wiring Face

FOG LIGHT SWITCH

B090001.17

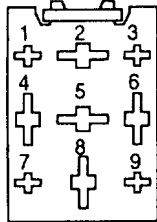

Mating Face

FRESH/RECIRCULATING AIR RELAY

B030017.00

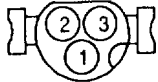

Wiring Face

FRONT TURN/PARK LIGHT

325i/325is, 325ix

B030025.00

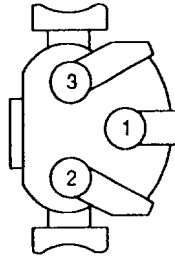

Mating Face

FRONT TURN/PARK LIGHT

318is

B030015.09

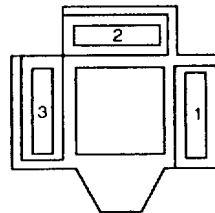

Mating Face

HEADLIGHTS

Low and High Beams

B030020.00

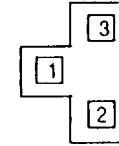

Wiring Face

INSTRUMENT CLUSTER (C6)

B090001.16

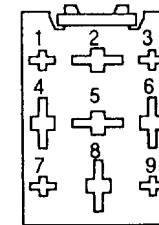

Mating Face

INTERIOR LIGHT TIMER CONTROL

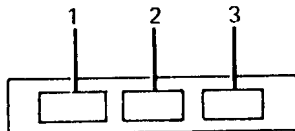

Wiring Face

FRONT TURN/PARK LIGHT

325ic, M3

B030015.08

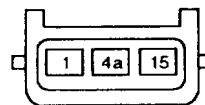

Mating Face

IGNITION COILS

318is

B120006.00

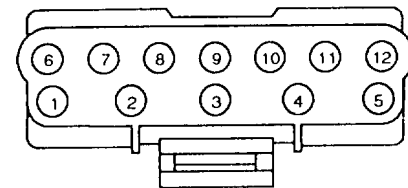

Wiring face

LIGHT SWITCH

8500-6 CONNECTOR VIEWS

B090001.06

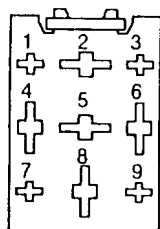

Mating Face
MAIN RELAY

2 6

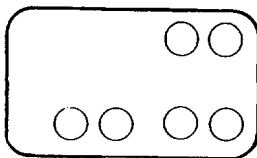

Mating Face
MIRROR CONTROL SWITCH

B030015.06

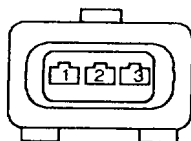

Wiring Face
OIL LEVEL SENSOR

B550001.02

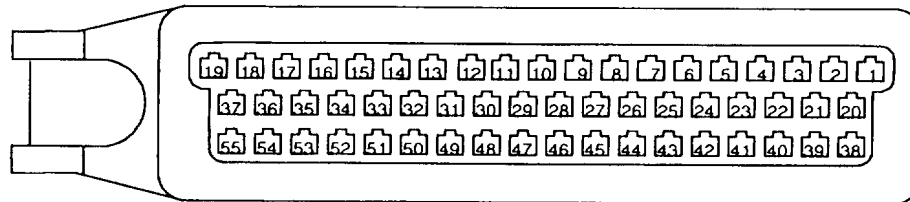

Mating Face
MOTRONIC CONTROL UNIT
All except M3 and 318is

B350002

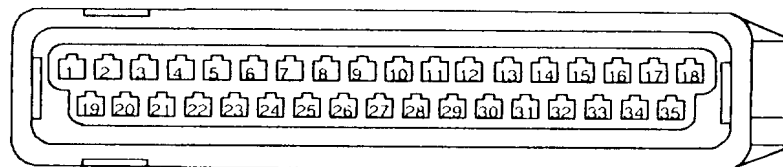

Mating Face
MOTRONIC CONTROL UNIT

B880002.00

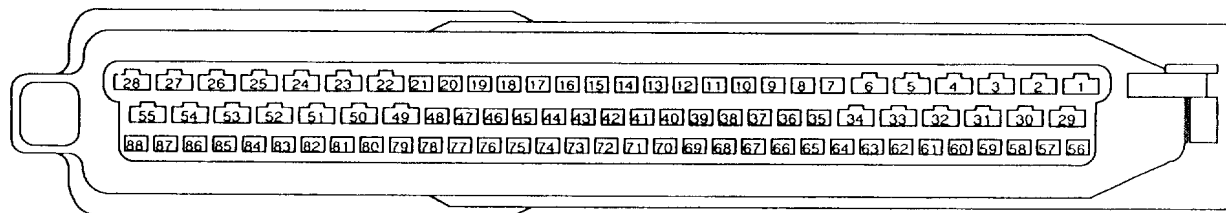

Mating Face
MOTRONIC CONTROL UNIT
318is

B260002.00

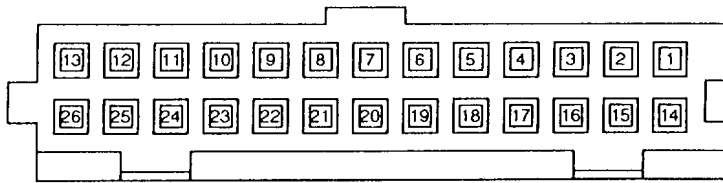

Wiring Face

ON - BOARD COMPUTER MODULE

B090001.05

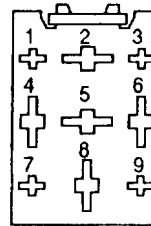

Mating Face

OXYGEN SENSOR HEATER RELAY

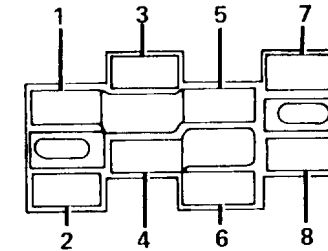

Wiring Face

REAR DEFOGGER SWITCH

B040012.02

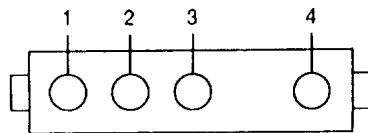

Wiring Face

ON - BOARD COMPUTER
RELAY BOX (C2)

B040012.01

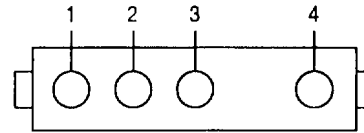

Wiring Face

POWER MIRRORS

B060027.00

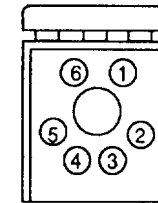

Wiring Face

REAR LIGHT ASSEMBLY

B040018

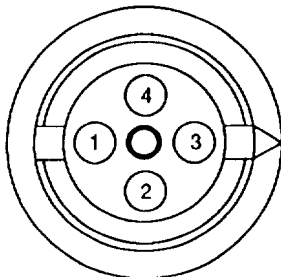

Mating Face

OXYGEN SENSOR HEATER
318is

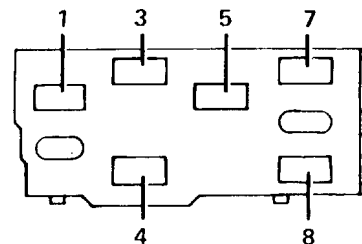

Wiring Face

POWER WINDOW SWITCHES

B060033.00

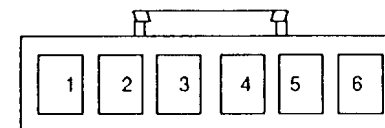

Wiring Face

REAR LIGHT ASSEMBLY

8500-8 CONNECTOR VIEWS

B080015.01

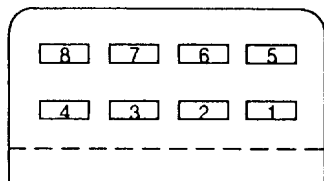

Wiring Face

REAR LIGHTS CHECK RELAY (C1)

B090001.14

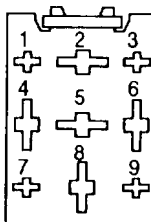

Mating Face

REAR WINDOW BLOWER RELAY

B090001.00

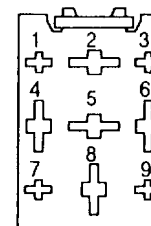

Wiring Face

START RELAY

B060028 .01

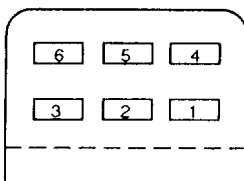

Wiring Face

REAR LIGHTS CHECK RELAY (C2)

B090001.05

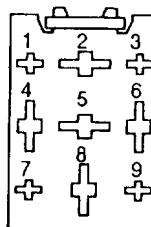

Mating Face

SEATBELT WARNING TIMER



Wiring Face

SUNROOF MOTOR (C1)

B0400002.03

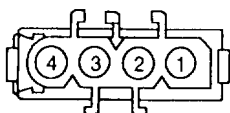

Mating Face

REAR WINDOW BLOWER

B070009.00

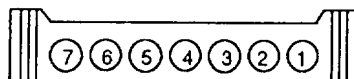

Mating Face

SEATBELT AND SRS WARNING MODULE
318is

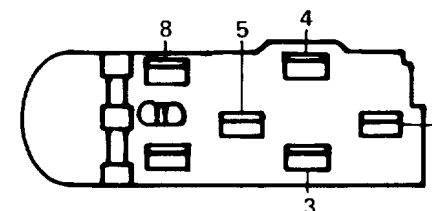

Wiring Face

SUNROOF SWITCH

B030015.07

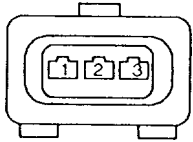

Wiring Face

THROTTLE SWITCH, POTENTIOMETER

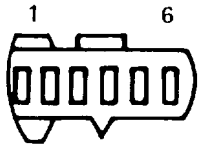

Wiring Face

TRUNK LID LOCK MOTOR

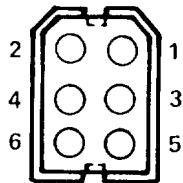

Wiring Face
WIPER MOTOR

B200002.00

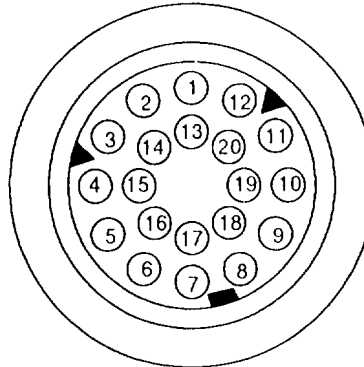

Wiring Face

C101

B300001.00

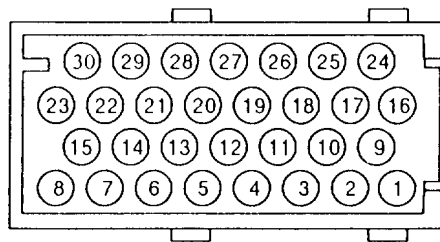

Wiring Face

C103

B030004.02

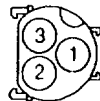

Mating Face

C110

C113



Wiring Face

C114

B040002.00

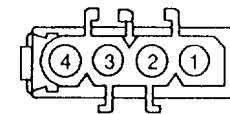

Wiring Face

C107

C131

C136

C270

B040006.01

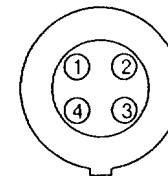

Wiring Face

C140

8500-10 CONNECTOR VIEWS

B030015.06

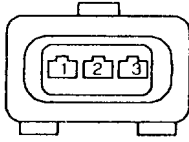

Wiring Face
C152, C153, C154

B070002.00

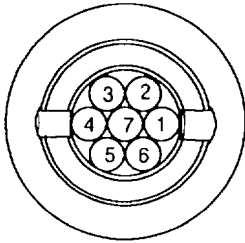

Wiring Face
C191

1 3 5 7

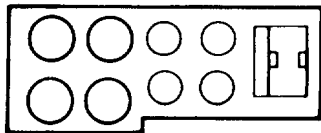

Wiring Face
C200

6 1



Wiring Face
C201

7 13

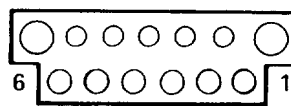

Wiring Face
C202

B060032.00

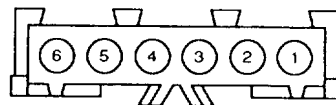

Wiring Face
C203

B120004.00

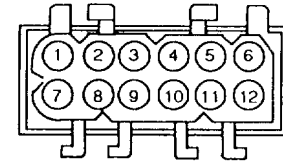

Wiring Face
C204

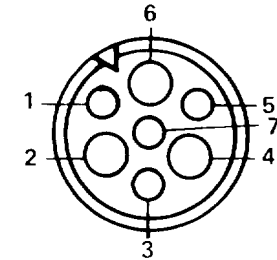

Wiring Face
C209

B070004.00

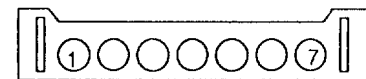

Wiring Face
C210

B060003.03

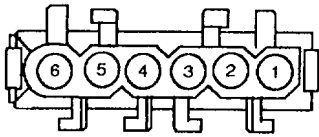

X75 OR

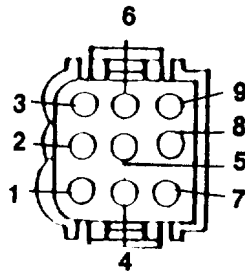

Wiring Face

C306

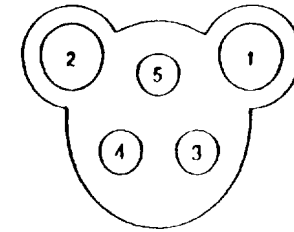

Wiring Face

C413

B080002.00

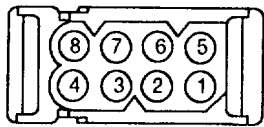

Mating Face

C243

C280

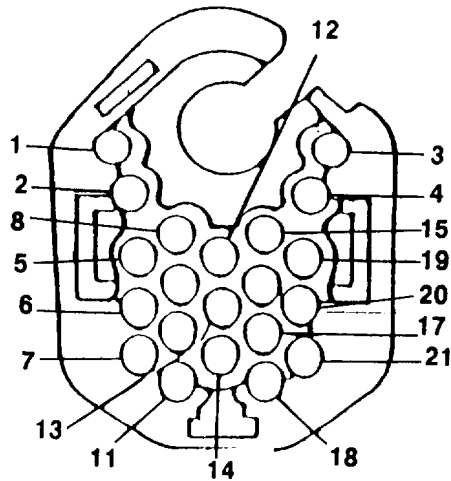

Wiring Face

C404

C405

B040004.02

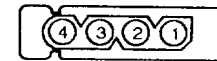

C170

C421

C422

B030001.01

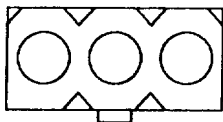

Wiring Face

C303

C405

3

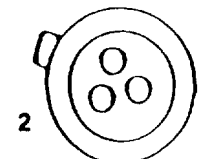

Wiring Face

C503

9000-0 COMPONENT LOCATION CHART

COMPONENTS		Page-Figure
A/C In-Line Fuse	LH rear side of evaporator housing	7000- 7-4
ABS Electronic Control Unit . . .	Behind LH side of dash, above hood release	7000- 6-3
ABS Hydraulic Unit	LH front corner of engine compartment	7000- 1-5
Active Check Control Unit	Above rear view mirror	7000- 8-2
Air Bag Gas Generator	Center of steering wheel	7000- 7-3
Air Flow Meter	LH front of engine compartment, behind air cleaner .	7000- 1-1
Alternator	Lower LH front of engine	7000- 2-1
Amplifier	LH front corner of trunk	7000-11-6
Auto-Charging Flashlight	Inside LH side of glove box	7000- 9-1
Automatic Transmission Range Switch	At base of gear shift lever	7000- 8-5
Auxiliary Fan	In front of radiator	7000- 2-3
Auxiliary Fan Normal Speed Blower Resistor	In front of radiator, LH side of auxiliary fan	7000- 2-3
Auxiliary Fuse	LH rear of engine compartment, on power distribution box	7000- 0-1
Back Up Light Switch	Top RH side of transmission	7000- 4-6
Battery	RH rear corner of engine compartment	7000- 4-3
Blower Motor	Inside fresh air intake cowl	7000- 0-4
Blower Resistors	Inside fresh air intake cowl, inside blower motor housing	
Board Computer Horn	Behind LH corner of front bumper	
Brake Fluid Level Switch	LH side of engine compartment, on brake fluid reservoir	7000- 0-3
Brake Switch	Behind LH side of dash, on brake pedal support . . .	7000- 6-3
Brake Wear Sensors	On LH front and RH rear brake calipers	7000- 4-5
Central Locking Control Unit . . .	Inside LH kick panel, below LH front speaker	7000- 5-3
Chime Module	Mounted on LH dash hush panel	7000- 6-2
Clutch Switch	Behind LH side of dash, on clutch pedal support . . .	7000- 6-3
Combination Switch	Upper LH side of steering column	7000- 7-2
Compressor Clutch	Lower RH front of engine, on A/C compressor	7000- 3-2
Compressor Clutch Diode	Lower RH front of engine, on A/C compressor	7000- 3-2
Convertible Switch I	In trunk, behind RH side of center trim panel	

Convertible Switch II	In trunk, behind RH side of center trim panel	
Convertible Top Cover Motor . .	In trunk, behind center of center trim panel	
Convertible Top Motor	In trunk, behind RH side of center trim panel	
Convertible Top Position Switch	LH side of soft top stowage compartment	7000-10-5
Coolant Level Switch	Front of LH front wheel well, in coolant reservoir. . .	7000- 1-4
Coolant Temperature Sender . . .	Top front of engine, top of thermostat housing	7000- 2-5
Coolant Temperature Sensor . . .	Top front of engine, top of thermostat housing	7000- 2-5
Cover Microswitch Close	In trunk, behind center of center trim panel	
Cover Microswitch Open	In trunk, behind center of center trim panel	
Cruise Control Actuator	LH front corner of engine compartment	7000- 1-4
Cruise Control Unit	Behind RH side of dash, above glove box	7000- 9-2
Cylinder Identification Sensor . .	Top RH front of engine, near distributor	7000- 2-6
Dead Point Microswitch	RH side of windshield header	
Diagnostic Connector	Top LH front of engine	7000- 1-3
Door Lock Motors	Rear part of each door.	7000-10-2
Driver's Exterior Door Handle		
Switch	In top rear of LH front door	7000-10-1
Dual Temperature Switch	Top RH side of radiator	7000- 2-4
Electro-mechanical Convertible		
Top Control Unit	In trunk, behind center trim panel	
Engine Speed Sensor	Lower RH front of engine.	7000- 3-1
Evaporative Purge Valve	LH side of engine, below throttle body.	7000- 0-6
Evaporator Temperature		
Regulator	On LH side of evaporator housing	7000- 7-5
Evaporator Temperature Sensor.	On LH side of evaporator housing	7000- 7-5
Filter Capacitor	Lower LH front of engine, on alternator	7000- 2-1
Flasher.	Upper part of steering column	7000- 7-2
Fresh/Recirculating Air Flap Door		
Motors	Behind A/C face plate, on either side of evaporator housing.	7000- 7-6
Fresh/Recirculating Air Relays . .	Behind A/C face plate	7000- 8-1
Front Window Motors	Forward part of each door	7000- 9-5
Fuel Injectors	Below intake manifold, at each cylinder	7000- 2-5
Fuel Pump Relay	Front of LH front shock tower, on bracket	7000- 1-2
Fuel Tank Sender.	Below RH side of rear seat, top of fuel tank	7000-11-3

9000-2 COMPONENT LOCATION CHART

Gas Filler Lock Motor	RH side of trunk, behind RH wheel well	7000-12-2
Glove Box Light Switch	Behind RH side of dash, above glove box	7000- 9-2
Hazard Switch	In center of dash, above digital radio	7000- 8-3
Horn Brush/Slip Ring	In upper part of steering column	7000- 7-2
Horns	Behind LH corner of front bumper	
Hot Water Cut-Out Switch	Behind center of dash, near rotary temperature control	7000- 8-1
Idle Speed Actuator	Top LH side of engine	7000- 1-3
Ignition Coil	On RH front wheel well, forward of shock tower	7000- 4-1
Ignition Key Switch	Part of ignition switch, in upper part of steering column	
Ignition Switch	Top RH side of steering column	7000- 7-2
Interior Light Timer Control	Inside LH kick panel, below LH front speaker	7000- 5-3
Left Front Crash Sensor	LH side of engine compartment, front of shock tower	7000- 1-1
Left Tank Fuel Sender	Below LH side of rear seat	7000-11-1
Loop Contact Rings	Inside steering wheel, below air bag gas generator	7000- 7-1
Main Fuel Pump	Below RH side of rear seat, in fuel tank	7000-11-3
Main Relay	Front of LH front shock tower, on bracket	7000- 1-2
Motronic Control Unit	Behind RH side of dash, above glove box	7000- 9-2
Multi-Function Clock	Center of dash, RH side of digital radio	7000- 8-4
Oil Level Sensor	Top LH side of oil pan	7000- 1-6
Oil Pressure Switch	Lower RH front of engine, below oil filter	7000- 3-3
On-Board Computer Module	Center of dash, RH side of digital radio	7000- 8-4
On-Board Computer Relay Box	Behind LH side of dash, near ABS electronic control unit	7000- 6-1
Outside Temperature Sensor	Behind LH corner of front bumper, on splash guard	7000- 2-2
Oxygen Sensor	Lower RH rear of engine compartment, on exhaust manifold	7000- 4-2
Oxygen Sensor Heater Relay	Front of LH front shock tower, on bracket	7000- 1-2
Park Brake Switch	At base of parking brake	7000- 8-6
Power Antenna	LH side of trunk, behind LH wheel well	7000-12-1
Power Distribution Box	LH rear corner of engine compartment	7000- 0-1
Power Window Circuit Breaker	On center console, near gear shift lever	7000- 8-5
Pulse Wheels	On respective wheels, in brake housing	7000- 4-4

Rear Lights Check Relay	Inside front of LH rear quarter panel, behind trim panel	7000-10-6
Rear Window Blower	Behind center of rear seat back.	7000-11-2
Rear Window Blower Relay	Behind center of rear seat back, on rear window blower	7000-11-2
Rear Window Motors	Inside front of each rear quarter panel, behind trim panel	7000-11-4
Refrigerant Pressure Switch	Behind RH headlight, on receiver dryer.	7000- 3-5
RH Front Door Micro Switch	In top rear of RH front door	7000- 9-6
Right Front Crash Sensor	RH side of engine compartment, front of shock tower	7000- 4-1
Seatbelt Switch	In driver's seatbelt buckle assembly	
Seatbelt Tensioner Generator	In RH "B" pillar, part of seat belt assembly	
Seatbelt Warning Timer	Behind LH side of dash, on electrical bracket	7000- 6-4
Speed Detectors	On respective wheels, in brake housing	7000- 4-4
Speedometer Sender	On rear of rear differential	7000- 5-1
SRS Diagnostic Module	Behind LH side of dash, above ABS electronic control unit	7000- 5-4
Start Relay	Behind LH side of dash, on accessory connector bracket	7000- 5-5
Starter	Lower LH rear of engine	7000- 0-5
Throttle Switch	LH side of engine, below throttle body.	7000- 0-6
Trunk Lid Lock Motor	On trunk lock center support	7000-12-3
Trunk Light Switch	Top center of trunk lid	7000-12-4
Unlock Inhibit Switch	In top rear of LH front door	7000- 9-6
Washer Fluid Level Switch	Behind RH headlight, in windshield washer fluid reservoir	7000- 3-5
Washer Pump	Ahead of RH front wheel well, on washer fluid reservoir	7000- 3-6
Water Shut-Off Solenoid	LH side of evaporator housing	7000- 7-4
Wiper Motor	Inside LH side of fresh air intake cowl	7000- 0-4

CONNECTORS

C75 (6 Pins)	Behind LH side of dash, on SRS Diagnostic Module bracket	
------------------------	--	--

9000-4 COMPONENT LOCATION CHART

C101 (20 pins)	Next to power distribution box, mounted on engine dash	7000- 0-3
C103 (30 pins)	Behind LH side of dash, on body electrical bracket.	7000- 5-6
C104 (2 pins)	Behind LH side of dash, near accessory connector.	7000- 6-2
C110 (3 pins)	RH front of engine compartment.	7000- 3-5
C113 (3 pins)	LH front corner of engine compartment	7000- 1-5
C114 (8 pins)	LH rear corner of engine compartment, on power distribution box	7000- 0-2
C115 (2 pins)	LH rear corner of engine compartment, on power distribution box	7000- 0-2
C126 (3 pins)	LH front corner of engine compartment	7000- 1-5
C127 (3 pins)	RH front corner of engine compartment	7000- 3-4
C131 (2 pins)	Behind RH side of dash, above glove box	7000- 9-2
C136 (4 pins)	Behind RH side of dash, above glove box	7000- 9-2
C140 (4 pins)	Lower RH rear of engine compartment, under battery tray	7000- 4-2
C142 (1 pin)	Behind LH side of dash, near steering column	7000- 6-2
C143 (1 pin)	Behind LH side of dash, near accessory connector.	7000- 6-4
C150 (2 pins)	Front of LH front shock tower, on bracket	7000- 1-1
C151 (2 pins)	Front of RH front wheel well	7000- 3-6
C170 (4 Pins)	Behind LH side of dash	
C190 (2 pins)	Below RH side of rear seat	7000-11-3
C191 (7 pins)	Lower LH side of engine	7000- 0-5
C200 (10 pins)	Behind LH side of dash, on steering column	7000- 6-4
C201 (6 pins)	Behind LH side of dash, on steering column	7000- 6-4
C202 (13 pins)	Behind LH side of dash, on steering column	7000- 6-4
C203 (6 pins)	Behind LH side of dash, near LH kick panel.	7000- 5-3
C204 (12 pins)	Behind LH side of dash, RH side of steering column.	7000- 7-6
C208 (2 pins) (Automatic)	Behind LH side of dash, on C204	
C208 (2 pins) (Manual)	Behind LH side of dash, on brake pedal support.	7000- 6-3
C209 (7 pins)	Behind LH side of dash, near brake pedal support	7000- 6-2
C210 (7 pins)	Behind LH side of dash, on steering column	7000- 6-4
C213 (1 pin)	Behind center of dash, on digital radio	7000- 8-3
C214 (1 pin)	Behind center of dash, on digital radio	7000- 8-3
C215 (2 pins)	Behind center of dash, behind digital radio	7000- 8-4

C216 (2 pins)	Behind center of dash, on digital radio	7000- 8-4
C217 (1 pin)	Behind LH side of dash, near accessory connector	7000- 6-1
C219 (2 pins)	LH side of trunk, above LH wheel well	7000-12-1
C233 (1 pin)	Behind center of dash, near digital radio	7000- 8-4
C240 (6 pins)	Behind LH side of dash, on SRS diagnostic module bracket	7000- 5-4
C241 (1 pin)	Behind LH side of dash, above steering column	7000- 6-5
C242 (4 pins)	Behind center of dash, on digital radio	7000- 8-4
C243 (8 pins)	Behind center of dash, near digital radio	7000- 8-3
C260 (2 pins)	Underside of steering column, above access panel	7000- 6-6
C261 (2 pins)	Behind LH side of dash, near accessory connector	7000- 6-1
C270 (4 pins)	Behind LH side of dash, on SRS diagnostic module bracket	7000- 5-4
C280 (8 Pins)	Behind LH side of dash, on SRS Diagnostic Module bracket	
C290 (2 pins)	Behind LH side of dash, on SRS diagnostic module bracket	7000- 5-4
C301 (2 pins)	Below center console, near gear shift lever	7000- 8-5
C302 (25 pins) Accessory Connector	Behind LH side of dash, on body electrical bracket	7000- 5-6
C305 (1 pin)	Behind LH side of dash, near accessory connector	7000- 6-1
C306 (9 pins)	Below center console, near gear shift lever	7000- 8-5
C307 (1 pin)	RH side of soft top stowage compartment, on hard top mounting post	7000- 8-5
C308 (1 pin)	RH side of soft top stowage compartment, on hard top mounting post	7000-11-5
C310 (1 pin)	LH side of soft top stowage compartment, on hard top mounting post	7000-10-5
C352 (2 pins)	Below LH side of rear seat	7000-10-6
C360 (2 pins)	Below RH side of rear seat	7000-11-4
C404 (21 pins)	Above RH front door jamb switch	7000- 9-4
C405 (21 pins)	Above LH front door jamb switch	7000- 5-2
C406 (1 pin)	Below RH front speaker	7000- 9-3
C407 (1 pin)	Below LH front speaker	7000- 5-3
C413 (4 pins)	Top center of trunk, inside high level stop light assembly	

9000-6 COMPONENT LOCATION CHART

C360 (2 pins)	Below RH side of rear seat	7000-11-4
C404 (21 pins)	Above RH front door jamb switch	7000- 9-4
C405 (21 pins)	Above LH front door jamb switch	7000- 5-2
C406 (1 pin)	Below RH front speaker	7000- 9-3
C407 (1 pin)	Below LH front speaker	7000- 5-3
C413 (4 pins)	Top center of trunk, inside high level stop light assembly	
C421 (4 pins)	Below LH front seat assembly	7000-10-3
C422 (4 pins)	Below RH front seat assembly	7000-10-4
C500 (1 pin)	Behind LH side of dash, near steering column	7000- 6-2
C503 (3 pins)	In lower rear of LH front door	7000-10-2
C510 (1 pin)	Inside LH kick panel, above LH front speaker	7000- 5-3
GROUNDS		
G100	On RH shock tower	7000- 4-3
G103	On RH shock tower	7000- 4-3
G104	On inner fender, behind LH headlight	7000- 1-4
G200	Behind LH side of dash, above brake pedal	7000- 6-5
G201	Upper LH side of steering column	7000- 7-2
G202	Below RH side of rear seat	7000-11-4
G203	Under LH side of dash, above brake pedal	7000-06-5
G300	Below LH side of rear seat	7000-10-6
G302	LH side of trunk, behind LH wheel well	7000-12-1
G303	Under RH side of dash	
G304	In trunk, behind center trim panel	
